

SOLAR CARPARKS FOR ELECTRIC VEHICLE CHARGING IN A GRID WITH LIMITED CAPACITY

RISHABH GHOTGE

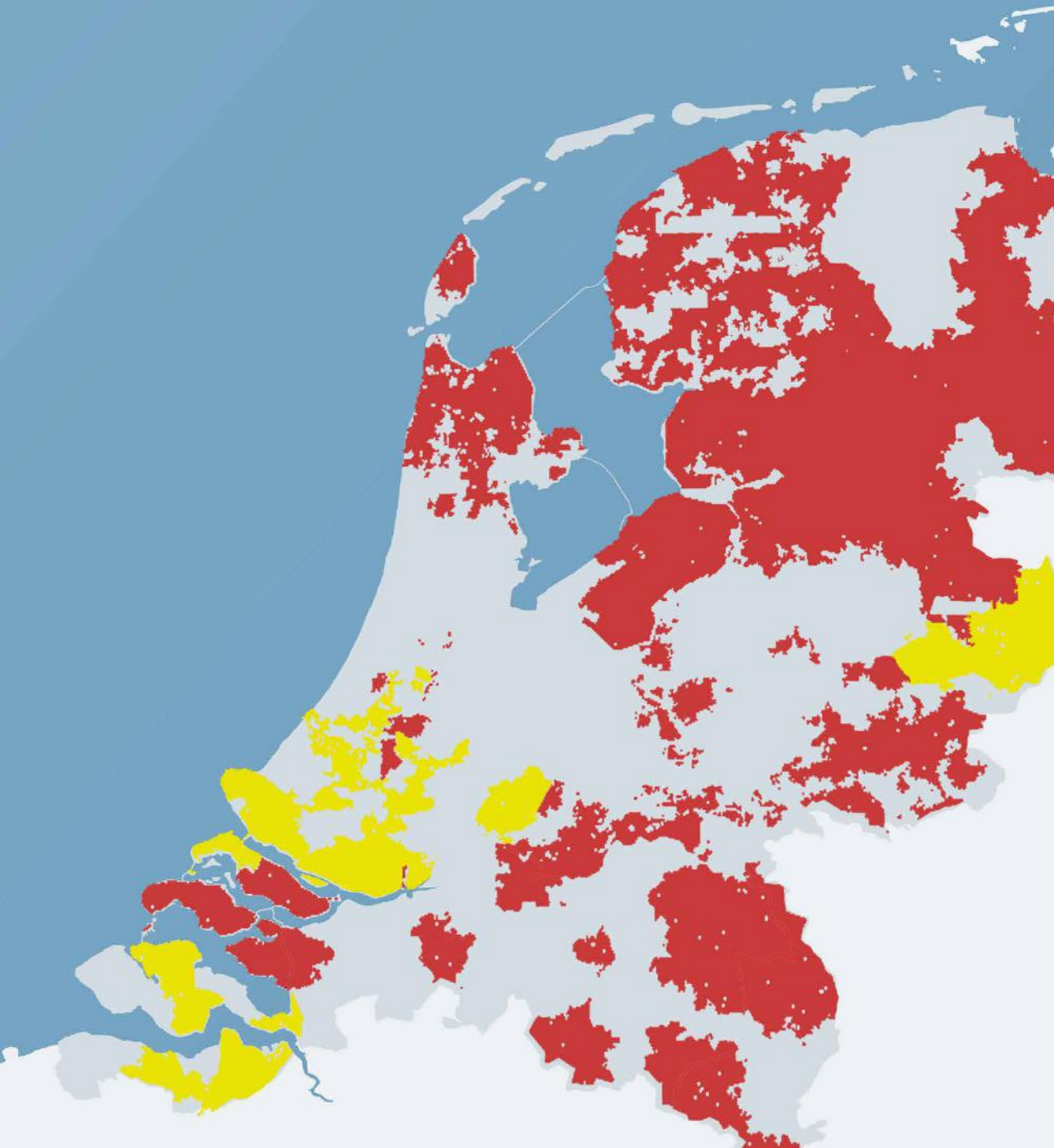

**SOLAR CARPARKS FOR ELECTRIC VEHICLE
CHARGING IN A GRID WITH LIMITED CAPACITY**

DISSERTATION

for the purpose of obtaining the degree of doctor
at Delft University of Technology
by the authority of the Rector Magnificus, Prof. dr. ir. T.H.J.J. van der Hagen
chair of the Board for Doctorates
to be defended publicly on
Monday, the 14th of November, 2022 at 12:30 o'clock

by

Rishabh GHOTGE

Master of Science in Renewable Energy,
Carl von Ossietzky Universität, Oldenburg, Germany
born in Pune, India.

This dissertation has been approved by the promotor.

Composition of the doctoral committee:

Rector Magnificus,	chairperson
Prof. dr. A.J.M. van Wijk,	Delft University of Technology, promotor
Prof. dr. ir. Z. Lukszo,	Delft University of Technology, promotor

Independent members:

Prof. dr. ir. A.H.M. Smets,	Delft University of Technology
Prof. dr. ir. B. van Arem,	Delft University of Technology
Prof. dr. W.G.J.H.M. van Sark,	Utrecht University
Prof. dr. F. Alkemade,	Eindhoven University of Technology
Dr. Ing. P. Frías Marín,	Comillas Pontifical University, Spain

This research was supported by the European Funds for Regional Development, under the Kansen voor West programme, under grant 00113.



EUROPEAN UNION
European Regional Development Fund

Cover design by: Varun Gokhale

Back cover image courtesy of: The Green Village

Printed by: Ridderprint | www.ridderprint.nl

Copyright © 2022 by Rishabh Ghotge, all rights reserved

ISBN 978-94-6366-616-9

An electronic version of this dissertation is available at

<https://doi.org/10.4233/uuid:db97669e-aaba-4fc7-900c-43bf7c6fcfd2>.

*To my parents, Nitya and Sanjeev,
and my sister, Nayantara.*

CONTENTS

SUMMARY	ix
SAMENVATTING	xiii
ACRONYMS	xvi
1 INTRODUCTION	1
1.1 Limited grid capacity: consequences for solar energy integration	1
1.2 Limited grid capacity: consequences for electric vehicle integration . . .	3
1.3 Solar carparks for EV charging	6
1.4 Research questions and thesis structure	7
1.5 Guide for readers	8
2 THEORY AND LITERATURE	13
2.1 Introduction	13
2.2 Overview of technologies	13
2.2.1 Solar photovoltaics: current status and recent trends	13
2.2.2 Solar carport structures	17
2.2.3 EV supply equipment and controlled charging	19
2.2.4 Vehicle-to-Grid (V2G) charge points	22
2.3 Actors involved in the EV charging ecosystem	23
2.4 Limitations of the current grid capacity to transport electricity	26
2.4.1 Estimated increase in demand for capacity	26
2.4.2 Consequences of violations of grid capacity constraints	28
2.4.3 What does grid reinforcement involve?	29
2.5 Thesis positioning and knowledge gap	33
2.6 Solar carparks for EV charging: a literature review	37
3 OPTIMISED SCHEDULING OF EV CHARGING IN SOLAR PARKING LOTS	49
3.1 Introduction	50
3.2 System description	51
3.2.1 Solar carports	52
3.2.2 Batteries	52
3.2.3 Electric vehicle supply equipment	53
3.2.4 Electric vehicle load profile	53
3.3 Methods for EV charge scheduling	55

3.3.1	Problem formulation with perfect forecasting	55
3.3.2	Inclusion of uncertainty in forecasting	58
3.3.3	No EV demand forecast	59
3.3.4	Average EV demand forecast	61
3.3.5	Robust EV demand forecast	62
3.4	Results and discussion	63
3.4.1	Example simulations	63
3.4.2	Maximum annual peak power exchanged with the grid	66
3.4.3	Duration of peak loads	68
3.5	Conclusions	69
4	OFF-GRID SOLAR CHARGING OF ELECTRIC VEHICLES AT LONG-TERM PARKING LOTS	77
4.1	Introduction	78
4.2	System description and data used	81
4.2.1	Solar PV Array and inverter	82
4.2.2	Charge points	83
4.2.3	Electric vehicles and their batteries	83
4.2.4	Vehicle occupancy at the parking lot	84
4.3	Immediate charging of the off-grid fleet	85
4.3.1	Formulation of immediate charging in the off-grid solar system	85
4.3.2	Adequacy of Charging	86
4.3.3	Critical month analysis	88
4.3.4	Increasing the adequacy of charging	89
4.4	Prioritised charging of vehicles	92
4.4.1	Formulation of priority based strategies	92
4.4.2	Comparison of prioritised charging approaches	96
4.4.3	Critical month analysis with the lowest SoC priority strategy	98
4.4.4	Combined strategies	99
4.4.5	Commercial application of off-grid solar parking lots for EV charging	100
4.5	Conclusions	100
5	OFFSETTING EMISSIONS AT SOLAR CARPARKS FOR EV CHARGING	107
5.1	Introduction	108
5.2	Solar carpark system description	110
5.2.1	Solar carpark system	111
5.2.2	Solar array	111
5.2.3	EV supply equipment	112
5.2.4	Nickel metal hydride battery	114

5.2.5	Nickel metal hydride battery dispatch and system operation . . .	115
5.3	Theory, Methods and Greenhouse Gas data	116
5.3.1	Definitions and scope	117
5.3.2	Market based and locational methods for emissions accounting .	119
5.3.3	Production and consumption based carbon allocation	119
5.3.4	Geographical granularity and consequences of trading	120
5.3.5	Temporal granularity and influence of charging profiles	121
5.3.6	The Attributional-Consequential distinction	121
5.3.7	Adopted methodology	123
5.3.8	Greenhouse gas emissions data	125
5.4	Results and Discussions	131
5.4.1	Operation of the solar carpark for EV charging	131
5.4.2	Annual carbon emissions and annual offset carbon emissions . .	133
5.4.3	Emissions offsetting enabled through battery cycling	136
5.4.4	Limitations of this work	138
5.4.5	Outlook on the future	139
5.5	Conclusions	140
5.6	Appendix A: Derivation of hourly energy flows	142
5.7	Appendix B: Annual Average Approach	145
5.8	Appendix C: Literature on GWP of solar photovoltaics	146
5.9	Appendix D: Literature on GWP of Ni-MH batteries	148
6	THE EFFECT OF PRICE-OPTIMISED CHARGING ON EV FLEET EMISSIONS	155
6.1	Introduction	156
6.2	System considered and scope	157
6.2.1	EV charge point data	157
6.2.2	Electricity Market price data	158
6.2.3	Time dependent carbon intensity data	159
6.3	Methods	160
6.3.1	Ex post EV scheduling	160
6.3.2	Calculation of Carbon Intensities	160
6.4	Results and Discussions	162
6.5	Conclusions	164
7	CONSUMER ACCEPTANCE OF V2G CHARGING	167
7.1	Introduction	168
7.2	Literature review and conceptual model	169
7.2.1	Theory of Planned Behaviour and conceptual model	173
7.3	Methods	175
7.3.1	Sampling of participants	175

7.3.2	Profiles of the sample population and representativeness	176
7.3.3	Semi-structured interviews	177
7.3.4	Participants' experience with V2G charging	178
7.3.5	Coding and data analysis	180
7.4	Results and Discussions	181
7.4.1	Factors influencing consumer acceptance of V2G charging	181
7.4.2	New knowledge as a result of experiencing V2G charging	182
7.4.3	Effects of experience on the identified factors	183
7.4.4	Consumer acceptance of V2G charging	186
7.4.5	Comparison of results with literature	195
7.4.6	Outlook on wider V2G acceptance	196
7.5	Conclusions	197
7.6	Appendix A: Operation of the V2G setup	200
8	CONCLUSIONS	207
8.1	Answers to the research questions	207
8.2	Connection with recent developments	209
8.3	Recommendations and Outlook	211
8.3.1	Recommendations	211
8.3.2	Policy outlook related to solar car parks in the Netherlands	212
8.4	Future research	213
	ACKNOWLEDGMENTS	217
	CURRICULUM VITÆ	221
	LIST OF PUBLICATIONS	223

SUMMARY

The electricity grid in the Netherlands is currently unable to provide sufficient capacity for both the integration of new renewable electricity powerplants as well as for the integration of new electricity demands like electric vehicle charging. Symptoms of this scarcity of capacity, also seen in other countries undergoing an energy transition, are observed in various forms.

On the generation side, newly planned solar photovoltaic projects at both commercial and residential scales are increasingly being denied permission to connect to the grid or face long delays for grid reinforcement before they are connected. Since 2020, new utility-scale solar Photovoltaic (PV) installations were provided a maximum of 70% grid connection capacity relative to the solar installed capacity. In 2022, this permitted grid connection capacity has been further lowered to 50% for new projects larger than 1 MWp.

On the demand side, recent mapping studies by the Dutch grid operators show that a majority of the country faces structural congestion in the distribution and transmission grids. The Dutch ambition, as stated in the Regional Energy Strategy (RES), is to integrate 12 GWp of additional solar installed capacity to the existing 14 GWp by 2030. Also by 2030, the total number of Electric Vehicles (EVs) in the Netherlands is expected to increase from about 390,000 (4.4% of the total Dutch passenger vehicle fleet) today to about 1 million (10%), increasing the peak electricity demand.

The scarcity of capacity in the electricity grid to integrate both low carbon solar generation and electric vehicle charging presents an obstacle to the realisation of both short and long term emissions targets. Even though significant grid expansion is already planned and commissioned, this scarcity of capacity is expected to be a characteristic feature of the electricity grid over the coming decades. This thesis aims to investigate how the coupling of solar carparks and EV charging can enable their integration in a grid with scarce capacity while lowering operational carbon emissions.

Two configurations of solar carparks for EV charging are analysed, with the aim of reducing the grid capacity needed:

Chapter 3 analyses the first configuration: a solar carpark for charging EVs at a workplace in the Netherlands where demand peaks are caused by the simultaneous charging of EVs. The inclusion of EV demand forecasting within the scheduled charging reduces annual peak EV charging power by 36-39% relative to immediate charging. These reductions in peak demand enable a more effective use of the available power capacity (now mandated to 50% of solar installed capacity) as well as increase the utilisation of generated solar energy by reducing the need for solar curtailment.

Chapter 4 investigates the second configuration: an off-grid solar carpark for EV charging at a long term (>24 hours) parking lot in a Dutch airport. Offgrid solar charging would enable rapid planning of charging facilities for EVs, removing the uncertainty, delays and costs associated with a grid connection. However, these benefits come with a trade-off: not all vehicles are fully charged at the time of departure. With immediate charging, 20% of EVs over the year leave with a state-of-charge lower than 60% and 3% of EVs leave with a state-of-charge lower than 40%. The adequacy of fleet-level charging is lowest during the low irradiance month of December, during which 63% of vehicles leave with a state-of-charge lower than 60% and 11% of vehicles leave with a state-of-charge lower than 40%. Prioritising the charging of plugged-in vehicles with the lowest state-of-charge ensures that no vehicles leave with a state-of-charge lower than 40% over the entire year, even in the low irradiance winter months. Increasing the minimum duration of parking reduces the fraction of vehicles leaving with state-of-charge below 60% by about 2% per day.

The consequences of scheduled charging on greenhouse gas emissions are investigated in **Chapters 5** and **6**:

Chapter 5 analyses a recently constructed solar carpark located in Dronten, the Netherlands, which includes a solar array, a nickel metal hydride battery and charge points for electric vehicle charging. The aim of the study is to quantify the magnitude of offset carbon emissions per year by the solar carport, and the contribution of battery storage to this offset. The prevalent practice of using the annual average carbon intensity is found to be unsuitable for estimating the annual offset carbon emissions since it does not account for the intra-day patterns of solar production, EV charging and battery cycling. To overcome this, we propose a novel method to calculate the annual offset carbon emissions, making use of the hourly average and hourly marginal carbon intensity. The choice of approach is found to make a difference to the calculated values of the annual offset emissions of the solar carpark. The use of hourly average carbon intensity, which takes into account variation in production, generation and storage, leads to a higher calculated value of annual offset carbon emissions by about 7% relative to a method using the annual average carbon intensity. The use of the hourly marginal carbon intensity to calculate the annual offset carbon emissions suggests that solar carparks have about a 55% higher incremental effect on the carbon intensity associated with the new load of EV charging than what is conventionally calculated. When comparing the annual offset carbon emissions from the solar carpark with and without a battery, we find that the use of the battery has a negligible effect on the annual carbon offset by the system. This result is found to be robust across all the methods of calculation. We therefore conclude that the use of batteries in solar carparks have a low contribution to the total carbon offset by the solar carport.

Chapter 6 investigates the effect of price-based scheduling of EV charging on the carbon intensity of the electricity used by a scheduled fleet of EVs. Real data of over

55,000 home charging sessions collected from 1031 charge points in the Netherlands is analysed. A simulation is made with a commercial smart charging algorithm to create a scheduled charging profile ex post from the EV charging data set. The profile results in an average price reduction of 25% for the overall fleet relative to the costs for unscheduled charging of the fleet over the same period. The time dependent hourly carbon intensity of electricity consumed in the Dutch low voltage grid in 2018 is used to find the impact of price-based scheduling on the mean carbon intensity of electricity used by the fleet. A small decrease of 1.2% in carbon intensity used by the entire EV fleet is observed over the year. Although price optimisation has large effects on the carbon intensity in individual sessions, the effect is found to balance out over the large number of sessions in the year.

Chapter 7 investigates the factors affecting the consumer acceptance of Vehicle-to-Grid (V2G) charging, which remains an insufficiently investigated barrier for the use of the full potential of EVs in demand response and storage. The research work comprises two stages of semi-structured interviews: the first with EV drivers who have never experienced V2G charging, and the second with EV drivers who experienced V2G charging. The participants in the second stage are given access to a V2G-compatible Nissan LEAF and the V2G charging facilities set up in a living lab on the University campus for at least a week each, after which they are interviewed. Clear communication of the battery impacts, financial compensation and operational control are all found to foster acceptance and were, in many cases, necessary conditions for acceptance. The main barriers for acceptance found are range anxiety in various forms, concerns about the effects of V2G charging on the EV battery and the perceived loss of freedom associated with private vehicles. A majority of participants interviewed from both groups are found to accept or conditionally accept V2G charging. This suggests that the use of EVs for demand side storage in addition to demand response is already acceptable to a subset of current EV drivers. The study also clarifies the conditions under which V2G charging would be more acceptable to a broader group of EV users.

The results obtained in this thesis show that the coupling of solar photovoltaics and EV charging enables the integration of both in a grid with scarce capacity. We therefore recommend that solar carparks for EV charging be more widely implemented at workplaces and at longterm (>24 hour) parking lots, though without stationary batteries.

SAMENVATTING

Het elektriciteitsnetwerk in Nederland is momenteel niet in staat voldoende capaciteit te leveren voor zowel de integratie van nieuwe hernieuwbare energiecentrales als de integratie van nieuwe elektriciteitsvragen, zoals het opladen van elektrische voertuigen (EV). Dit capaciteitstekort uit zich via verschillende symptomen. Ditzelfde geldt voor andere landen die bezig zijn met een energietransitie.

Steeds meer en steeds vaker krijgen nieuw geplande commerciële en residentiële zonnestroominstallaties geen toestemming om aan te sluiten op het elektriciteitsnetwerk of zij moeten lang wachten op netverzwaring voordat zij kunnen worden aangesloten. Sinds 2020 kregen nieuwe grootschalige zonnestroominstallaties maximaal 70% van de aansluitcapaciteit in verhouding tot de op zonne-energie geïnstalleerde capaciteit. In 2022 is deze toegestane aansluitcapaciteit verder verlaagd tot 50% voor nieuwe projecten groter dan 1 MWp.

Qua vraag laten recente overzichtsstudies van de Nederlandse netbeheerders zien dat een meerderheid van de landen te maken heeft met structurele congestie in de laag- en hoogspanningsnet. De ambitie van Nederland is, zoals vermeld in de Regionale Energie Strategie (RES), om voor 2030 12 GWp extra geïnstalleerde zonnecapaciteit in de bestaande 14 GWp te integreren. Er wordt tevens verwacht dat tegen 2030 het totaal aantal elektrische voertuigen in Nederland stijgt van ongeveer 390.000 (4,4% van de totale Nederlandse personenvloot) nu tot ongeveer 1 miljoen (10%), hetgeen de piekvraag naar elektriciteit verhoogt.

Het capaciteitstekort op het elektriciteitsnet om zowel zonne-energieopwekking met lage CO₂-uitstoot en het opladen van elektrische voertuigen te integreren, vormt een belemmering voor het realiseren van de emissiedoelen op zowel de korte als de lange termijn. Hoewel er al een aanzienlijke uitbreiding van het netwerk is gepland en in opdracht genomen, wordt verwacht dat dit capaciteitstekort de komende decennia een karakteristiek kenmerk van het elektriciteitsnet zal zijn. Deze thesis wil onderzoeken hoe het koppelen van solar carports en het opladen van EV de integratie hiervan in een netwerk met een lage capaciteit mogelijk kan maken en tegelijkertijd de operationele CO₂-uitstoot verlaagt.

Er worden twee configuraties van solar carports voor het opladen van EV geanalyseerd, met het doel de benodigde netwerkcapaciteit te verminderen: **Hoofdstuk 3** analyseert de eerste configuratie: een solar carport voor het opladen van EV's op een werkplek in Nederland waar verbruikspieken worden veroorzaakt door het gelijktijdig opladen van EV's. De integratie van het voorspellen van de vraag van EV binnen het scheduling-probleem vermindert de jaarlijkse piek in het opladen van EV met 36-39% in

vergelijking met het direct opladen. Door de piekvraag te verlagen, kan effectiever gebruik worden gemaakt van de beschikbare energiec capaciteit (nu verplicht 50% van de geïnstalleerde zonne-energiecapaciteit) en het verlagen van het gebruik van opgewekte zonne-energie door het verminderen van de behoefte aan solar curtailment.

In **hoofdstuk 4** wordt de tweede configuratie onderzocht: een off-grid solar carpark voor het opladen van EV op een parkeerplaats voor lang parkeren (>24 uur) bij een Nederlandse luchthaven. Dankzij off-grid opladen met zonne-energie kunnen oplaadfaciliteiten voor EV's snel gepland worden, wat onzekerheid, vertragingen en kosten wegneemt die samenhangen met een netaansluiting. Deze voordelen hebben echter ook een nadeel: niet alle voertuigen zijn bij vertrek volledig opgeladen. Met direct opladen vertrekt 20% van de EV's in de loop van het jaar met een ladingstoestand van minder dan 60% en 3% van de EV's met een ladingstoestand lager dan 40%. De doelmatigheid van het opladen op vlootniveau is het laagst tijdens de maand december vanwege de lage zonnestraling. In deze maand vertrekt 63% van de voertuigen met een ladingstoestand lager dan 60% en 11% van de voertuigen met een ladingstoestand lager dan 40%. Door het opladen van aangesloten voertuigen met de laagste ladingstoestand te prioriteren, vertrekken er het hele jaar geen voertuigen met een ladingstoestand onder de 40%, zelfs niet in de wintermaanden wanneer de zonnestraling laag is. Door de minimum parkeerduur te verhogen, wordt het gedeelte auto's dat vertrekt met een ladingstoestand onder de 60% met ongeveer 2% per dag verminderd.

De gevolgen van het gepland opladen op de uitstoot van broeikasgassen worden onderzocht in **hoofdstuk 5** en **6**:

In **hoofdstuk 5** wordt een recent aangelegd solar carpark in Dronten onderzocht dat bestaat uit een zonnepaneelopstelling, een nikkel-metaal hydridebatterij en oplaadpunten voor elektrische voertuigen. Het doel van het onderzoek is de omvang van de jaarlijkse offset CO₂-uitstoot door de solar carport te kwantificeren, en de bijdrage van batterijopslag aan deze offset. De heersende praktijk van het gebruiken van de jaarlijkse gemiddelde koolstofintensiteit is ongeschikt bevonden voor het inschatten van de jaarlijkse offset CO₂-uitstoot, aangezien deze geen rekening houdt met de intra-day patronen van de zonneproductie, het opladen van EV en de laadcyclus. Om dit te verhelpen, stellen wij een nieuwe methode voor om de jaarlijkse offset CO₂-uitstoot te berekenen, gebruikmakend van het uurgemiddelde en de marginale koolstofintensiteit per uur. De keuze van aanpak kan een verschil maken voor de berekende waarden van de jaarlijkse offset uitstoot van het solar carpark. Door gebruik te maken van de gemiddelde koolstofintensiteit per uur, die rekening houdt met variatie in productie, opwekking en opslag, leidt dit tot een hogere berekende waarde van de jaarlijkse offset koolstofuitstoot van ongeveer 7% in vergelijking met een methode die gebruikmaakt van de jaarlijkse gemiddelde koolstofintensiteit. Het gebruik van de marginale koolstofintensiteit per uur voor het berekenen van de jaarlijkse offset koolstofuitstoot suggereert dat solar carports ongeveer 55% hoger toenemend effect hebben op de koolstofintensiteit die in verband

gebracht wordt met de nieuwe vraag van het opladen van EV's dan wat gewoonlijk wordt berekend. Bij het vergelijken van de jaarlijkse offset CO₂-uitstoot van het solar carpark met en zonder batterij, zien we dat het gebruik van de batterij een verwaarloosbaar effect heeft op de jaarlijkse koolstofcompensatie van het systeem. Dit resultaat is robuust voor alle berekeningsmethoden. Onze conclusie is daarom dat het gebruik van batterijen in solar carports een lage bijdrage levert aan de totale koolstofcompensatie van de solar carport.

In **hoofdstuk 6** wordt onderzocht wat het effect is van op prijzen gebaseerde planning van het opladen van EV's op de koolstofintensiteit van de elektriciteit die wordt gebruikt door een scheduled vloot EV's. Echte data van meer dan 55.000 thuislaadsessies die van 1031 oplaadpunten in Nederland zijn verzameld, wordt geanalyseerd. Er wordt een simulatie gemaakt met een commercieel slim laad algoritme om een scheduled oplaadprofiel ex post te maken van de oplaad dataset van de EV. Het profiel leidt tot een gemiddelde prijsverlaging van 25% voor de gehele vloot in vergelijking met de kosten voor ongepland opladen van de vloot gedurende dezelfde periode. De tijdsafhankelijke koolstofintensiteit per uur van de elektriciteit die in 2018 in het Nederlandse laagspanningsnet werd gebruikt, wordt gebruikt om de impact te vinden van op prijzen gebaseerde planning op de gemiddelde koolstofintensiteit van de elektriciteit die door de vloot wordt gebruikt. Er wordt gedurende het jaar een lichte daling gezien van 1,2% in koolstofintensiteit dat is gebruikt door de gehele vloot EV's. Hoewel prijs optimalisatie grote invloed heeft op de koolstofintensiteit in individuele sessies, is aangetoond dat het effect gedurende het grote aantal sessies per jaar in balans blijft.

In **hoofdstuk 7** worden de factoren onderzocht die de consumentenacceptatie van vehicle-to-grid (V2G) opladen beïnvloeden. Dit blijft een onvoldoende onderzochte barrière voor het gebruik van het volledige potentieel van EV's in vraagrespon en opslag. Het onderzoek bestaat uit twee fases van semigestructureerde interviews: de eerste met EV-rijders die geen ervaring hebben met V2G-charging, en de tweede met EV-rijders die wel ervaring hebben met V2G-charging. De deelnemers aan de tweede fase krijgen een V2G-compatibele Nissan LEAF toegewezen. Verder krijgen zij toegang tot de V2G-laadfaciliteiten die in een living lab op de universiteitscampus zijn opgesteld voor minimaal een week, waarna zij worden geïnterviewd. Duidelijke communicatie over de impact op de batterij, financiële compensatie en operationele controle blijken allemaal de acceptatie te bevorderen en waren in veel gevallen de noodzakelijk voorwaarden voor acceptatie. Onder de belangrijkste belemmeringen voor acceptatie die worden genoemd vallen bezorgdheid in allerlei vormen, zorgen over de gevolgen van V2G-charging op de batterij van de EV en het vermeende verlies aan vrijheid die samenhangt met privévoertuigen. Een meerderheid van de geïnterviewde deelnemers uit beide groepen accepteert V2G-charging volledig of gedeeltelijk. Dit suggereert dat het gebruik van EV's op het gebied van opslag aan de vraagkant van het elektriciteitssysteem als aanvulling op de vraagrespon al acceptabel is voor een deel

van de huidige EV-bestuurders. Het onderzoek maakt ook duidelijk wat de voorwaarden zijn waardoor V2G-charging beter zou worden geaccepteerd door een groter aantal EV-gebruikers.

De in deze thesis verkregen resultaten laten zien dat door de koppeling van zonnestroominstallaties en het opladen van EV's beide geïntegreerd kunnen worden in een netwerk met een lage capaciteit. Wij adviseren daarom dat solar carparks voor het opladen van EV's breder worden geïmplementeerd op werkplekken en op parkeerplaatsen voor lang parkeren (>24 uur), maar dan zonder stationaire batterijen.

ACRONYMS

AC	Alternating Current.
ADMD	After-Diversity Maximum Demand.
BEV	Battery Electric Vehicle.
BMS	Battery Management System.
BoS	Balance-of-System.
CAIDI	Customer Average Interruption Duration Index.
CAIFI	Customer Average Interruption Frequency Index.
CAN	Controller Area Network.
CCS	Combined Charging System.
CEC	California Energy Commission.
CHAdEMO	CHArge de MOve.
CI	Carbon Intensity.
CPO	Charge Point Operator.
CR	Critical Ratio.
CSO	Charging Station Operator.
DAM	Day Ahead Market.
DC	Direct Current.
DSO	Distribution System Operator.
DUOATS	Direct Use of Observed Activity-Travel Schedule.
EMSP	Electric Mobility Service Provider.
ERCOT	Electric Reliability Council of Texas.
EU	European Union.
EV	Electric Vehicle.
EVSE	Electric Vehicle Supply Equipment.

FCEV	Fuel Cell Electric Vehicle.
FU	Functional Unit.
GCR	Ground Coverage Ratio.
GHG	Greenhouse Gas.
GWP	Global Warming Potential.
ICE	Internal Combustion Engine.
IEA	International Energy Agency.
IPCC	Intergovernmental Panel on Climate Change.
KAP	Knowledge-Attitude-Practice.
KiBaM	Kinetic Battery Model.
LCA	Life Cycle Analysis.
LCI	Life Cycle Inventory.
LCoE	Levelised Cost of Electricity.
LPP	Linear Programming Problem.
MLD	Mixed Logical Dynamics.
MPC	Model Predictive Control.
MPPT	Maximum Power Point Tracking.
NEDC	New European Driving Cycles.
NL	Netherlands.
OEM	Original Equipment Manufacturer.
OLTC	On Load Tap Changers.
PBL	Planbureau voor de Leefomgeving.
PERC	Passivated Emitter and Rear Cell.
PEV	Plug-in Electric Vehicle.

PHEV	Plug-in Hybrid Electric Vehicle.
PV	Photovoltaic.
PVGIS	Photovoltaic Geographical Information System.
PWM	Pulse Width Modulation.
RES	Regional Energy Strategy.
SAM	System Advisor Model.
SDE	Stimulerend Duurzame Energieproductie.
SoC	State of Charge.
STC	Standard Test Conditions.
TAM	Technology Acceptance Model.
TMY	Typical Meteorological Year.
TPB	Theory of Planned Behaviour.
TRA	Theory of Reasoned Action.
TSO	Transmission System Operator.
TTW	Tank-to-Wheel.
UTAUT	Unified Theory of Acceptance and Use of Technology.
V2B	Vehicle-to-Building.
V2G	Vehicle-to-Grid.
V2H	Vehicle-to-Home.
V2L	Vehicle-to-Load.
V2X	Vehicle-to-X.
WLTP	Worldwide harmonised Light-vehicle Test Procedure.
WTT	Well-to-Tank.
ZLEV	Zero- and Low-Emission Vehicle.

INTRODUCTION

1.1 LIMITED GRID CAPACITY: CONSEQUENCES FOR SOLAR ENERGY INTEGRATION

In 2019, the Dutch Minister for Economic Affairs and Climate, Eric Wiebes, wrote a letter to the Dutch parliament. The letter was titled “*Consequences of the lack of grid capacity for sustainable energy projects*” [1]. As outlined in the letter, the Dutch Distribution System Operators (DSOs) were preparing for the large-scale reinforcement of the national electricity grid to meet the the demand for the transportation of electricity.

A large part of this demand was for the integration of the growing number of sustainable energy projects, in particular, solar and wind. However, the demand for transport capacity was growing faster than the DSOs were able to reinforce the grid. As reported by some DSOs, the increase in grid capacity required in the previous two years in some regions was found to be equivalent to that which would otherwise have been needed over 30 years. Almost all the the Dutch provinces were either experiencing or soon expected to experience shortages in grid capacity.

Fig. 1.1 shows an overview of the available capacity for the feed in of electricity in the Dutch grid in 2021. The available capacity in the high voltage grid, as published by the Dutch Transmission System Operator (TSO), TenneT, is shown in Fig. 1.1(a). Each data point represents a switching station for connection to feed electricity into the high voltage (110 kV or 150 kV) grid. Similarly, Fig. 1.1(b) shows the available capacity for large electricity users to deliver electricity back to the grid, as published by Netbeheer Nederland, the consortium of Dutch DSOs.

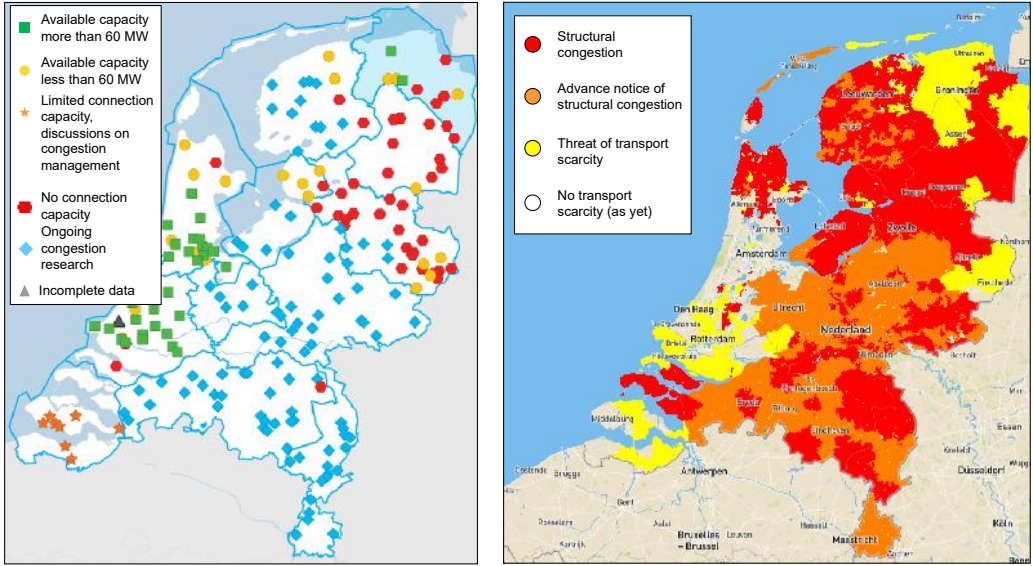

(a) Available feed-in capacity in the Dutch high voltage grid (Source: TenneT [2])

(b) Available feed-in capacity in the Dutch low voltage grid (Source: Netbeheer Nederland [3])

Figure 1.1: Available capacity for feed-in of electricity in the Dutch grid (Date: 16th June 2022)

As seen in Fig. 1.1(a), relatively few locations in the country are available for the connection of 60 MW of generation capacity to the high voltage grid. This scarcity of capacity is not limited to the high voltage grid. Fig. 1.1(b) shows that there is an almost nationwide shortage of capacity for transporting electricity generated in the low voltage grid. In the provinces of Limburg and North Brabant, to the south of the Netherlands, the lack of capacity in the high voltage grid has led to the restriction of all new grid connections as well as requests for higher capacity on existing connections [4].

The Netherlands Enterprise Agency (RVO) [5] reports that the impacts of scarcity in grid capacity are already being felt among small and large solar producers in various ways:

- About 15% of SDE+ supported solar energy projects¹ since 2017 that failed to be realised cited grid capacity as a responsible factor, a fraction that has been growing in recent years. In some cases, solar energy projects did not receive permission to connect by the DSO due to scarcity of capacity. In others, permission was provided, but at the point of realisation, the required capacity was no longer available.

¹ In the Netherlands, the Stimulerend Duurzame Energieproductie (SDE) is the central governmental subsidy scheme stimulating sustainable energy generation projects. The original SDE was subsequently replaced by the SDE+ and SDE++ schemes.

- The business case for large solar energy projects is affected by the additional costs associated with reinforcing the grid capacity. Further, the long lead times for providing capacity greatly extend the project duration and therefore costs for solar parks.
- Small producers suffer temporary interruptions in solar generation due to voltage issues, affecting their revenue through the feed-in of electricity. They also face long delivery times for a request for a new or modified grid connection.

In order to limit global temperature rise to 1.5° C, the target stated in the Paris Climate Agreement [6], there is a need to transition to low-carbon sources of electricity generation such as solar photovoltaics. The Dutch target for solar energy is the integration of a total of 26 GWp of installed solar capacity in the Dutch grid by 2030², almost doubling the installed solar capacity in 2021³. The limited available grid capacity restricts the integration of newly built solar projects and therefore presents a threat to the realisation of this target.

1.2 LIMITED GRID CAPACITY: CONSEQUENCES FOR ELECTRIC VEHICLE INTEGRATION

The energy transition also includes the drive towards decarbonisation and electrification of passenger mobility. Among the most important policies in the EU are

- the EU-wide target of 95 gCO_2/km for the average emissions of passenger cars⁴ which are registered from 2021 [12].
- Strengthening of these fleetwide restrictions in 2025 and 2030, with only Zero- and Low-Emission Vehicles (ZLEVs)⁵ sales permitted after 2035 as part of the “Fit for 55” package to achieve the EU 2030 greenhouse gas emission reduction target of at least 55% compared to 1990 levels [14].

² The National Climate and Energy Outlook, whose values are used here, projects 26 GWp of installed solar capacity [7, p. 166] in 2030 delivering 84.8 PJ (23.5 TWh) of final energy as electricity [7, p. 96]. The Dutch Climate Agreement aims to deliver 35 TWh of energy from renewables on land by 2030, making no distinction between sources [8, p. 33]. The RES, which builds upon the Climate Agreement, indicates that 12 TWh of this 35 TWh will be contributed by utility scale solar PV on roofs while 5 TWh will be produced by groundmounted utility scale installations. An additional 7 TWh, aside from the 35 TWh, is expected to be sourced from domestic scale solar installations, leading to a total of 24 TWh produced by solar photovoltaics [9], very close to the Climate and Energy Outlook projection.

³ As of 2021, the installed solar capacity in the Dutch grid was 14.25 GWp [10]

⁴ For reference, the average emissions for new passenger vehicles registered in 2020 was 107.7 gCO_2/km based on the New European Driving Cycles (NEDC) and 130.3 gCO_2/km based on the Worldwide harmonised Light-vehicle Test Procedure (WLTP) [11] which has been in use in the EU since 2017.

⁵ ZLEVs are defined as passenger vehicles with tailpipe emissions lower than 50 gCO_2/km [13]

EVs have zero tailpipe emissions⁶ and are seen as a promising ZLEV technology for passenger vehicles by both users and policy makers. As an example, from the year 2030 onward, the city of Amsterdam will permit only emissions-free transport within the city limits [15]. This will cover not just passenger vehicles but also heavier vehicles like trucks and buses. Also from 2030, only the sale of emissions-free vehicles will be permitted in the Netherlands [8]. As such, a large growth in the number of electric vehicles is expected over the next decades [16].

The electrification of the passenger vehicle fleet necessarily involves the development of charging infrastructure to power these vehicles. EV charging profiles depend on the mobility patterns of EV drivers. The EV driving demographic tends to be geographically clustered in terms of residence, employment and other common parking locations, where vehicles spend long durations of time charging. EV charging is thus characterised by simultaneity and colocation. In simpler terms, there is a tendency for EV charging to occur at the same place at the same time.

This behaviour can be observed at locations where EV charging takes place. Fig. 1.2 shows the normalised distribution of arrival times (i.e. the times of starting of charging sessions), for the three most important charging locations: in private residential areas, in workplaces and in public locations, as measured over several years in the Netherlands.

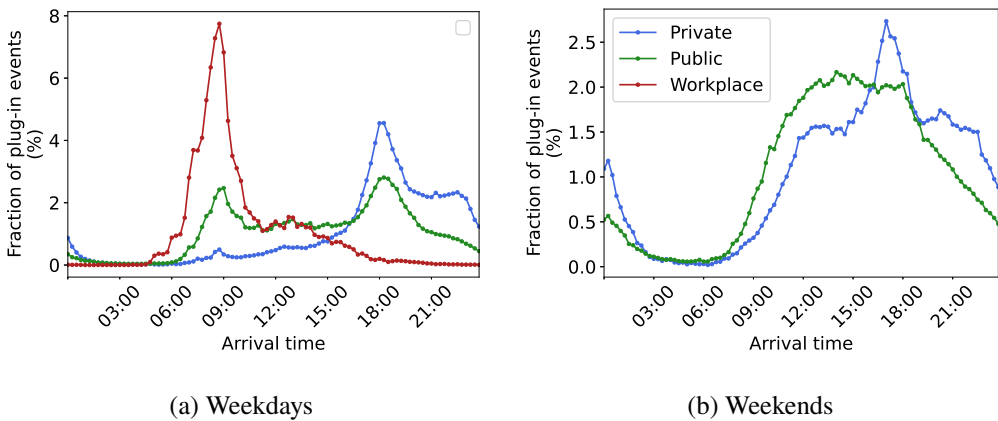

Figure 1.2: Normalised distribution of arrival times i.e. the starting of charging sessions for private residences, workplaces and public locations based on data measured in the Netherlands between 2018 and 2020 (Source: ElaadNL [17])

Fig. 1.2(a) shows high morning peaks in the number of arrivals at workplaces, evening peaks at private residences and both morning and evening peaks at public locations on weekdays. Similarly, Fig. 1.2(b) shows the afternoon and evening peaks in power demand

⁶ For further discussion on emissions associated with EVs over their lifecycle, see Chapter 5.

observed at private residences and public charge points on weekends, though they are lower in magnitude than those observed on weekdays.

When large EV fleets charge in an uncontrolled manner, high peaks in power demand are observed in the charging profiles. The capacity of the grid to transport electricity to meet peak power demand due to EV charging is constrained at various voltage levels. At the low voltage level in the distribution grid, the consequences of this lack of capacity are observed through the impacts on distribution level grid assets and distribution level power quality. These are well studied in literature and an overview of earlier studies is presented in Table 1.1.

Table 1.1: Impacts of uncontrolled scaled EV charging with insufficient grid capacity

Impact category	Impact	Source
Impacts on grid assets	Low voltage cable overloading	[18–21]
	Low voltage transformer overloading	[18–24]
Impacts on power quality	Voltage drops	[18, 20, 22–27]

These symptoms, already observed in the distribution level grid, are early indicators of the broader inability of grid infrastructure to meet peak load demand. As an example, recent investigations by the Dutch DSO, Liander, reveal the scarcity of transport capacity to meet peak loads in the electricity grid in and around the city of Amsterdam [28]. The results of these investigations are visualised in Fig. 1.3 where Fig. 1.3(a) maps out the status of grid congestion in the various zones in the city, while Fig. 1.3(b) shows the status of congestion in the Dutch province of North Holland, where Amsterdam is located.

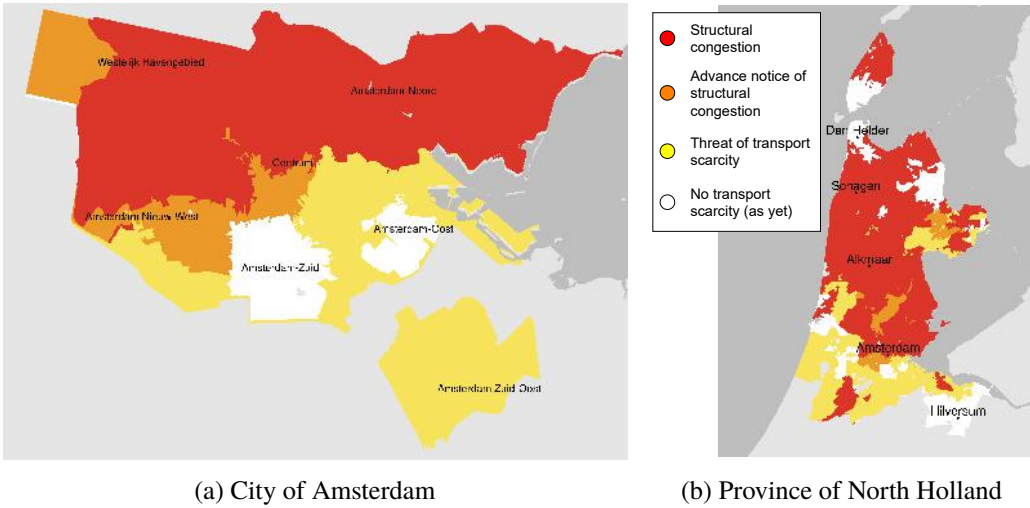

Figure 1.3: Available grid capacity to meet electricity demand in Amsterdam and the surrounding regions (Source: Liander [28] 16th June 2022)

Fig. 1.3(a) reveals that a significant portion of the city either faces structural congestion in the electricity grid or is in imminent danger of facing scarcity of capacity to meet demand. The province of North Holland faces similar issues, with significant zones in the north of the province facing structural congestion. For the identified bottlenecks in transport capacity, the structural nature of the congestion means that DSOs do not see congestion management as a viable solution [29].

In order to limit net transport emissions, ambitious targets have been set for the electrification of the passenger vehicle fleet in Amsterdam, the Netherlands and the EU. The limited capacity of the electricity grid to accommodate the peak power demands of EV charging presents an immediate obstacle to the realisation of these targets.

1.3 SOLAR CARPARKS FOR EV CHARGING

At solar carparks, solar PV arrays are mounted on load bearing structures, known as solar carports. They are often constructed at parking lots adjacent to large consumers of electricity, such as large employment centres, public institutions and commercial centres. As an example, Fig. 1.4 shows a solar carpark at the parking lot of the Dutch Municipality of Dronten. It was developed, installed and monitored as part of the Powerparking project, to which this research contributed.



Figure 1.4: Solar carports for EV charging constructed at the municipality building, Dronten, the Netherlands

The electricity generated in solar carports could be used to meet the large existing loads at locations adjacent to these parking lots. This electricity could also be used to meet the growing demand for EV charging at these parking lots. By colocating generation and demand, both the need for the transport of electricity as well as the corresponding need for capacity in the grid could be reduced.

Thus, solar carports present an opportunity for the integration of both distributed generation through solar PV as well as EV charging in a grid with limited capacity.

1.4 RESEARCH QUESTIONS AND THESIS STRUCTURE

The main research question of this thesis is *‘To what extent does the coupling of solar carports and electric vehicle charging reduce the impact on the grid and on CO₂ emissions?’*

To answer this, the following sub-questions are formulated:

1. Which configurations of solar carpark systems for EV charging reduce the grid capacity required and CO₂ emissions associated with charging?

2. To what extent does controlled charging reduce the grid capacity required and CO_2 emissions associated with EV charging?
3. How willing are EV users to accommodate controlled charging through V2G and under what conditions?

These questions are addressed over the rest of this thesis, as described below.

Chapter 2 presents a review of literature that provides background for the remaining chapters. It describes the technologies under consideration and the actors involved in the EV charging ecosystem.

Chapters 3 and **4** address the first two sub-questions. The operation of two configurations of solar car parks for EV charging are analysed and the extent of grid capacity reduction in each configuration is estimated. **Chapter 3** investigates a solar car park for EV charging at a large employment centre in the Netherlands and **Chapter 4** investigates solar car parks for EV charging at long term parking lots.

Chapters 5 and **6** focus on the second research question. **Chapter 5** analyses the carbon offset enabled through solar car parks for EV charging and the effects of battery storage on the annual emissions offset. **Chapter 6** investigates the effect of price-based scheduled charging of larger EV fleets in the Dutch grid on the mean carbon intensity of electricity used to charge the fleet.

Chapter 7 aims to answer the third sub-question, investigating the consumer acceptance of V2G charging at a solar car park.

Finally, **Chapter 8** presents the main conclusions of this thesis and the relevance of the results. It also includes reflections on the development of the field over the course of this study and an outlook for future research.

1.5 GUIDE FOR READERS

This thesis is intended to be read as a complete and ordered text. However, it is a compilation of chapters, many of which are based on published articles. Chapters 3-7 are written as self-contained and independent works, not requiring the prior reading of previous chapters. Each of these chapters also includes its own introduction, literature review and bibliography. As such, the selective reader can go directly to the chapter of interest without any loss of continuity.

This thesis is written for academic researchers working on EV charging and integration, solar PV system design and analysis, EV emissions studies and consumer acceptance of

smart charging. It is also expected to be of considerable interest to engineers in the solar and EV sectors, infrastructure project designers and planners, business developers in the field of EV charging, grid operators, electric mobility service providers and policy makers guiding the fast developing future of energy systems and electric mobility.

REFERENCES

-
- [1] Wiebes, E. *Kamerbrief over gevolgen van het gebrek aan netcapaciteit voor duurzame elektriciteitsprojecten*. Letter. 2019. URL: <https://www.rijksoverheid.nl/documenten/kamerstukken/2019/06/28/kamerbrief-over-gevolgen-van-het-gebrek-aan-netcapaciteit-voor-duurzame-elektriciteitsprojecten> (visited on 10/18/2021).
- [2] TenneT, *Netcapaciteitskaart*. Nederlandse Markt. 2022. URL: <https://www.tennet.eu/nl/elektriciteitsmarkt/nederlandse-markt/netcapaciteitskaart/>.
- [3] Netbeheer Nederland, *Capaciteitskaart invoeding elektriciteitsnet*. 2022. URL: <https://capaciteitskaart.netbeheernederland.nl>.
- [4] TenneT, *Voorlopige stop voor nieuwe grootverbruikers van elektriciteit in Noord-Brabant en Limburg*. 2022. URL: <https://www.tennet.eu/nl/tinyurl-storage/nieuws/voorlopige-stop-voor-nieuwe-grootverbruikers-van-elektriciteit-in-noord-brabant-en-limburg/>.
- [5] Netherlands Enterprise Agency (RVO), *Monitor Zon-PV 2021 in Nederland*. RVO-183-2021-RP-DUZA. The Hague, the Netherlands, 2021. URL: <https://www.rijksoverheid.nl/documenten/rapporten/2021/09/23/monitor-zon-pv-in-nederland>.
- [6] United Nations, *Paris Climate Agreement*. 2015. URL: https://unfccc.int/sites/default/files/english_paris_agreement.pdf (visited on 06/21/2021).
- [7] Hammingh, P., Menkveld, M., Daniëls, B., Koutstaal, P., Schure, K., Hekkenberg, M., *Klimaat- en Energieverkenning 2020*. The Hague, the Netherlands: Netherlands Environmental Assessment Agency (Planbureau voor de Leefomgeving), 2020. URL: <https://www.pbl.nl/sites/default/files/downloads/pbl-2020-klimaat-en-energieverkenning2020-3995.pdf>.
- [8] Rijksoverheid, *Climate Agreement*. The Hague, the Netherlands, 2019. URL: <https://www.government.nl/documents/reports/2019/06/28/climate-agreement>.
- [9] Nederlands Vereniging Duurzame Energie, *Hernieuwbare Energiebronnen op Land in de Regionale Energiestrategie (RES)*. 2020. URL: <https://www.nvde.nl/wp-content/uploads/2020/02/NVDE-Hernieuwbare-energiebronnen-op-land-in-de-Regionale-Energiestrategie-feb2020.pdf>.
- [10] Lebedys, A., Akande, D., Coënt, N., Elhassan, N., Escamilla, G., Arkhipova, I., Whiteman, A., *Renewable Energy Capacity Statistics 2022*. ISBN: 978-92-9260-428-8. Abu Dhabi: International Renewable Energy Agency, 2022. URL: https://irena.org/-/media/Files/IRENA/Agency/Publication/2022/Apr/IRENA_RE_Capacity_Statistics_2022.pdf.
- [11] European Environment Agency, *Monitoring of CO2 emissions from passenger cars*. CO2 emissions from new passenger cars registered in EU27, UK, Iceland (from 2018) and Norway (from 2019) – Regulation (EU) 2019/631. 2021. URL: <http://co2cars.apps.eea.europa.eu/>.
- [12] The European Parliament and the Council of the European Union, *Regulation (EU) 2019/631 of the European Parliament and of the Council of 17 April 2019 setting CO2 emission performance standards for new passenger cars and for new light commercial vehicles, and repealing Regulations (EC) No 443/2009 and (EU) No 510/2011*. 2021. URL: <https://eur-lex.europa.eu/legal-content/EN/TXT/PDF/?uri=CELEX:02019R0631-20211202&from=EN> (visited on 02/18/2022).
- [13] The European Parliament and the Council of the European Union, *Regulation (EU) 2019/631 of the European Parliament and of the Council of 17 April 2019 - setting CO2 emission performance standards for new passenger cars and for new light commercial vehicles, and repealing Regulations (EC) No 443 / 2009 and (EU) No 510 / 2011*. 2019. URL: <https://eur-lex.europa.eu/legal-content/EN/TXT/PDF/?uri=CELEX:32019R0631&from=EN>.

- [14] The European Parliament and the Council of the European Union, *Proposal for a Regulation of the European Parliament and of the Council amending Regulation (EU) 2019/631 as regards strengthening the CO₂ emission performance standards for new passenger cars and new light commercial vehicles in line with the Union's increased climate ambition*. 2021. URL: https://ec.europa.eu/info/sites/default/files/amendment-regulation-co2-emission-standards-cars-vans-with-annexes_en.pdf.
- [15] Air Quality Team, *Amsterdam Clean Air Action Plan*. Amsterdam, the Netherlands: Municipality of Amsterdam, 2019. URL: <https://www.amsterdam.nl/en/policy/sustainability/clean-air/>.
- [16] Bibra, E. M., Connelly, E., Gorner, M., Lowans, C., Paoli, L., Tattini, J., Teter, J., *Global EV Outlook 2021*. Paris, France: International Energy Agency (IEA), 2021. URL: <https://www.iea.org/reports/global-ev-outlook-2021>.
- [17] ElaadNL, *Open Datasets for Electric Mobility Research*. 2020. URL: https://platform.elaad.io/analyses/ElaadNL_opendata.php (visited on 07/02/2021).
- [18] Verzijlbergh, R. A., Grond, M. O. W., Lukszo, Z., Slootweg, J. G., Ilic, M. D., "Network Impacts and Cost Savings of Controlled EV Charging." In: *IEEE Transactions on Smart Grid* 3.3 (2012), pp. 1203–1212. ISSN: 1949-3053, 1949-3061. DOI: 10.1109/TSG.2012.2190307. URL: <http://ieeexplore.ieee.org/document/6204213/> (visited on 02/20/2020).
- [19] Pieltain Fernández, L., Gomez San Roman, T., Cossent, R., Mateo Domingo, C., Frías, P., "Assessment of the Impact of Plug-in Electric Vehicles on Distribution Networks." In: *IEEE Transactions on Power Systems* 26.1 (2011). Conference Name: IEEE Transactions on Power Systems, pp. 206–213. ISSN: 1558-0679. DOI: 10.1109/TPWRS.2010.2049133.
- [20] Wargers, A., Kula, J., Ortiz de Obrigon, F., Rubio, D., *Smart charging: integrating a large widespread of electric cars in electricity distribution grids*. European Distribution System Operators for Smart Grids, 2018. URL: <https://www.edsoforsmartgrids.eu/wp-content/uploads/EDS0-paper-on-electro-mobility-2.pdf> (visited on 06/06/2019).
- [21] Iliceto, A. *ENTSO-E Position Paper on Electric Vehicle Integration into Power Grids*. Brussels, Belgium: ENTSO-E, 2021. URL: https://eepublicdownloads.entsoe.eu/clean-documents/Publications/Position%20papers%20and%20reports/210331-Electric_Vehicles_integration.pdf.
- [22] Gray, M. K., Morsi, W. G., "Power Quality Assessment in Distribution Systems Embedded With Plug-In Hybrid and Battery Electric Vehicles." In: *IEEE Transactions on Power Systems* 30.2 (2015). Conference Name: IEEE Transactions on Power Systems, pp. 663–671. ISSN: 1558-0679. DOI: 10.1109/TPWRS.2014.2332058.
- [23] Dubey, A., Santoso, S., "Electric Vehicle Charging on Residential Distribution Systems: Impacts and Mitigations." In: *IEEE Access* 3 (2015), pp. 1871–1893. ISSN: 2169-3536. DOI: 10.1109/ACCESS.2015.2476996.
- [24] Petit, M. *Electromobility in smart grids: State of the art and challenging issues*. Brussels, Belgium, 2019. URL: https://extranet.thinksmartgrids.fr/?get_group_doc=9/1599563637-GSGFReport-final.pdf.
- [25] Putrus, G. A., Suwanapingkarl, P., Johnston, D., Bentley, E. C., Narayana, M., "Impact of electric vehicles on power distribution networks." In: *2009 IEEE Vehicle Power and Propulsion Conference*. IEEE, 2009, pp. 827–831. URL: http://ieeexplore.ieee.org/xpls/abs_all.jsp?arnumber=5289760 (visited on 09/05/2016).
- [26] Clement-Nyns, K., Haesen, E., Driesen, J., "The Impact of Charging Plug-In Hybrid Electric Vehicles on a Residential Distribution Grid." In: *IEEE Transactions on Power Systems* 25.1 (2010), pp. 371–380. ISSN: 0885-8950. DOI: 10.1109/TPWRS.2009.2036481.
- [27] Math Bollen, Sarah Rönnberg, "Hosting Capacity of the Power Grid for Renewable Electricity Production and New Large Consumption Equipment." In: *Energies* 10.9 (2017), p. 1325. ISSN: 1996-1073. DOI: 10.3390/en10091325. URL: <http://www.mdpi.com/1996-1073/10/9/1325>.
- [28] Liander, *Transportcapaciteit in Amsterdam*. 2022. URL: <https://www.liander.nl/transportcapaciteit/amsterdam>.
- [29] Liander, *Update capaciteit elektriciteitsnet*. 2022. URL: <https://www.liander.nl/nieuws/2021/09/30/update-capaciteit-elektriciteitsnet>.

THEORY AND LITERATURE

2.1 INTRODUCTION

This chapter aims to provide an overview of the most important scientific literature upon which this thesis is based. The scope is relatively broad, since it includes studies which lie at the intersection between several research areas: solar PV system design, EV charging infrastructure planning, grid integration studies, emissions studies and technology acceptance evaluation.

A summarised overview of the theory and literature essential for the research chapters that follow is presented. Section 2.2 provides a brief overview of the current status of the most important technologies considered in this thesis: solar photovoltaics and EV supply equipment. Section 2.3 describes the most important actors involved in the EV charging ecosystem, as considered in this thesis. Section 2.4 describes in detail the limitations of the capacity in the electricity grid for the transport of electricity. Section 2.6 provides an overview of the historical development of solar car parks for electric vehicle charging.

2.2 OVERVIEW OF TECHNOLOGIES

The two main technologies considered throughout this thesis are solar photovoltaics and EV charging systems. Both technologies are developing rapidly in terms of technical performance, market share and economics, as a result of which currently valid facts and figures soon become outdated. An overview of these technologies is provided below.

2.2.1 SOLAR PHOTOVOLTAICS: CURRENT STATUS AND RECENT TRENDS

The solar PV sector has rapidly evolved in recent years, with several changes in technology, scale, economics and application. The general trends seen in the solar PV sector are

- The large growth in solar PV installed capacity globally [1]
- Steep drops in the cost of crystalline silicon modules and the Levelised Cost of Electricity (LCoE) from solar photovoltaics between 2010 and 2020 [2, 3]

- Increase in cell and module efficiencies and performance ratios [4]
- Reduction in silicon use per Wp, reduction in Greenhouse Gas (GHG) emissions per kWp installed and per kWh generated electricity produced and reduction in energy payback periods [2]
- Utility scale solar is growing as a share of installed capacity, which was earlier dominated by small scale solar installations [1]

The global solar market is rapidly expanding, with global installed capacity growing 16-fold between 2010 and 2020. During this period, the global weighted-average LCoE of newly commissioned utility-scale PV plants reduced by 85%. To a large extent, this was the result of steeply declining prices for crystalline silicon modules by between 89 and 95% in the last decade [3].

The increased market share of technologies like Passivated Emitter and Rear Cell (PERC) cells, half-cut cells and bifacial cells and modules have led to industry-wide increases in system-level conversion efficiencies and performance ratios. The more predominant use of diamond wire sawing for cutting silicon ingots has led to less wastage of silicon, thinner standardised wafers with higher surface finish and durability [5]. The higher yields and lower material consumption enabled through these advances, have led to both price reduction as well as reduced environmental impact.

The competitive prices, low emissions and modular nature of both small and large scale PV installations make it an attractive source of electricity generation. An overview of the most important current figures from the solar sector in the Netherlands, the EU and globally is provided in Table 2.1.

Due to its high market share, crystalline silicon has been used throughout this thesis, with module-level efficiencies in the range of 18-20%, reflecting representative values from commercial installations. Given the scales considered, typically in the range of a few hundred kWp installed capacity, centralised inverter configurations have been used, rather than module level converters, which are better suited for smaller installations.

Table 2.1: Overview of the current status of the solar PV sector in the Netherlands, the EU and globally

Parameter	Value		Unit	Status	Source
	NL	EU27 Global			
Annual PV Market	3.6	26	183	GW	2021 [6]/[7]/[7]
Cumulative installation	14.25	158.1	843.1	GWp	2021 [8]/[8]/[8]
PV electricity generation	8	145.9	855.7	TWh	2020 [9]/[7]/[7]
PV electricity fraction	7.8	5.3	3.2	%	2020 [9]/[7]/[7]
	NL	Global			
Weighted average total installed costs for newly commissioned utility scale PV projects	1068	883		USD/kWp	2020 [3]/[3]
Weighted average LCoE for newly commissioned utility scale PV projects	0.107	0.057		USD/kWh	2020 [3]/[3]

Continued on the next page

Table 2.1 – continued from the previous page

Parameter	Value	Unit	Status	Source
<i>Global</i>				
c-Si share of production	95	%	2020	[7]
c-Si representative module-level efficiency	20	%	2020	[4]
Utility scale inverters representative efficiency	<98	%	2020	[4]
Global Warming Potential per kWh (c-Si)	17-43	$g.CO_2eq./kWh_{AC}$	2021	[10]
Global Warming Potential per kWp (c-Si)	1010 to 1087	$kg.CO_2eq./kWp$	2021	[10]

2.2.2 SOLAR CARPORT STRUCTURES

A brief outline of the main types of carport structures (solar or otherwise) and their classification is provided in Table 2.2. The classification is based on the geometry of the supporting frame, the pitch (tilt) of the roof and the number of rows of parked vehicles, as described in [11].

T-frames tend to be convenient for parking since the supporting columns do not obstruct vehicles ingress and egress. However, the thick load-bearing cantilever beams as well as the deep foundations needed to support the structure tend to make these structures expensive. Inverter housing and charging infrastructure are typically located adjacent to the central columns.

V-frames require less materials and can, in certain cases, be constructed with footings rather than foundations. As such, they tend to be more cost-effective per parking space. However, V-frames tend to inhibit vehicle motion and occupy space, which is a problem, especially in longer rows of parking spaces. Inverter housing and charge points can be wall-mounted in the space between the V-columns or ground-mounted at a suitable location.

Portal frames tend to be used for larger parking lots, often with several parallel double-rows of vehicles. They often cover both the parking spaces as well as the aisles between them and have the highest ground coverage ratio¹. The additional materials required for covering the aisles tend to make the systems expensive. The roofs can be arches or beams, and can provide overhang beyond the columns if needed.

The pitch² of the roof of carports is typically determined by structural factors rather than solar energy yield optimisation, which is the main consideration in solar farms. Higher tilt angles³ lead to higher wind loads and need deeper foundations for the stability of the carport structure. Since the costs for deeper foundations generally outweigh the payback in terms of enhanced yield through tilt optimisation, there is a preference for lower tilts. In comparison with flat roofs, low tilts are beneficial for reducing soiling, less snow accumulation and improved rainwater drainage off the roof. As a result, tilts in the range of 10-15° are often chosen.



Monopitch roofs can improve yields by facing south in the northern hemisphere, and vice versa. However, since the azimuth of carports are generally dictated by parking geometries rather than yield optimisation, there is rarely a choice for designers to choose optimum azimuths.

1 The Ground Coverage Ratio (GCR) in a solar photovoltaic system is the ratio of the total array area to the land area in the system.

2 'Pitch' and 'tilt' are used interchangeably in this thesis. Generally, structural engineers refer to the *pitch of a roof* while PV engineers refer to the *tilt of a PV array*.

3 The optimal tilt of south-facing PV arrays in the Netherlands for annual energy yield is around 35°. This is considered a high tilt for a carport.

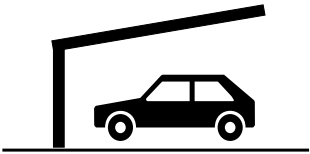
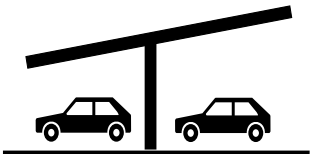
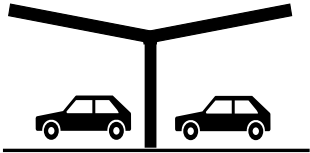
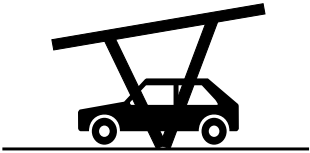
Table 2.2: Most common carport structures (based on Jackson and Hartnell [11])

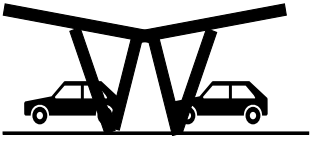
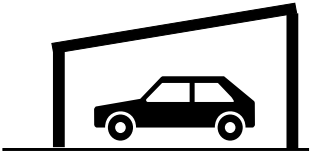
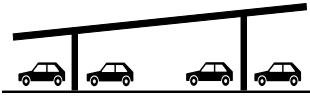
Support frame	Pitch	Single row	Double row
T-frame	Monopitch		
	Duopitch	-	
V-frame	Monopitch		
	Duopitch	-	
Portal frame	Monopitch		

Duopitch roofs are often chosen because they are less sensitive to the azimuth of installation. As a result, they can be used in most locations. Another benefit is structural: the loads on the structure in duopitch roofs are more balanced.

Carports in large parking lots are typically designed for perpendicular parking, which is characterised by space efficiency, simplicity of design and user-friendliness. The alternatives, like parallel parking, angled parking, herringbone parking and overlapped parking are not considered here, though similar design principles apply. In the Netherlands, the guidelines and regulations on the design of parking lots of public spaces are provided in NEN 2443: *Parkeren en stallen van personenauto's op terreinen en in garages* [12], which has been used throughout this thesis.

2.2.3 EV SUPPLY EQUIPMENT AND CONTROLLED CHARGING



Electric Vehicle Supply Equipment (EVSE) in Europe is of several types, and can be classified based on connector type, power rating and so on. An overview of charging infrastructure currently in use in Europe is provided in Table 2.3. These differ from the standards used in other parts of the world, such as the USA, Japan and China.

At lower powers (< 50 kW), Alternating Current (AC) is used, with on-board rectification, to deliver Direct Current (DC) to the traction battery within the EV. EVs produced by all Original Equipment Manufacturers (OEMs) in Europe are compliant with IEC 62196-2 Type 2 connectors, which deliver either 1 phase or 3 phase AC. These are the most common types of chargers, typically located in residential, workplace, semi-public and public locations.

At higher powers, the larger power electronics, conductors and active cooling increases the weight of the rectifier. To lighten the weight of the vehicle, the rectifier is placed off-board, with DC delivered to the vehicle. The placement of the rectifier off-board necessitates a higher degree of communication between the vehicle and the charge point, so that the power output from the rectifier matches the needs of the battery as determined by the Battery Management System (BMS). The presence of this additional communication interface also enables the higher degrees of control of the battery required for V2G operation.

In Europe, DC chargers are split across the CHAdeMO and Combined Charging System (CCS) standards, with vehicles from various OEMs compatible with one or the other. However, in recent years the CCS has emerged as the dominant European standard, with new EV models from historically CHAdeMO compliant OEMs like Nissan (Ariya) and Groupe PSA (Citroën ë-C4, Peugeot e-208) choosing CCS rather than CHAdeMO compatibility. DC fast chargers are typically located along highways, pick-up and drop-off parking as well as charging locations for EV fleet/commercial operators, such as taxi stands.

Table 2.3: Charging standards, power ratings and connectors in Europe (Source: [13–16])
 Image courtesy: *Wikipedia, phoenixcontact.com, evchargeplus.com*

Power type	Power rating (kW)	Maximum current (A)	Connector type	OEMs
AC 1 phase	3.7	16		All
	7.4	32		
AC 3 phase	22	32	IEC 62196-2 Type 2	
	44	63		
DC	62.5	125		Nissan, ¹ Mitsubishi, Kia, Citroën, Peugeot, Tesla (with adapter)
	400	400		
DC	50	125		BMW, Daimler, Volkswagen, Honda, Hyundai, Tesla (with adapter) ²
	750	500		

¹ Not all vehicle models from these OEMs are Chademo compatible

² Tesla vehicles in Europe have not needed adapters for CCS charging since 2019.

Controlled EV charging involves changing the voltage and current exchanged with the EV battery based on communicated external signals. The communication required for this control is managed differently with AC and DC chargepoints. An overview is provided in Fig. 2.1. Although the external signal is provided over the internet protocol (IP), there are several specific protocols, depending on the type of information and the different actors involved in the communication⁴. An overview of these different protocols is provided in [17].

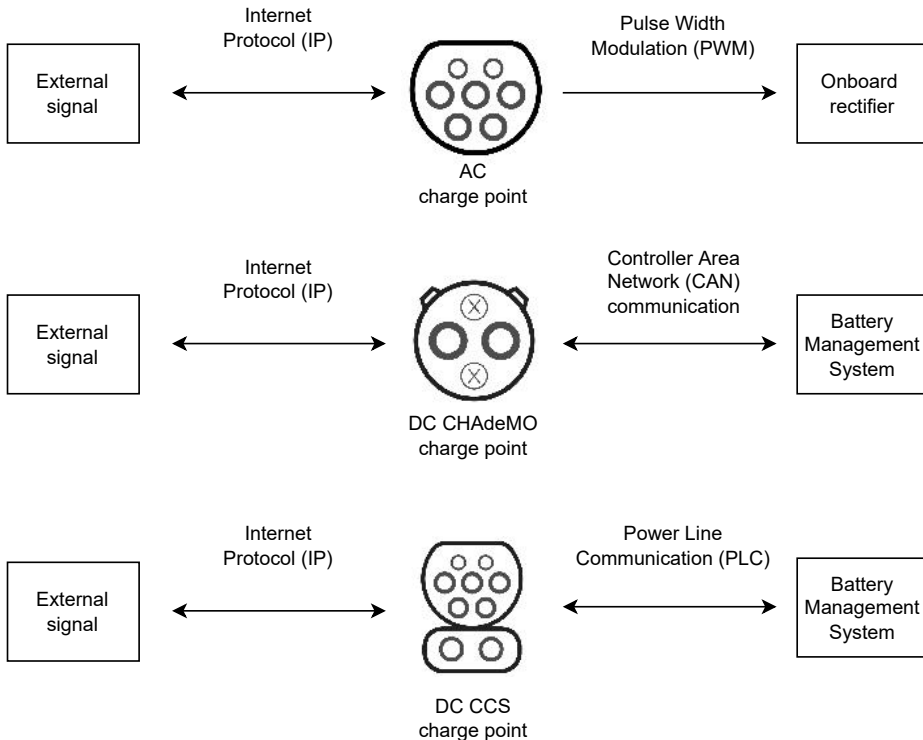

Figure 2.1: Communication for control of EVs (based on [18, 19])

In AC charging, the offboard charger sends a Pulse Width Modulation (PWM) signal over the control pin to communicate a constraint on the maximum charging power to the vehicle's onboard rectifier. The value of this constraint is altered by varying the duty cycle of the communicated signal. The charging current to the battery is modified based on the signal provided.

With DC charging in CHAdeMO, rectification and control take place offboard and the BMS communicates battery parameters to the offboard charge point over a Controller Area Network (CAN) bus. In DC charging over CCS, only the rectification occurs offboard. The

⁴ Additional information on actors involved in the EV charging ecosystem is provided in section 2.3

charge point and BMS negotiate a setpoint based on the external signal provided to the charge point and the battery parameters such as temperature, voltage and State of Charge (SoC). Once the setpoint is agreed upon, the EV sends the setpoint to which the offboard charge point responds.

In this thesis, parking at semi-public locations is analysed, which requires low power ratings and charging speeds. These conditions are also suited for controlled charging. Hence, AC chargers which are of IEC 62196-2 Type 2 are considered. Further, at such locations, charging stations are required to be accessible for all visiting EVs. The split standard in DC charging makes DC-based infrastructure non-universally accessible. However, for the specific cases where V2G is used, DC charge points have been considered, as described in the following section.

2.2.4 VEHICLE-TO-GRID (V2G) CHARGE POINTS

The V2G concept involves the use of Plug-in Electric Vehicles (PEVs) to provide energy storage services to energy utilities, while generating additional revenues for vehicle users [20]. Specific applications of the discharged power have led to terms like Vehicle-to-Load (V2L), Vehicle-to-Home (V2H) and Vehicle-to-Building (V2B), with Vehicle-to-X (V2X) being the generic term.

Charge points and vehicles which are V2X compatible are currently commercially available, with examples provided in Table 2.4. All these vehicles and charge points operate on the CHAdeMO standard, whereby the charge point controls the current exchanged with the EV battery, communicating with the BMS through CAN bus signalling in real time.

V2X enabled on the CCS protocol is still in development, after the recent publication of the ISO 15118-20 standard, which is seen as a necessary pre-requisite for interoperability and scaling [21, 22]. DC based V2X compatible charge points typically have a much lower power ratings (< 20 kW) than DC fast chargers, which are designed for power transfer exceeding 50 kW. However, since the rectifier is located off-board, these chargers are still more expensive than conventional AC charge points.

V2X with AC is also being used in pilot demonstrations, particularly with Renault ZOE as in [23, 24]. Some models are already commercial in the USA, with an IEC 62196-2 Type 1 connector [25]. The advantage is the lower cost of the charge point, since the vehicle's onboard rectifier is replaced by a bidirectional converter. The disadvantages are the additional electronics and isolation needed within the limited space available inside the vehicle, leading to higher vehicle weight and cost.

Table 2.4: Examples of V2X compatible vehicles and charge points commercially available in Europe (Source: [26, 27])

VEHICLES			
	Vehicle model	Connector	Vehicle type
1	Nissan LEAF (2013 model onwards)		BEV hatchback
2	Nissan e-NV200	CHAdeMO	BEV light commercial van
3	Mitsubishi Outlander		PHEV sports utility vehicle
CHARGE POINTS			
	Manufacturer	Connector	Power rating (kW)
1	EVTEC		10 and 20 kW
2	Indra	CHAdeMO	7.4 kW
3	eNovates		10 kW

2.3 ACTORS INVOLVED IN THE EV CHARGING ECOSYSTEM

There are several actors involved in the EV charging ecosystem. These can differ considerably globally depending on the degree of liberalisation of the electricity sector, the maturity of the EV market, the business cases under consideration and even across different brands of PEVs⁵.

The main actors and their relationships are depicted in Fig. 2.2. It is an elaboration of the ISO 15118 model described in [28], and retaining the same terminology as in the standard [29], though with some modifications.

⁵ It is important to note that while there are some overlaps with the actors in the PV ecosystem at the installation and grid-side activities, these are typically distinct industries.

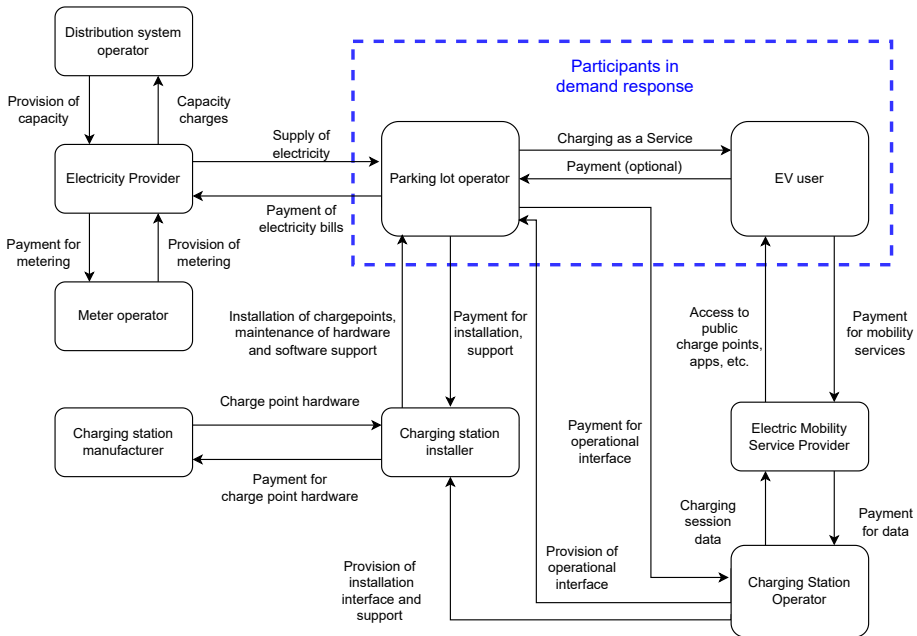

Figure 2.2: Simplified overview of actors and their relationships in the EV charging ecosystem

These actors are described below:

1. The *vehicle user* is the person using the (plugin electric) vehicle. The vehicle user has driving and mobility-related needs, makes decisions about charging, provides data (and perhaps payment) via a user interface and may respond to signals provided via the same interface.
2. The *parking lot operator* is the owner of semi-public or private real-estate where charging stations are located. The parking lot operator is responsible for providing charging services to the vehicle users. The parking lot operator is in charge of choosing a location for charging stations, ensuring that the charging stations are operational, providing charging services to and paying for the energy consumed by all charging stations.
3. The *Electric Mobility Service Provider (EMSP)* is the party with whom the vehicle user has a contractual agreement for charging services at public locations. These services include identification, authentication, roaming, aggregation of transactions and billing.
4. The *charging station manufacturer* is the original equipment manufacturer of the charging station hardware.

5. The *charging station installer* is the entity responsible for installing and commissioning of the charging station on the terrain of the parking lot operator.
6. The *Charging Station Operator (CSO)*⁶ is responsible for developing software on the charging stations, for use by different stakeholders. The CSO provides the charging station installer with the interface for initial commissioning of the charging station. The CSO provides the parking lot operator with an interface to monitor the utilisation, electricity consumption, downtime, diagnostics, etc. and control access and set tariffs. The CSO provides the EMSP with the charging session data and the availability of charging stations.
7. The *electricity provider* is responsible for the wholesale purchase of power for resale to customers through a contract. The electricity provider may trade electricity in markets or restructure tariffs to influence customer electricity profiles.
8. The *Distribution System Operator (DSO)* is responsible for the design, maintenance, development, and operation of the distribution system to facilitate the delivery of electricity to customers.
9. The *meter operator* is responsible for the installation, monitoring and maintenance of meters for electricity customers and disclosure of the metered values to other stakeholders.

In this thesis, the parking lot operators and vehicle users are participants in demand response events. The parking lot operator participates by setting the limits on power capacity available at the EV charge point, and communicates the lack of capacity for charging while the vehicle users respond to this communication by adjusting the charging profile. On the other hand, the main beneficiaries of the demand response from PEVs are parking lot operators and DSOs. Parking lot operators benefit through the reduction in the costs associated with the provision of charging as a service for the vehicle users at the parking lot. DSOs benefit through a reduction in the costs associated with the development and operation of distribution level grid assets beyond the point of common coupling, which are required to facilitate the delivery of electricity to connected customers.

Unlike the ISO 15118 model described in [28], where CSOs are responsible for ‘installation, operation of charging infrastructure and management of electricity’, in this thesis, the CSO role is disaggregated into other actors, amongst whom the listed tasks are divided. Parking lot operators monitor the performance of the charging stations through performance indicators, CSOs provide the software interface for this monitoring

⁶ The term Charge Point Operator (CPO) is commonly used in literature, but is now avoided due to trademark concerns.

as well as remote diagnostics and charging station installers are involved at the specific stages of installation, commissioning and onsite repair (after remote diagnosis). This disaggregation of roles is important from an infrastructure planning perspective, as is the case in this thesis, but may be less valid from contractual perspective since these are informal non-contractual relations. They are also important from a software development or human-computer interaction perspective. Installers have different licenses and levels of authorisations than parking lot operators for the use of the same software.

Although the main actors are represented in Fig 2.2, it is a simplified depiction of the EV charging ecosystem. It does not include various technical services such as cloud storage and payment handling services⁷, electricity grid and electricity market actors and various regulatory bodies. Additionally, it does not include actors who are involved in alternative models and business cases, such as vehicle fleet managers or vehicle leasing services. Emerging roles such as aggregators, who are mediators between electricity consumers and electricity markets are also not explicitly mentioned, though in the current EV charging ecosystem, aggregator roles overlap with EMSPs to a considerable extent⁸.

2.4 LIMITATIONS OF THE CURRENT GRID CAPACITY TO TRANSPORT ELECTRICITY

The demand for peak electricity is expected to rise as a result of electrification of passenger mobility. Various indicators of capacity constraint violations show the insufficient capacity of the grid to transport electricity to meet peak loads at various voltage levels. The scale of grid reinforcement required to transport peak electricity with 2030 decarbonisation targets is very large, and will increase with further decarbonisation after 2050.

2.4.1 ESTIMATED INCREASE IN DEMAND FOR CAPACITY

Several studies in different countries show that both BEV and PHEV drivers prefer charging at their residences [33–36]. The peak demand caused by the charging of EVs at residential locations coincides with existing peak demand in the grid during early evening hours, leading to an increase in peak loads. This effect is investigated in several different regions around the world.

Klettke et al. [37] analysed the impacts on EV charging based on projections for 2030 for the EU27+6 countries. The passenger EV fleet of 38 million vehicles (about 7% of the total passenger fleet) consumes about 2% of total electricity demand of about 4400

⁷ Further details may be found in [30]

⁸ For further descriptions of aggregators, their roles and business models, refer [31, 32]

TWh⁹. For a scenario considering immediate charging, the peak load for evening charging is found to increase across all countries. As an example, in France the peak load is found to increase by 4 GW or about 3.7 % to accommodate immediate charging in 2030. With the expected acceleration in EV adoption in Europe after the “*Fit for 55*” package, the figure here are expected to be an underestimation.

A similar study was conducted in the US, considering low, medium and high EV adoption scenarios, corresponding respectively to around 4 (2%), 15(8.3%) and 40 million (22%) EVs in the US fleet in 2030 [39]. Depending on the geographical location, the peak power is found to increase by 0.65 to 1.8 kW per EV. Accommodating charging at these scales is estimated to require increments of between 2.5 GW (0.2%) for the low adoption scenario and 75 GW (6.25%) for the high adoption scenario by 2030.

Crozier et al. [40] conducted a study considering the impact of a 100% electrified passenger vehicle fleet in the UK. A bottom-up model is built, considering documented travel behaviour, vehicle type, charging location and distance-based vehicle energy consumption. Uncontrolled charging of the fleet was found to require a 20 GW (~23%) increase in total power capacity.

It is notable that based on the estimations of peak demand, studies often focus on the increased generation capacity required at the national or similar level and neglect the transportation capacity of the grid needed to deliver it from the point of generation to the point of load.

On the production side, the power generated by a large number of solar installations in realtime scales linearly with the total installed capacity¹⁰. While the total installed capacity of large solar parks is well known in the Netherlands due to compliance requirements, total installed capacity in the distribution grid remains uncertain [42]. However, ambitious future targets for installed solar capacity can serve as a basis for calculation of peak solar generation.

The Dutch government aims to have 26 GWp of solar installed capacity by 2030 [43, p. 166], almost twice the estimated installed capacity of 14.25 GWp by the end of 2020 [6, 8]. This 26 GWp will generate through utility scale solar 17 TWh of the 35 GWh that is to be produced by renewables on land as per the Dutch Climate Agreement [44, p. 33] as well as 7 TWh through distributed solar on residential rooftops [45, p. 6]. This large increase in solar installed capacity is expected to lead to significant demand for peak power transport capacity.

⁹ The study used the EUCO30 scenario for 2030, as published by the European Commission. For further details on the scenario used in this study, refer Directorate-General for Energy (European Commission) et al. [38]

¹⁰ Refer Ponsukcharoen [41] for empirical evidence and discussions

2.4.2 CONSEQUENCES OF VIOLATIONS OF GRID CAPACITY CONSTRAINTS

Several studies have analysed, both through simulation as well as through measurements, the effects of violations of the capacity constraints in grid infrastructure as a result of both electrical vehicle charging and solar installations. A few important studies are described below.

Putrus et al. [46] modelled a distribution network with a low voltage (400 V) level feeder serving 100 individual households. The effects of single phase uncontrolled residential charging on the power flow under 10%, 20% and 30% EV usage amongst the households is investigated. Each 10% increase in houses with EVs is found to result in an 18% increase in maximum demand. Voltage effects are found to be network specific and dependent on the placement of charge points along the feeder, with the ends of feeders identified as particularly vulnerable. Regulatory limits of -5% can be violated at the feeder ends even with 10% EV adoption while the use of On Load Tap Changers (OLTC) in transformers maintained the voltage at most substations upto around 20% penetration.

Pieltain Fernández et al. [47] modelled a real distribution network with several voltage levels serving an urban area with residential customers. The network investment requirements for accommodating EV fleet shares of 35%, 51% and 62% with uncontrolled charging were calculated to be 7%, 15% and 19% respectively relative to a no-EV baseline. The highest fraction of investment was required at the low voltage level, and the investment in residential areas is expected to be higher than that required in industrial areas.

Verzijlbergh et al. [48] used an aggregated approach to analyse the impacts of uncontrolled EV charging on a large number of networks rather than detailed analysis of individual networks. Peak demands in transformers are modelled as a function of historic load data, EV penetration and driving patterns with a view to gain a system level understanding. For uncontrolled charging at EV penetration of around 75%, the rated capacity of 40% of low voltage transformers is exceeded with charging at 3kW, while the rate capacity of 49% of them is exceeded with charging at 10 kW.

Dubey and Santoso [49] provide an extensive review of the impacts of EV charging on residential distribution systems. The review describes the impact of capacity violations on assets such as the reduction of transformer lifetime as well as the effects on distribution power quality, such as under-voltage conditions and voltage imbalances across phases.

Cross and Hartshorn [50] present the results obtained from My Electric Avenue, a large scale trial conducted in the UK. 200 EVs were given to trial participants and their charging behaviour was monitored over 18 months. Clusters of EV charging were created at nine residential and one industrial location to create a real world simulation of high EV penetration and study the impact on low voltage network feeders. The After-Diversity Maximum Demand (ADMD) was calculated as a key metric for capacity planning, describing the peak demand per customer after accounting for the differences

in timings since their behaviours are not synchronised. High penetration of EV users were found to approximately double this value from 1 kW per customer to about 2 kW per customer.

On the production side, the peak power production of solar powerplants in the Netherlands has already led to congestion in the eastern provinces of the country [51]. Scarcity of available capacity has also led to an increasing number of solar project delays and cancellations in recent years. About 15% of the 222 respondents to a survey conducted on SDE++ awardees that failed to be implemented between 2017 and 2020 cited grid capacity as a reason for project failure [52]. Since November 2020, Dutch solar projects requiring a new large-consumer connection to the grid have been given a maximum connection capacity of 70% of the peak solar installed capacity [53]. This restriction was imposed to reduce the negative effects of the scarcity of transport capacity for peak power in the grid on the speed and success-rate of solar projects. The consequences of high solar are also being reported in the form of voltage deviations in the medium voltage grid, in the eastern parts of the country with a large number of new solar installations [54].

2.4.3 WHAT DOES GRID REINFORCEMENT INVOLVE?

The reinforcement of electricity grid infrastructure includes several tasks such as site selection, land acquisition, consultation with other public authorities, investigations into the effects on local communities and the environment, design, tendering, procurement, safety checks and so on. As such, these projects tend to take time and are expensive. Tables 2.5 and 2.6 each provide the economic costs, land area and timescales required for grid reinforcement projects for substations and lines in the Netherlands.

Table 2.5: Land area, cost and project lead time for replacement of substations at various voltage levels
(Source: Netbeheer Nederland [55])

Voltage level	Power rating	Land requirement	Lead time	Cost estimate* € ₂₀₁₉
Extra High/High Voltage substation	>500 MVA	40,000 to 100,000 m ²	7 to 10 years	>100 million
High/Intermediate High Voltage substation	100 to 300 MVA	15,000 to 45,000 m ²	5 to 7 years	>25 million
High/Medium Voltage substation	100 to 300 MVA	15,000 to 40,000 m ²	5 to 7 years	>25 million
Intermediate High/Medium Voltage substation	20 to 100 MVA	2,000 to 10,000 m ²	2.5 to 5 years	1.5 to 10 million
Medium Voltage substation	10 to 40 MVA	200 to 4000 m ²	2.5 to 3 years	1.3 to 6.5 million
Medium/Low Voltage substation	0.2 to 1 MVA	10 to 35 m ²	0.5 to 1 year	35 to 250 thousand

* Excluding the costs of land acquisition

Table 2.6: Land area, cost and project lead time for replacement of lines at various voltage levels
(Source: Netbeheer Nederland [55])

Voltage level	Power rating	Corridor width	Lead time	Cost estimate € ₂₀₁₉ /m
Extra High/High Voltage line	> 500 MVA	± 100 m	7 to 10 years	5 to 10 thousand
High Voltage cable	100 to 300 MVA	± 10 m	5 to 7 years	1 to 5 thousand
Intermediate High Voltage cable	100 to 300 MVA	± 10 m	1 to 3 years	300 to 1000
Medium Voltage cable	20 to 100 MVA	1 to 10 m	0.5 to 3 years	100 to 400
Low Voltage cable	0.2 to 1 MVA	± 1 m	0.5 to 1 year	70 to 150

Individual capacity bottlenecks at the lower voltage levels have lead times of a few years. However, the scale of the problem is seen in Fig. 2.3. Fig. 2.3(a) shows the available capacity within the low voltage grid for electricity consumption while Fig. 2.3(b) shows the available capacity for production. Significant parts of the low voltage grid face structural congestion in consumption in the north and the west, while the entire east faces experiences congestion in production. Thus, the expansion of the low voltage grid is nearly a nationwide exercise.

The issue is also critical at higher voltage levels. High and extra high voltage transmission projects require lead times of as long as a decade. Individual substations and the lines connecting them cost millions in investment. Additionally, community support and acceptance for changes in landscape caused by overhead transmission grid infrastructure are known to be significant barriers for the development of these projects [56]. Capacity at higher voltage levels is also scarce (see Chapter 1, Fig. 1(a)) and will need to be upgraded to enable domestic and international transportation of electricity from production sites to consumption centres.

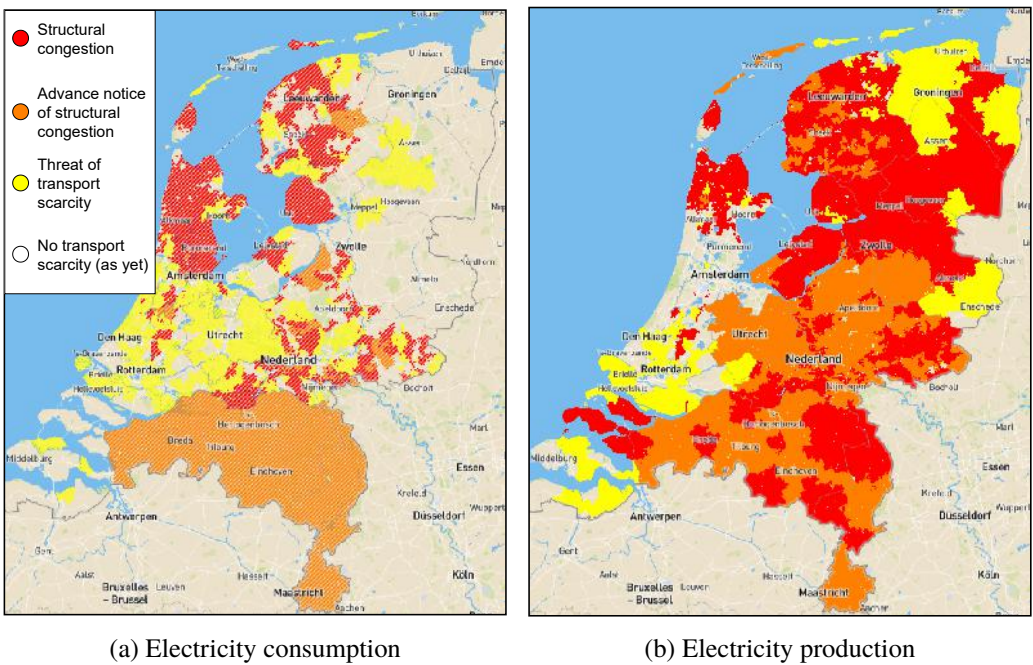

Figure 2.3: Availability of capacity in the Dutch low voltage grid (3x80A connections)
(Source: Netbeheer Nederland [57] 16th June 2022)

2.5 THESIS POSITIONING AND KNOWLEDGE GAP

Several works have studied the technical requirements for achieving a high share of renewables in the future electricity grid or energy system. However, the debate on technical feasibility is overwhelmingly dominated by feasibility of *electricity production* from various sources with insufficient consideration of the requirements for transportation of the generated electricity from point of generation to point of demand with high system-level reliability.

For example, in 2009, Sovacool and Watts [58] described the technical feasibility for achieving high shares of renewable penetration mainly in terms of solar, wind and hydro power plant characteristics. As recently as 2020, Moriarty and Honnery [59] frame their arguments for feasibility purely in terms of adequacy of generation capacity to meet future energy demands as projected by the IEA. In both these studies, which are representative of a larger body of literature, electricity transportation requirements, a significant part of the ‘*how*’ of the anticipated decarbonisation of the electricity sector, are largely neglected.

In 2011, Delucchi and Jacobson [60] estimated the requirements for a world powered 100% by wind, solar and hydropower in terms of matching supply with demand for reliable energy, associated transmission costs and policies¹¹. Seven proposed solutions for matching supply and demand, which are found in various forms to recur in both previous and subsequent literature:

1. the interconnection of geographically dispersed generation to reduce variability
2. use of complementary and deployable power plants as backup
3. use of demand response
4. planned production overcapacities and power-to-gas conversion of overproduction
5. generation-side storage in batteries
6. demand-side storage, primarily through V2G
7. weather forecasting for better supply management

The focus of integration is on supply (points 1, 2, 4, 7), demand (point 3) and storage (points 5, 6). The requirements for the grid capacity to match supply with demand in time as well as to transport supply *to* demand in physical space are not adequately investigated, a deficiency in the study that also continues in later literature.

¹¹ This was the second part of a two-part study, where the first part focused on the requirements for a world powered 100% by wind, solar and hydropower in terms of the energy resources, technologies, land use and materials [61]

The work recognises on the one hand the need for the connection of geographically dispersed solar and wind generation sites to a common transmission grid to improve the system-level reliability of supply, while on the other hand also recognises that economies of scale favour the construction of large power plants at resource-rich sites for lowering both production and transmission costs of individual projects, which we see today in practice. However, the physical modelling of the grid is not performed in this study (or in future studies by the same authors [62, 63]). Rather, assumptions are made regarding the additional transmission distances needed for the integration of distributed production sites, based on which costs are estimated.

A particular oversight is the requirement of sufficient grid capacity to enable high-reliability operation in specific locations. As an example, the Netherlands and other parts of northwestern Europe experience phenomena known as “*dunkelflautes*”: extended periods¹² during which the sun doesn’t shine and the wind doesn’t blow. As Li et al. [64] show through analysis of meteorological data, simultaneous *dunkelflautes* in Netherlands and the neighbouring Belgium are relatively likely. However, the likelihood of simultaneous *dunkelflautes* with countries further away is far smaller, and simultaneous occurrence across the entire continent is extremely rare. During these periods, in the absence of local production from renewables, transmission capacity needs to be very high to accommodate electricity imports for several days continuously.

It is worth noting that even the criticism of Delucchi and Jacobson [60] by Trainer [65], which brings up this point, frames the argument in terms of increased generation capacity required to meet load during *dunkelflautes* rather than transmission capacity¹³. In further exchanges between the authors [66, 67], transmission is only addressed in terms of inter-continental transmission rather than the very real need for intra-continental transmission as well as expansion at lower voltage levels.

Hart et al. [68] conducted a meta-analysis of grid-integration studies in 2012, with the objective of creating a framework to study geographic aggregation, complementarity of technologies and the effects of intermittency, variability and predictability of renewables at various degrees of penetration. However, the study does not consider the grid capacity required at various degrees of penetration, taking a “copperplate” assumption. Based on this assumption, electricity fed in at any location or voltage level in the electricity grid can

12 We use the definition of a *dunkelflaute* provided by Li et al. [64]. According to this, an event is classified as a *dunkelflaute* if the wind and solar capacity factors at the national level both fall below 20% during a particular 60 minute period. Based on this definition, *dunkelflautes* can last for longer than 72 hours in several northern European countries, though the most common events last between 12 and 24 hours. For further discussions on the characterisation, meteorological drivers and the spatial correlations associated with *dunkelflautes*, refer Li et al. [64].

13 “When most of Europe is experiencing calm and cloudy conditions over large regions for days at a time the crucial question is not whether input from wind and sun has been ‘smoothed out’, it is whether there is any significant input at all from these combined sources” [65]

be used to drive loads at any other location or voltage level with zero or negligible losses and no constraints on transportation.

While later studies aim to replace the copperplate assumption, several use highly simplifying assumptions. For example, Elliston et al. [69] aimed to present least-total-cost-of-system options for the Australian National Electricity Market region (south east Australia) based on 100% renewables. While their stated aim was to do away with the copperplate assumption, in practice they did not impose capacity constraints on the interconnections. Interconnection length was used to create a distance-based priority function that informed the economic dispatch. This only addressed the neglect of power losses in the copperplate assumption but not the inherent neglect of transmission capacity constraints.

Similarly, Schädler et al. [70] performed a spatio-temporal analysis for Germany to find the mismatch between the sum of solar and wind power production in each of the 95 ZIP code regions in Germany and the power demand in it. Based on the time-series data of the mismatch in each ZIP code, estimations of the extent of electricity that needed to be transported and stored at the national level were made. As before, the costs of transportation informed the minimisation as a distance-based function, but the constraints imposed by either current or future transmission infrastructure were not considered. Additionally, a copperplate network was assumed within each ZIP code region and the inability of radial distribution grids to transport and distribute power generated within the same ZIP code was overlooked.

In 2015, Loftus et al. [71] conducted an extensive review of decarbonisation scenarios of the energy sector in literature. Their analysis revealed that of the 12 scenarios analysed, only 3 explicitly treated “integration issues” as a constraint for electricity system transformation. The remaining studies either neglected these issues or provided a small discussion. Even among the studies that did consider integration, integration issues were addressed conceptually, rephrasing some or all of the 7 recommendations listed above by Delucchi and Jacobson [60].

Later, in 2017, Heard et al. [72] conducted a review on 24 different 100% renewable electricity systems which were considered detailed enough to be sufficiently credible. They aimed to rate these studies based on four proposed *necessary conditions* to establish the *technical feasibility*¹⁴ of a 100% renewable electricity system. One of the proposed conditions was that the study should “describe and map the transmission requirements for newly installed capacity and/or growth in supply to demonstrate delivery of generated electricity to the user network such that supply meets both projected demand and reliability standards.”. The authors found only 4 of the 24 studies

¹⁴ Heard et al. [72] defined the technical feasibility to be “‘possible within the constraints of the physical universe’, so a demonstration of feasibility requires that evidence is presented that a proposed system will work with current or near-current technology at a specified reliability.” This is distinguished from both economic viability as well as social viability.

to satisfy the stated condition for their model. However, since they state that none of the studies considered the increased distribution level infrastructure needed, it is debatable whether even these four actually demonstrated the reliable delivery of power from generation to user. This oversight again shows the tendency for capacity constraints in the grid at all voltage levels to be overlooked in literature investigating roadmaps towards the decarbonisation of the electricity system.

Among the studies that study power capacity, Rodríguez et al. [73] and Becker et al. [74] both estimate the transmission capacity requirements for the European continent in 2050 with very high shares of variable renewable energy in the grid mix. Rodríguez et al. [73] estimates the need for an additional 85 GW of total transmission capacity relative to the baseline of 73 GW available in 2011¹⁵. Similarly, Becker et al. [74] estimates an approximate doubling of transmission capacity. Both these are estimated to capture about 70% of the value of copperplate transmission in terms of reducing the need for deployable power plants among other scenarios. In comparison, ENTSO-E, in their Ten Year Network Development Plan 2020 [76] estimates an additional 128 GW of additional cross border reinforcements relative to the 2020 scenario¹⁶, which are also estimated to capture about 70% of a copperplate transmission system in terms of reduced curtailed power. This is comparable to the anticipated 148 GW expansion estimated by the more recent study by Zappa et al. [77]¹⁷, where the requirements of transmission for a high renewable integration scenario is performed. None of these studies investigated the low voltage grid.

Notably, there is a tendency in the literature describing the normative “high renewables” future to neglect transportation capacity of the electricity grid. When it is addressed, it is commonly restricted in scope to a single voltage level - either transmission or distribution level. In single technology focused integration studies, such as on EVs, there is greater recognition of the problems associated with integration, though the needs for a “high renewables” future are missed, since the emergent solutions target symptoms, such as voltage drops and transformer overloading, rather than the broader requirements.

In particular, there is a knowledge gap related to incorporating the needs of a “high renewables” future electricity grid into local projects from the design level. That is the gap that this thesis aims to address with respect to the integration of solar parking lots for electric vehicle charging in a grid with limited capacity.

15 The 2011 values were sourced from ENTSO-E [75]

16 These upgrades are planned as 35 GW which are already under construction for use by 2025, 50 GW to be added by 2030 (€17 billion) and 43 GW (€28 billion) to be added by 2040.

17 We use the *Free Res scenario* from the paper, where the model is free to optimise all renewable generation capacity (except) and transmission capacity in Europe to determine the least-cost mix of generation technologies and transmission infrastructure investments which can reliably meet electricity.

2.6 SOLAR CARPARKS FOR EV CHARGING: A LITERATURE REVIEW

With a scarcity in capacity in the grid, solar carparks with EV charging stations present an opportunity to generate electricity at the point of load, reducing the need for additional capacity. There is considerable literature on systems involving solar energy and EV charging. A chronological review of the most important developments is presented below.

Birnie [78] suggested installation of solar generation capacity at locations where daytime charging would be convenient. Basic calculations suggested that solar installations designed based on parking area requirements for workplace parking lots in New Jersey, USA, were able to satisfy the energy requirements for commuting (15 to 20 mile radius) in both summer and winter. Based on this, workplaces were identified as a particularly suitable location since PEVs remain parked for long hours during daytime solar generation.

Neumann et al. [79] analysed the technical generation potential through installing solar carports at 48 parking lots located in the medium-sized Swiss city of Frauenfeld. These parking lots together provided space for about 4240 vehicles to park or about 30% of the private vehicles registered in the city. Depending on the assumptions of tank-to-wheel efficiencies, the energy yield was calculated to be able to meet between 15% and 40% of the total charging demand of a fully electrified vehicle fleet.

Denholm et al. [80] further analysed workplaces with solar carports in the Electric Reliability Council of Texas (ERCOT) synchronous area in the US, finding co-benefits through workplace charging and distributed solar generation. Workplace charging on its own is found to lead to increased demand in the afternoon and higher ramp in the morning. The increased demand and higher ramp are both reduced through PV deployment at low shares (5 to 10%). At higher PV penetrations (>10%), utilities face curtailed midday solar energy and steep evening ramps. These are conversely reduced through the integration of midday charging for PHEVs (<30% fleet penetration). At high PV penetrations, controlled charging is recommended as a means to further increase the share of curtailed energy used as well as to enable the PHEV load to maintain thermal generation at the minimum generation point required for operational reserves.

Tong et al. [81] investigated the feasibility of an offgrid solar array with second life batteries to reliably meet the energy demands of Plug-in Hybrid Electric Vehicle (PHEVs) in Davis, California. A prototype single vehicle solar carport with a 1.44 kWp PV array and a 13.9 kWh Li-ion iron phosphate (LFP) battery pack was designed and built. The operation of a slightly larger system with a 2.16 kW PV array and the same battery capacity was simulated with a workplace charging demand profile of 10 kWh/day, with irradiance profiles for various US cities. The number of days in a year on which the proposed design could meet the assumed 10 kWh daily load was found to vary

greatly depending on available irradiance profiles, ranging from 98 days in Chicago, Illinois (41.9 °N latitude) to 244 days in Phoenix, Arizona (33.4 °N latitude).

Goldin et al. [82] and Erickson et al. [83] extended the analysis of solar carports at workplaces to identify positive externalities associated with their implementation. Emission reduction of the EV fleet and enabling EV adoption through accessible charging are listed among the various broader benefits of mobility electrification and solar energy integration.

Ma and Mohammed [84] were among the first to propose an energy management system for a solar carport system at workplace. The study analyses a grid-tied DC microgrid located at a workplace parking lot, integrating a 75 kWp solar array with 350 V2G compatible chargers. Stochastic models are used to simulate PV generation profiles and vehicle arrival patterns over a year and electricity prices are assumed to be known in advance. An energy management system uses a fuzzy logic-based control system to achieve several objectives: lowering the costs of charging, reducing the duration and magnitude of undervoltage events and providing at least 80% SoC at departure to all parked vehicles.

Kam and Sark [85] analysed a microgrid located at a workplace in the Netherlands, which integrated a 31 kWp PV array and 2 EV charge points along with the office demand, internet servers and three households. The EVs, a Tesla Model S and a Nissan LEAF, were used as part of a car-sharing scheme, after which they were returned to the charge points. Control algorithms are developed to reduce peaks and increase solar self-consumption in the microgrid, formulate as a rules-based algorithm to run in realtime and as a Linear Programming Problem (LPP) to be run once a day at midnight. Based on the achieved increases in self-consumption and the reduction in peak load, the LPP approach is found to provide superior results even when uncertainty in PV yield is considered.

Bhatti et al. [86] reviewed power converter topologies which used to charge PEVss from solar photovoltaics. An overview of various topologies designed for grid-tied and standalone systems is provided and converter designs with various functionalities like Maximum Power Point Tracking (MPPT), bidirectionality (i.e. rectification and inversion), isolation, curtailment and islanding are discussed.

Nunes et al. [87] reviewed the use of parking lots to charge electric vehicles with solar energy. Based on the review, the objectives of smart charging are classified as shown in Table 2.7.

Table 2.7: Objectives of system control in solar carports for EV charging (based on Nunes et al. [87])

Objective	Number of studies
1 Maximising use of renewable energy	8
2 Provision of adequate SoC at departure	4
3 Maximising operational profits for the parking lot operator	1
4 Maximising operational profits for the vehicle user	1
5 Minimising costs of charging	6

Figueiredo et al. [88] analysed a 1045 vehicle solar parking lot for EV charging at a commuter parking lot in Almada, Portugal. A 1 MWp solar array was considered for the financial payback time under various conditions. Inclusion of Li ion storage, controlled charging based on a proposed logic, gradual deployment of charging stations over the duration of the project and provision of ancillary services are considered. For the 2017 price assumptions considered in the study, a financial payback of around 7 years is calculated without storage, rising to 14 years if battery storage is included.

Chandra Mouli [89] compiled several important studies in a doctoral thesis including [90–92]. In [90], the considerations for the design of a solar parking lot for charging EVs at a workplace in the Netherlands are investigated. An integrated DC linked device is proposed connecting a 10 kWp solar array to a 10kW DC charge point. The operational performance over a year is analysed based on energy exchanged from the grid. For reducing this exchange, a small storage capacity of 5-10 kWh is proposed, leading to a 17-25% drop in energy exchanged. Increasing the storage capacity further results in rapidly diminishing returns in terms of grid exchange reduction.

In [91], the operation of a 10 kW PV array integrated with a 10 kW V2G compatible EV charge point for a single vehicle is analysed. The objective function governing the control of the vehicle charging is formulated as a mixed integer linear programming problem considering the forecasted solar power, the grid power constraints, a dynamic purchase tariff and fixed and dynamic feed-in tariffs. The solution provides the lowest cost of operation for the parking lot operator and the operation of the system is simulated over a single day with high solar irradiance. The system is found to operate more effectively when scaled and operation in V2G mode is found to be non-economical primarily due to the high battery degradation costs (0.038 €/kWh) and battery-charger roundtrip losses (10%).

In [92], a modular 10 kW solar bidirectional charger was developed, enabling both CHAdeMO and CCS compliant DC charging. Permissible power flows included the

charging of an EV from the grid, the charging of an EV from a 10 kW solar array, the feed-in of solar energy to the grid and the discharging of an EV to the grid.

In addition, some studies also investigated the integration of EV charging with distributed PV generation with the objective of reducing the impacts of distributed generation on the grid. Traube et al. [93] proposed a centralised DC-linked converter topology that allows a very small fraction of EV battery capacity (0.05 kWh/kWp installed PV) to reduce the ramp rates of PV feed-in to acceptable values of 10%/minute. Similarly, Brinkel et al. [94] proposed the use of aggregated EV charging control to address voltage flicker in distribution feeders with a high share of installed PV capacity caused by localised cloud transients.

A highly relevant concept for this thesis is the hosting capacity approach to analyse the integration of distributed generation and new consumption (typically EV charging or heat pumps), as presented in [95]. The hosting capacity of a given network is defined as the *'the amount of new production or consumption where the first measurable performance index reaches its limit'*. The performance indices are typically analysed in terms of reliability (such as CAIDI and CAIFI¹⁸) or in terms of power quality (such as voltage deviation), and the limits are typically set by regulations. The hosting capacity approach is an extremely useful tool to guide the investigations on integration studies, while providing comparable results.

The developments in the literature on solar carports can broadly be described in four stages. Early works introduced the concept of solar carports for EV charging and evaluated their potential [78–80]. Later, studies mapped out and estimated the benefits associated with these systems [82, 83, 96]. As the field developed, several papers focused on system level design [81, 84, 85, 90] while others focused on component level design [86, 92]. Most recently, works have looked further at the techno-economic feasibility and business cases of solar carports [87, 88].

The incorporation of the needs of a “high renewables” future electricity grid into local projects from the design level are notably absent in the literature. That is where this thesis aims to contribute to existing work on solar carports for EV charging.

18 CAIDI is the Customer Average Interruption Duration Index and CAIFI is the Customer Average Interruption Frequency Index

REFERENCES

-
- [1] Masson, G., Kaizuka, I., *Trends 2018 in Photovoltaic Applications*. IEA PVPS T1-34:2018. International Energy Agency (IEA), 2018. URL: https://iea-pvps.org/wp-content/uploads/2020/01/2018_iea-pvps-report_2018.pdf.
- [2] Louwen, A., Sark, W. G. J. H. M., Faaij, A. P. C., Schropp, R. E. I., “Re-assessment of net energy production and greenhouse gas emissions avoidance after 40 years of photovoltaics development.” In: *Nature Communications* 7.1 (2016). Number: 1 Publisher: Nature Publishing Group, p. 13728. issn: 2041-1723. doi: 10.1038/ncomms13728. URL: <https://www.nature.com/articles/ncomms13728>.
- [3] Gielen, D., Press, E., Badr, A., Benmarraze, S., Blanco, H., Boshell, F., Chen, Y., Jinks, B., Parthan, B., *Renewable Power Generation Costs in 2020*. Abu Dhabi: International Renewable Energy Agency, 2021. isbn: 978-92-9260-348-9. URL: https://www.irena.org/-/media/Files/IRENA/Agency/Publication/2021/Jun/IRENA_Power_Generation_Costs_2020.pdf.
- [4] Philipps, S., Warmuth, W., *Fraunhofer ISE: Photovoltaics Report*. Freiburg, Germany, 2021. URL: <https://www.ise.fraunhofer.de/content/dam/ise/de/documents/publications/studies/Photovoltaics-Report.pdf>.
- [5] Kumar, A., Melkote, S. N., “Diamond Wire Sawing of Solar Silicon Wafers: A Sustainable Manufacturing Alternative to Loose Abrasive Slurry Sawing.” In: *Procedia Manufacturing*. 15th Global Conference on Sustainable Manufacturing vol. 21 (2018), pp. 549–566. issn: 2351-9789. doi: 10.1016/j.promfg.2018.02.156. URL: <https://www.sciencedirect.com/science/article/pii/S2351978918301963>.
- [6] TenneT TSO, *Annual Market Update 2021*. Arnhem, the Netherlands, 2022. URL: <https://www.tennet.eu/company/publications/technical-publications/>.
- [7] Philipps, S., Warmuth, W., *Photovoltaics Report*. Freiburg, Germany: Fraunhofer Institute for Solar Energy Systems, 2022. URL: <https://www.ise.fraunhofer.de/content/dam/ise/de/documents/publications/studies/Photovoltaics-Report.pdf>.
- [8] Lebedev, A., Akande, D., Coënt, N., Elhassan, N., Escamilla, G., Arkhipova, I., Whiteman, A., *Renewable Energy Capacity Statistics 2022*. ISBN: 978-92-9260-428-8. Abu Dhabi: International Renewable Energy Agency, 2022. URL: https://irena.org/-/media/Files/IRENA/Agency/Publication/2022/Apr/IRENA_RE_Capacity_Statistics_2022.pdf.
- [9] TenneT, *Annual Market Update 2020: Electricity market insights*. Arnhem, the Netherlands, 2021. URL: https://www.tennet.eu/fileadmin/user_upload/Company/Publications/Technical_Publications/Annual_Market_Update_2020.pdf.
- [10] Fthenakis, V., Leccisi, E., “Updated sustainability status of crystalline silicon-based photovoltaic systems: Life-cycle energy and environmental impact reduction trends.” In: *Progress in Photovoltaics: Research and Applications* 29.10 (2021), pp. 1068–1077. issn: 1099-159X. doi: 10.1002/pip.3441. URL: <https://onlinelibrary.wiley.com/doi/abs/10.1002/pip.3441>.
- [11] Jackson, C., Hartnell, G., *Solar car parks: a guide for owners and developers*. St. Blazey, UK: BRE National Solar Centre, 2016. URL: https://www.bre.co.uk/filelibrary/nsc/Documents%20Library/BRE/89087-BRE_solar-carpark-guide-v2.bre114153_lowres.pdf.
- [12] NEN, *NEN 2443: Parkeren en stallen van personenauto's op terreinen en in garages*. NEN 2443:2000. Delft, the Netherlands: Nederlands Normalisatie Instituut, 2013.
- [13] Falvo, M. C., Sbordone, D., Bayram, I. S., Devetsikiotis, M., “EV charging stations and modes: International standards.” In: *2014 International Symposium on Power Electronics, Electrical Drives, Automation and Motion*. 2014 International Symposium on Power Electronics, Electrical Drives, Automation and Motion (SPEEDAM 2014). Ischia, Italy: IEEE, 2014, pp. 1134–1139. isbn: 978-1-4799-4749-2. doi: 10.1109/SPEEDAM.2014.6872107. URL: <http://ieeexplore.ieee.org/document/6872107/>.

- [14] International Electrotechnical Commission (IEC), *IEC 62196-2:2016*. 2016. URL: <https://webstore.iec.ch/publication/24204>.
- [15] International Electrotechnical Commission (IEC), *IEC TS 62196-3-1:2020*. 2020. URL: <https://webstore.iec.ch/publication/59654>.
- [16] Hall, D., Lutsey, N., *Emerging best practices for electric vehicle charging infrastructure*. Washington DC, USA: The International Council on Clean Transportation, 2017, p. 54. URL: https://theicct.org/sites/default/files/publications/EV-charging-best-practices_ICCT-white-paper_04102017_vF.pdf.
- [17] Klapwijk, P. *EV related protocol study v1.1*. Arnhem, the Netherlands: Elaad NL, 2017. URL: <https://www.elaad.nl/research/ev-related-protocol-study/>.
- [18] Zidan, A., Gabbar, H., “Design and control of V2G.” In: *Smart Energy Grid Engineering*. Elsevier, 2017, pp. 187–205. ISBN: 978-0-12-805343-0. DOI: 10.1016/B978-0-12-805343-0.00008-5. URL: <http://linkinghub.elsevier.com/retrieve/pii/B9780128053430000085>.
- [19] Chandra Mouli, G. R., Venugopal, P., Bauer, P., “Future of electric vehicle charging.” In: *2017 International Symposium on Power Electronics (Ee)*. 2017 International Symposium on Power Electronics (Ee). Novi Sad: IEEE, 2017, pp. 1–7. ISBN: 978-1-5386-3502-5. DOI: 10.1109/PEE.2017.8171657. URL: <http://ieeexplore.ieee.org/document/8171657/>.
- [20] Kempton, W., Letendre, S. E., “Electric vehicles as a new power source for electric utilities.” In: *Transportation Research Part D: Transport and Environment 2.3* (1997), pp. 157–175. ISSN: 13619209. DOI: 10.1016/S1361-9209(97)00001-1. URL: <https://linkinghub.elsevier.com/retrieve/pii/S1361920997000011>.
- [21] CharIn, *Vehicle to Grid (V2G) - We bundle 200 companies that make the energy system...* 2021. URL: <https://www.charin.global/news/vehicle-to-grid-v2g-charin-bundles-200-companies-that-make-the-energy-system-and-electric-cars-co2-friendlier-and-cheaper/> (visited on 11/30/2021).
- [22] International Organization for Standardization (ISO), *ISO/DIS 15118-20*. ISO. 2021. URL: <https://www.iso.org/cms/render/live/en/sites/isoorg/contents/data/standard/07/78/77845.html>.
- [23] Brey, B. “Smart Solar Charging: Bi-Directional AC Charging (V2G) in the Netherlands.” In: *Journal of Energy and Power Engineering 11.7* (2017). ISSN: 19348975, 19348983. DOI: 10.17265/1934-8975/2017.07.007. URL: <http://www.davidpublisher.org/index.php/Home/Article/index?id=32150.html>.
- [24] Schram, W., Brinkel, N., Smink, G., Wijk, T., Sark, W., “Empirical Evaluation of V2G Round-trip Efficiency.” In: *2020 International Conference on Smart Energy Systems and Technologies (SEST)*. 2020 International Conference on Smart Energy Systems and Technologies (SEST). 2020, pp. 1–6. DOI: 10.1109/SEST48500.2020.9203459.
- [25] Nuvve Corp. *Nuvve PowerPort: High Power AC charging station*. 2021. URL: <https://nuvve.com/wp-content/uploads/2021/08/nuvve-powerport-single-phase-spec-sheet-aug2021.pdf> (visited on 09/01/2021).
- [26] MacLeod, M., Cox, C., *V2G Market Study - Answering the preliminary questions for V2G: What, where and how much?* Loughborough, England: Cenex, 2018. URL: <https://www.seev4-city.eu/wp-content/uploads/2018/08/V2G-Market-Study-2018.pdf>.
- [27] Chademo Association, *V2X – Chademo Association*. 2021. URL: <https://www.chademo.com/products/v2x-product/> (visited on 09/01/2021).
- [28] Klapwijk, P., Driessen-Mutters, L., Müde, M., *Exploring the Public Key Infrastructure for ISO 15118 in the EV Charging Ecosystem*. Arnhem, the Netherlands: ElaadNL, 2018. URL: https://www.elaad.nl/uploads/files/Exploring_the_PKI_for_ISO_15118_in_the_EV_charging_ecosystem.V1.0s2.pdf.
- [29] ISO Technical Committee, *ISO 15118-1:2019*. ISO. 2019. URL: <https://www.iso.org/obp/ui/#iso:std:iso:15118:-1:ed-2:v1:en> (visited on 11/30/2021).
- [30] Fanti, M. P., Pedroncelli, G., Roccotelli, M., Mininel, S., Stecco, G., Ukovich, W., “Actors interactions and needs in the European electromobility network.” In: *2017 IEEE International Conference on Service Operations and Logistics and Informatics (SOLI)*. Bari, Italy: IEEE, 2017, pp. 162–167. ISBN: 978-1-5090-5847-1. DOI: 10.1109/SOLI.2017.8120988. URL: <http://ieeexplore.ieee.org/document/8120988/>.
- [31] Poplavskaya, K., Vries, L., “Chapter 5 - Aggregators today and tomorrow: from intermediaries to local orchestrators?” In: *Behind and Beyond the Meter*. Ed. by F. Sioshansi. Academic Press, 2020, pp. 105–135. ISBN: 978-0-12-819951-0. DOI: 10.1016/B978-0-12-819951-0.00005-0. URL: <http://www.sciencedirect.com/science/article/pii/B9780128199510000050>.

- [32] Okur, Ö., Heijnen, P., Lukszo, Z., “Aggregator’s business models in residential and service sectors: A review of operational and financial aspects.” In: *Renewable and Sustainable Energy Reviews* 139 (2021), p. 110702. ISSN: 1364-0321. DOI: 10.1016/j.rser.2020.110702. URL: <https://www.sciencedirect.com/science/article/pii/S1364032120309837>.
- [33] Francfort, J. “EV Project Data and Analytic Results.” 2014 DOE Vehicle Technologies Office Review. Idaho Falls, USA, 2014. URL: https://www.energy.gov/sites/prod/files/2014/07/f18/vss137_francfort_2014_o.pdf.
- [34] Smart, J. G., Salisbury, S. D., *Lessons Learned about Plug-in Electric Vehicle Charging Infrastructure from The EV Project and ChargePoint America*. Idaho Falls, USA: Idaho National Laboratory, 2015.
- [35] Hoekstra, A., Refa, N., “Characteristics of Dutch EV drivers.” In: *EVS30 Symposium*. 30th International Electric Vehicle Symposium and Exhibition. Stuttgart, Germany, 2017.
- [36] Hardman, S. “A review of consumer preferences of and interactions with electric vehicle charging infrastructure.” In: *Transportation Research Part D: Transport and Environment* vol. 62 (2018), pp. 508–523. ISSN: 1361-9209. DOI: 10.1016/j.trd.2018.04.002. URL: <https://www.sciencedirect.com/science/article/pii/S1361920918301330>.
- [37] Klettke, A., Moser, A., Bossmann, T., Barberi, P., Fournié, L., *Effect of electromobility on the power system and the integration of RES*. ENER/C2/2014-639. Aachen: RWTH Aachen, 2018. URL: https://ec.europa.eu/energy/sites/ener/files/documents/metis_s13_final_report_electromobility_201806.pdf.
- [38] Directorate-General for Energy (European Commission), *EU reference scenario 2016: energy, transport and GHG emissions : trends to 2050*. LU: Publications Office of the European Union, 2016. ISBN: 978-92-79-52374-8. URL: <https://data.europa.eu/doi/10.2833/001137>.
- [39] Driving Research and Innovation for Vehicle efficiency and Energy, *Summary Report on EVs at Scale and the U.S. Electric Power System*. Department of Energy, USA, 2019. URL: <https://www.energy.gov/sites/prod/files/2019/12/f69/GITT%20ISATT%20EVs%20at%20Scale%20Grid%20Summary%20Report%20FINAL%20Nov2019.pdf>.
- [40] Crozier, C., Apostolopoulou, D., McCulloch, M., “Numerical Analysis of National Travel Data to Assess the Impact of UK Fleet Electrification.” In: 2018 Power Systems Computation Conference (PSCC). 2018, pp. 1–7. DOI: 10.23919/PSCC.2018.8450584.
- [41] Ponsukcharoen, U. “Impact of Distributed PV Generation on Grid Operation.” PhD thesis. Stanford, California: Stanford University, 2017. URL: <https://web.stanford.edu/group/SOL/dissertations/TeeThesis.pdf>.
- [42] Laevens, B. P. M., Bosch, O. t., Pijpers, F. P., Sark, W. G. J. H. M., “Observational daily and regional photovoltaic solar energy production for the Netherlands.” In: *arXiv:2003.01728v2* (2021). arXiv: 2003.01728. URL: <http://arxiv.org/abs/2003.01728>.
- [43] Hammingh, P., Menkveld, M., Daniëls, B., Koutstaal, P., Schure, K., Hekkenberg, M., *Klimaat- en Energieverkenning 2020*. The Hague, the Netherlands: Netherlands Environmental Assessment Agency (Planbureau voor de Leefomgeving), 2020. URL: <https://www.pbl.nl/sites/default/files/downloads/pbl-2020-klimaat-en-energieverkenning2020-3995.pdf>.
- [44] Rijksoverheid, *Climate Agreement*. The Hague, the Netherlands, 2019. URL: <https://www.government.nl/documents/reports/2019/06/28/climate-agreement>.
- [45] Nederlands Vereniging Duurzame Energie, *Hernieuwbare Energiebronnen op Land in de Regionale Energiestrategie (RES)*. 2020. URL: <https://www.nvde.nl/wp-content/uploads/2020/02/NVDE-Hernieuwbare-energiebronnen-op-land-in-de-Regionale-Energiestrategie-feb2020.pdf>.
- [46] Putrus, G. A., Suwanapingkarl, P., Johnston, D., Bentley, E. C., Narayana, M., “Impact of electric vehicles on power distribution networks.” In: *2009 IEEE Vehicle Power and Propulsion Conference*. IEEE, 2009, pp. 827–831. URL: http://ieeexplore.ieee.org/xpls/abs_all.jsp?arnumber=5289760 (visited on 09/05/2016).
- [47] Pieltain Fernández, L., Gomez San Roman, T., Cossent, R., Mateo Domingo, C., Frías, P., “Assessment of the Impact of Plug-in Electric Vehicles on Distribution Networks.” In: *IEEE Transactions on Power Systems* 26.1 (2011). Conference Name: IEEE Transactions on Power Systems, pp. 206–213. ISSN: 1558-0679. DOI: 10.1109/TPWRS.2010.2049133.

- [48] Verzijlbergh, R. A., Grond, M. O. W., Lukszo, Z., Slootweg, J. G., Ilic, M. D., “Network Impacts and Cost Savings of Controlled EV Charging.” In: *IEEE Transactions on Smart Grid* 3.3 (2012), pp. 1203–1212. issn: 1949-3053, 1949-3061. doi: 10.1109/TSG.2012.2190307. url: <http://ieeexplore.ieee.org/document/6204213/> (visited on 02/20/2020).
- [49] Dubey, A., Santoso, S., “Electric Vehicle Charging on Residential Distribution Systems: Impacts and Mitigations.” In: *IEEE Access* 3 (2015), pp. 1871–1893. issn: 2169-3536. doi: 10.1109/ACCESS.2015.2476996.
- [50] Cross, J. D., Hartshorn, R., “My Electric Avenue: Integrating electric vehicles into the electrical networks.” In: *6th Hybrid and Electric Vehicles Conference (HEVC 2016)*. 6th Hybrid and Electric Vehicles Conference (HEVC 2016). 2016, pp. 1–6. doi: 10.1049/cp.2016.0972.
- [51] Braat, M., Tsafarakis, O., Lampropoulos, I., Besseling, J., Sark, W. G. J. H. M., “Cost-Effective Increase of Photovoltaic Electricity Feed-In on Congested Transmission Lines: A Case Study of The Netherlands.” In: *Energies* 14.10 (2021), p. 2868. doi: 10.3390/en14102868. url: <https://www.mdpi.com/1996-1073/14/10/2868>.
- [52] Netherlands Enterprise Agency (RVO), *Monitor Zon-PV 2021 in Nederland*. RVO-183-2021-RP-DUZA. The Hague, the Netherlands, 2021. url: <https://www.rijksoverheid.nl/documenten/rapporten/2021/09/23/monitor-zon-pv-in-nederland>.
- [53] Molengraaf, P., Voorhorst, B., *Convenant Zon Betaalbaar op het Net*. Holland Solar and Netbeheer Nederland, 2020. url: <https://www.nvde.nl/wp-content/uploads/2020/11/convenant-zon-betaalbaar-op-het-net.pdf>.
- [54] Steman, B., Nieuwesteeg, P., Plantema, M., Friele, K., *Verbeteren netinpassing zonne-energieprojecten*. BH6947. Amersfoort, the Netherlands, 2021. url: https://www.rvo.nl/sites/default/files/2021/07/Verbeteren_netinpassing_zonne_energieprojecten_10_toepassingen_in_kaart_gebracht_DEFINITIEF.pdf.
- [55] Netbeheer Nederland, *Basisinformatie over energie-infrastructuur*. The Hague, the Netherlands, 2019. url: https://www.netbeheernederland.nl/_upload/Files/Basisdocument_over_energie_infrastructuur_143.pdf.
- [56] Cohen, J., Moeltner, K., Reichl, J., Schmidthaler, M., “An Empirical Analysis of Local Opposition to New Transmission Lines Across the EU-27.” In: *The Energy Journal* 37.3 (2016). issn: 01956574. doi: 10.5547/01956574.37.3.jcoh. url: <http://www.iaee.org/en/publications/ejarticle.aspx?id=2777>.
- [57] Netbeheer Nederland, *Capaciteitskaart invoeding elektriciteitsnet*. 2022. url: <https://capaciteitskaart.netbeheernederland.nl>.
- [58] Sovacool, B. K., Watts, C., “Going Completely Renewable: Is It Possible (Let Alone Desirable)?” In: *The Electricity Journal* 22.4 (2009), pp. 95–111. issn: 1040-6190. doi: 10.1016/j.tej.2009.03.011. url: <https://www.sciencedirect.com/science/article/pii/S1040619009000712> (visited on 12/06/2021).
- [59] Moriarty, P., Honnery, D., “Feasibility of a 100% Global Renewable Energy System.” In: *Energies* 13.21 (2020). Number: 21 Publisher: Multidisciplinary Digital Publishing Institute, p. 5543. doi: 10.3390/en13215543. url: <https://www.mdpi.com/1996-1073/13/21/5543> (visited on 12/06/2021).
- [60] Delucchi, M. A., Jacobson, M. Z., “Providing all global energy with wind, water, and solar power, Part II: Reliability, system and transmission costs, and policies.” In: *Energy Policy* 39.3 (2011), pp. 1170–1190. issn: 0301-4215. doi: 10.1016/j.enpol.2010.11.045. url: <https://www.sciencedirect.com/science/article/pii/S0301421510008694> (visited on 12/02/2021).
- [61] Jacobson, M. Z., Delucchi, M. A., “Providing all global energy with wind, water, and solar power, Part I: Technologies, energy resources, quantities and areas of infrastructure, and materials.” In: *Energy Policy* 39.3 (2011), pp. 1154–1169. issn: 0301-4215. doi: 10.1016/j.enpol.2010.11.040. url: <https://www.sciencedirect.com/science/article/pii/S0301421510008645> (visited on 12/02/2021).
- [62] Jacobson, M. Z., Delucchi, M. A., Cameron, M. A., Frew, B. A., “Low-cost solution to the grid reliability problem with 100% penetration of intermittent wind, water, and solar for all purposes.” In: *Proceedings of the National Academy of Sciences* 112.49 (2015). Publisher: National Academy of Sciences Section: Physical Sciences, pp. 15060–15065. issn: 0027-8424, 1091-6490. doi: 10.1073/pnas.1510028112. url: <https://www.pnas.org/content/112/49/15060> (visited on 12/06/2021).

- [63] Jacobson, M. Z. “100% Clean and Renewable Wind, Water, and Sunlight All-Sector Energy Roadmaps for 139 Countries of the World.” In: *Joule* 1.1 (2017), pp. 108–121. ISSN: 2542-4351. DOI: 10.1016/j.joule.2017.07.005. URL: <https://www.sciencedirect.com/science/article/pii/S2542435117300120> (visited on 12/06/2021).
- [64] Li, B., Basu, S., Watson, S. J., Russchenberg, H. W. J., “A Brief Climatology of Dunkelflaute Events over and Surrounding the North and Baltic Sea Areas.” In: *Energies* 14.20 (2021), p. 6508. ISSN: 1996-1073. DOI: 10.3390/en14206508. URL: <https://www.mdpi.com/1996-1073/14/20/6508> (visited on 12/06/2021).
- [65] Trainer, T. “A critique of Jacobson and Delucchi’s proposals for a world renewable energy supply.” In: *Energy Policy* 44 (2012), pp. 476–481. ISSN: 03014215. DOI: 10.1016/j.enpol.2011.09.037. URL: <https://linkinghub.elsevier.com/retrieve/pii/S0301421511007269> (visited on 12/06/2021).
- [66] Delucchi, M. A., Jacobson, M. Z., “Response to “A critique of Jacobson and Delucchi’s proposals for a world renewable energy supply” by Ted Trainer.” In: *Energy Policy* 44 (2012), pp. 482–484. ISSN: 03014215. DOI: 10.1016/j.enpol.2011.10.058. URL: <https://linkinghub.elsevier.com/retrieve/pii/S0301421511008731> (visited on 12/06/2021).
- [67] Trainer, T. “100% Renewable supply? Comments on the reply by Jacobson and Delucchi to the critique by Trainer.” In: *Energy Policy* 57 (2013), pp. 634–640. ISSN: 0301-4215. DOI: 10.1016/j.enpol.2012.10.007. URL: <https://www.sciencedirect.com/science/article/pii/S0301421512008658> (visited on 12/06/2021).
- [68] Hart, E. K., Stoutenburg, E. D., Jacobson, M. Z., “The Potential of Intermittent Renewables to Meet Electric Power Demand: Current Methods and Emerging Analytical Techniques.” In: *Proceedings of the IEEE* 100.2 (2012). Conference Name: Proceedings of the IEEE, pp. 322–334. ISSN: 1558-2256. DOI: 10.1109/JPROC.2011.2144951.
- [69] Elliston, B., MacGill, I., Diesendorf, M., “Least cost 100% renewable electricity scenarios in the Australian National Electricity Market.” In: *Energy Policy* 59 (2013), pp. 270–282. ISSN: 0301-4215. DOI: 10.1016/j.enpol.2013.03.038. URL: <https://www.sciencedirect.com/science/article/pii/S0301421513002164> (visited on 12/07/2021).
- [70] Schädler, Y., Renken, V., Sorg, M., Gerdes, L., Gerdes, G., Fischer, A., “Power transport needs for the German power grid for a major demand coverage by wind and solar power.” In: *Energy Strategy Reviews* 34 (2021), p. 100626. ISSN: 2211-467X. DOI: 10.1016/j.esr.2021.100626. URL: <https://www.sciencedirect.com/science/article/pii/S2211467X21000122> (visited on 10/26/2021).
- [71] Loftus, P. J., Cohen, A. M., Long, J. C. S., Jenkins, J. D., “A critical review of global decarbonization scenarios: what do they tell us about feasibility?” In: *Wiley Interdisciplinary Reviews Climate Change* 6.1 (2015), pp. 93–112. ISSN: 1757-7799. DOI: 10.1002/wcc.324. URL: <https://onlinelibrary.wiley.com/doi/abs/10.1002/wcc.324> (visited on 12/06/2021).
- [72] Heard, B. P., Brook, B. W., Wigley, T. M. L., Bradshaw, C. J. A., “Burden of proof: A comprehensive review of the feasibility of 100% renewable-electricity systems.” In: *Renewable and Sustainable Energy Reviews* 76 (2017), pp. 1122–1133. ISSN: 1364-0321. DOI: 10.1016/j.rser.2017.03.114. URL: <https://www.sciencedirect.com/science/article/pii/S1364032117304495> (visited on 12/07/2021).
- [73] Rodríguez, R. A., Becker, S., Andresen, G. B., Heide, D., Greiner, M., “Transmission needs across a fully renewable European power system.” In: *Renewable Energy* 63 (2014), pp. 467–476. ISSN: 0960-1481. DOI: 10.1016/j.renene.2013.10.005. URL: <https://www.sciencedirect.com/science/article/pii/S0960148113005351> (visited on 12/07/2021).
- [74] Becker, S., Rodríguez, R. A., Andresen, G. B., Schramm, S., Greiner, M., “Transmission grid extensions during the build-up of a fully renewable pan-European electricity supply.” In: *Energy* 64 (2014), pp. 404–418. ISSN: 0360-5442. DOI: 10.1016/j.energy.2013.10.010. URL: <https://www.sciencedirect.com/science/article/pii/S0360544213008438> (visited on 12/07/2021).
- [75] ENTSO-E, *Indicative values for Net Transfer Capacities (NTC) in Continental Europe: Winter 2010/11, working day, peak hours (non-binding values)*. ENTSO-E, 2011. URL: <https://eepublicdownloads.entsoe.eu/clean-documents/pre2015/ntc/archive/NTC-Values-Winter-2010-2011.pdf> (visited on 12/09/2021).
- [76] Vovk, A. *Completing the map – Power system needs in 2030 and 2040*. Brussels, Belgium: ENTSO-E, 2021. URL: <https://tyndp.entsoe.eu/system-needs/>.

- [77] Zappa, W., Junginger, M., Broek, M., “Is a 100% renewable European power system feasible by 2050?” In: *Applied Energy* 233-234 (2019), pp. 1027–1050. issn: 0306-2619. doi: 10.1016/j.apenergy.2018.08.109. url: <https://www.sciencedirect.com/science/article/pii/S0306261918312790> (visited on 12/14/2021).
- [78] Birnie, D. P. “Solar-to-vehicle (S2V) systems for powering commuters of the future.” In: *Journal of Power Sources* 186.2 (2009), pp. 539–542. issn: 03787753. doi: 10.1016/j.jpowsour.2008.09.118. url: <http://linkinghub.elsevier.com/retrieve/pii/S0378775308018946>.
- [79] Neumann, H.-M., Schär, D., Baumgartner, F., “The potential of photovoltaic carports to cover the energy demand of road passenger transport.” In: *Progress in Photovoltaics: Research and Applications* 20.6 (2012), pp. 639–649. issn: 1099-159X. doi: 10.1002/pip.1199. url: <https://onlinelibrary.wiley.com/doi/abs/10.1002/pip.1199>.
- [80] Denholm, P., Kuss, M., Margolis, R. M., “Co-benefits of large scale plug-in hybrid electric vehicle and solar PV deployment.” In: *Journal of Power Sources* 236 (2013), pp. 350–356. issn: 03787753. doi: 10.1016/j.jpowsour.2012.10.007. url: <http://linkinghub.elsevier.com/retrieve/pii/S0378775312015534>.
- [81] Tong, S. J., Same, A., Kootstra, M. A., Park, J. W., “Off-grid photovoltaic vehicle charge using second life lithium batteries: An experimental and numerical investigation.” In: *Applied Energy* 104 (2013), pp. 740–750. issn: 0306-2619. doi: 10.1016/j.apenergy.2012.11.046. url: <http://www.sciencedirect.com/science/article/pii/S0306261912008495>.
- [82] Goldin, E., Erickson, L., Natarajan, B., Brase, G., Pahwa, A., “Solar powered charge stations for electric vehicles.” In: *Environmental Progress & Sustainable Energy* 33.4 (2014), pp. 1298–1308. issn: 1944-7450. doi: 10.1002/ep.11898. url: <http://onlinelibrary.wiley.com/doi/abs/10.1002/ep.11898>.
- [83] Erickson, L. E., Burkey, A., Morrissey, K. G., Reynolds, M., Robinson, J., Ronnebaum, B., Wagner, T., Singh, P., Natarajan, B., Pahwa, A., “Social, economic, technological, and environmental impacts of the development and implementation of solar-powered charge stations.” In: *Environmental Progress & Sustainable Energy* 34.6 (2015), pp. 1808–1813. issn: 1944-7450. doi: 10.1002/ep.12163. url: <http://onlinelibrary.wiley.com/doi/abs/10.1002/ep.12163>.
- [84] Ma, T., Mohammed, O. A., “Optimal Charging of Plug-in Electric Vehicles for a Car-Park Infrastructure.” In: *IEEE Transactions on Industry Applications* 50.4 (2014), pp. 2323–2330. issn: 0093-9994, 1939-9367. doi: 10.1109/TIA.2013.2296620. url: <http://ieeexplore.ieee.org/document/6697868/>.
- [85] Kam, M., Sark, W., “Smart charging of electric vehicles with photovoltaic power and vehicle-to-grid technology in a microgrid; a case study.” In: *Applied Energy* 152 (2015), pp. 20–30. issn: 03062619. doi: 10.1016/j.apenergy.2015.04.092. url: <http://linkinghub.elsevier.com/retrieve/pii/S0306261915005553>.
- [86] Bhatti, A. R., Salam, Z., Aziz, M. J. B. A., Yee, K. P., Ashique, R. H., “Electric vehicles charging using photovoltaic: Status and technological review.” In: *Renewable and Sustainable Energy Reviews* 54 (2016), pp. 34–47. issn: 1364-0321. doi: 10.1016/j.rser.2015.09.091. url: <http://www.sciencedirect.com/science/article/pii/S1364032115010618>.
- [87] Nunes, P., Figueiredo, R., Brito, M. C., “The use of parking lots to solar-charge electric vehicles.” In: *Renewable and Sustainable Energy Reviews* 66 (2016), pp. 679–693. issn: 13640321. doi: 10.1016/j.rser.2016.08.015. url: <http://linkinghub.elsevier.com/retrieve/pii/S1364032116304294>.
- [88] Figueiredo, R., Nunes, P., Brito, M. C., “The feasibility of solar parking lots for electric vehicles.” In: *Energy* 140 (2017), pp. 1182–1197. issn: 03605442. doi: 10.1016/j.energy.2017.09.024. url: <http://linkinghub.elsevier.com/retrieve/pii/S0360544217315438>.
- [89] Chandra Mouli, G. “Charging electric vehicles from solar energy: Power converter, charging algorithm and system design.” PhD thesis. Delft University of Technology, 2018. doi: 10.4233/uuid:dec62be4-d7cb-4345-a8ae-65152c78b80f. url: <http://resolver.tudelft.nl/uuid:dec62be4-d7cb-4345-a8ae-65152c78b80f>.
- [90] Chandra Mouli, G., Bauer, P., Zeman, M., “System design for a solar powered electric vehicle charging station for workplaces.” In: *Applied Energy* 168 (2016), pp. 434–443. issn: 03062619. doi: 10.1016/j.apenergy.2016.01.110. url: <http://linkinghub.elsevier.com/retrieve/pii/S0306261916300988>.
- [91] Meer, D. v. d., Mouli, G. R. C., Morales-Espana, G., Elizondo, L. R., Bauer, P., “Energy Management System with PV Power Forecast to Optimally Charge EVs at the Workplace.” In: *IEEE Transactions on Industrial Informatics* PP.99 (2016), pp. 1–1. issn: 1551-3203. doi: 10.1109/TII.2016.2634624.

- [92] Chandra Mouli, G. R., Schijffelen, J., Heuvel, M., Kardolus, M., Bauer, P., “A 10kW Solar-Powered Bidirectional EV Charger Compatible with Chademo and COMBO.” In: *IEEE Transactions on Power Electronics* PP.99 (2018). issn: 0885-8993. doi: 10.1109/TPEL.2018.2829211. URL: <https://repository.tudelft.nl/islandora/object/uuid%3A9af706ad-0eae-4cc2-af07-a7ce348b126b>.
- [93] Traube, J., Lu, F., Maksimovic, D., Mossoba, J., Kromer, M., Faill, P., Katz, S., Borowy, B., Nichols, S., Casey, L., “Mitigation of Solar Irradiance Intermittency in Photovoltaic Power Systems With Integrated Electric-Vehicle Charging Functionality.” In: *IEEE Transactions on Power Electronics* 28.6 (2013), pp. 3058–3067. issn: 1941-0107. doi: 10.1109/TPEL.2012.2217354.
- [94] Brinkel, N. B. G., Gerritsma, M. K., AlSkaif, T. A., Lampropoulos, I., Voorden, A. M., Fidder, H. A., Sark, W. G. J. H. M., “Impact of rapid PV fluctuations on power quality in the low-voltage grid and mitigation strategies using electric vehicles.” In: *International Journal of Electrical Power & Energy Systems* 118 (2020), p. 105741. issn: 0142-0615. doi: 10.1016/j.ijepes.2019.105741. URL: <http://www.sciencedirect.com/science/article/pii/S0142061519319994>.
- [95] Math Bollen, Sarah Rönnberg, “Hosting Capacity of the Power Grid for Renewable Electricity Production and New Large Consumption Equipment.” In: *Energies* 10.9 (2017), p. 1325. issn: 1996-1073. doi: 10.3390/en10091325. URL: <http://www.mdpi.com/1996-1073/10/9/1325>.
- [96] Mouli, G. R. C., Leendertse, M., Prasanth, V., Bauer, P., Silvester, S., Geer, S. v. d., Zeman, M., “Economic and CO2 Emission Benefits of a Solar Powered Electric Vehicle Charging Station for Workplaces in the Netherlands.” In: *2016 IEEE Transportation Electrification Conference and Expo (ITEC)*. 2016 IEEE Transportation Electrification Conference and Expo (ITEC). Dearborn, MI, USA, 2016, pp. 1–7. doi: 10.1109/ITEC.2016.7520273.

OPTIMISED SCHEDULING OF EV CHARGING IN SOLAR PARKING LOTS

Abstract

Scheduled charging offers the potential for electric vehicles (EVs) to use renewable energy more efficiently, lowering costs and improving the stability of the electricity grid. Many studies related to EV charge scheduling found in the literature assume perfect or highly accurate knowledge of energy demand for EVs expected to arrive after the scheduling is performed. However, in practice, there is always a degree of uncertainty related to future EV charging demands. In this work, a Model Predictive Control (MPC) based scheduling strategy is developed, which takes this uncertainty into account, both in terms of the timing of the EV arrival as well as the magnitude of energy demand. The objective of the strategy is to reduce the peak electricity demand at an EV parking lot with PV arrays. The developed formulation is compared with both conventional EV charging as well as smart charging with an assumption of perfect knowledge of uncertain future events. The comparison reveals that forecasting EV demand over a 24 hour horizon has the effect of reducing the annual peak EV demand by 36%. Further, strategies that are able to robustly consider uncertainty across many possible forecasts can reduce the peak electricity demand by as much as 39% at an office parking space. The reduction of peak electricity demand can lead to increased flexibility for system design, planning for EV charging facilities, deferral or avoidance of the upgrade of grid capacity as well as its better utilisation.

This chapter is adapted from **Ghotge, R.**, Snow, Y., Farahani, S., Lukszo, Z., Wijk, A., “Optimized Scheduling of EV Charging in Solar Parking Lots for Local Peak Reduction under EV Demand Uncertainty.” In: *Energies* 13.5 (2020). Number: 5 Publisher: Multidisciplinary Digital Publishing Institute, p. 1275. ISSN: 1996-1073. DOI: 10.3390/en13051275

3.1 INTRODUCTION

The charging of the majority of EV on the road today is uncoordinated or unscheduled, which can cause increased peak electricity demand. As discussed earlier in this thesis, higher peak loads can lead to the need for additional peak power capacity as well as additional capacity in the distribution grid. Scheduled charging involves the ordering of EV charging events in time over a limited number of charge points. The mathematical formulation of these total number of charging sessions across a given time horizon can then be optimised to ensure that each individual charging session aligns with a stated objective.

Scheduled charging is discussed extensively in literature, analysing different systems from the perspective of different actors and with a range of objectives. These factors tend to determine the information required for the formulation of the problem. We focus in this chapter on scheduled charging to reduce peak loads at a solar carport. A brief overview of scheduled charging for peak reduction is presented below:

Clement-Nyns et al. [1] investigated the impact of EV charging on residential distribution grids in Belgium. EV charging arriving at an arbitrary time within a fixed time range are set to charge on a representative residential radial network. Unscheduled charging is found to lead to high power losses and voltage deviations during the evening residential peak between 6 pm and 9 pm. Scheduled charging is performed to minimise Ohmic losses in the network, which are proportional to the square of current. Although the household demands are forecasted stochastically, the arrival of other EVs over the considered horizon are not considered. The power demand of a single EV (4 kW) is considerably larger than the loads in the household profiles considered in the study and the energy required for a daily charging session is in the range of a household daily energy demand [2]. The lack of EV load forecasting is thus a considerable oversight—particularly from a peak shaving perspective.

Sortomme and El-Sharkawi [3] proposed the scheduling of a fleet of 10,000 V2G compatible EVs in Texas, USA. The aggregator profits through participation in various markets as well as lower cost of charging for vehicle drivers are then maximised. Although the formulation acknowledges and accounts for the unexpected departure of EVs, it assumes that the aggregator has accurate information on both the EV driving patterns as well as their SoCs, based on which demands are calculated.

In [4], EVs are scheduled for peak reduction and self-consumption within a microgrid. A car-sharing setup is considered, where the users reserve vehicles in advance for the trips they plan. In such a case, the deviation from the planned schedule is small, assumed to be always less than an hour. EVs that are not used in such a car-sharing scheme are not considered. Similarly, in [5], fuel cell electric vehicles are scheduled for V2G energy dispatch in a microgrid. However, although load forecasting is performed with an

assumption of accuracy, mobility-related uncertainty associated with the future arrival of vehicles remains unaddressed.

Neglect or incomplete consideration of future EV demand in these models can negatively influence EV scheduling strategies. When designing an optimal strategy, it is critical that uncertainty of vehicle charging demand (both in terms of timing as well as magnitude) is taken into account. This chapter investigates and quantifies the effect of this uncertainty. It is taken into consideration to develop strategies based on Model Predictive Control (MPC) for scheduling EV charging.

The chapter is divided into sections as follows: section 3.2 describes the physical system considered i.e., the solar parking lot, EVs and EVSE and its modeling. section 3.3 introduces the proposed methods of charge scheduling based on MPC methodology and their formulation. section 3.4 illustrates the results obtained from running the simulations and discusses their relevance. Finally, section 3.5 provides the conclusions together with interesting directions for future research.

3.2 SYSTEM DESCRIPTION

The system considered is a solar parking lot for the charging of electric vehicles as seen in Fig. 3.1. It includes a solar PV array, stationary storage and LED lighting connected to a DC bus, coupled bidirectionally with a grid-connected AC bus, which enables AC charging. The system was modeled in MATLAB and was used to generate inputs for the scheduling strategy.

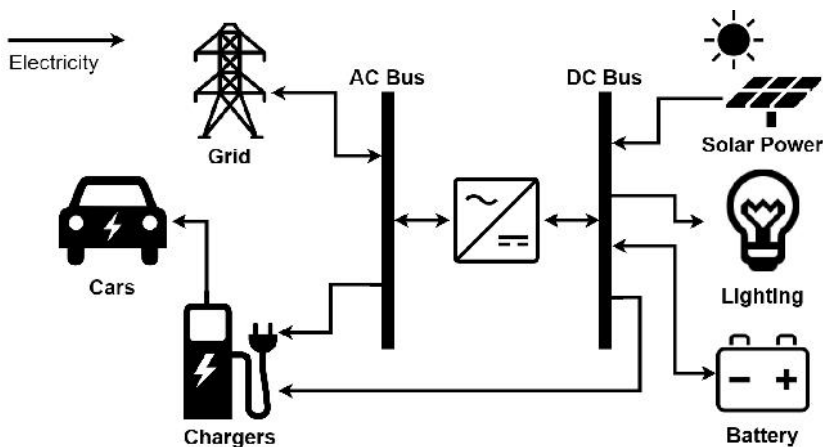

Figure 3.1: System configuration of a smart solar parking lot.

3.2.1 SOLAR CARPORTS

The parking lot considered included solar carports covering 40 parking spaces. The total solar PV array generation capacity was 120 kWp, corresponding to 3 kWp of generation per parking space. Power generation was simulated based on weather data from the Cabauw weather station located in the province of Utrecht in The Netherlands [6]. The data was used to simulate the typical power of the solar power array for one year with a time resolution of 15 min. Solar power generation was modeled using PVLlib, a validated open-source tool developed by Sandia National Labs [7]. Table 3.1 describes the solar PV array characteristics used in the model.

Table 3.1: Description of solar photovoltaic array characteristics.

Characteristic	Value
Module technology	Monocrystalline silicon
Module rated power	300 kWp (60 cell)
Module rated efficiency	18.33% at STC
Array installed capacity	120 kWp
Site location	51°58' N, 4°55' E
Array orientation	0 °(South), 13 °tilt
Parking spaces	40 spaces
Carport roof topology	Monopitch (single tilt angle for the entire roof)
Annual production (DC)	134 MWh
Capacity factor (DC)	12.7%

3.2.2 BATTERIES

The electric vehicle batteries using the parking lot for charging were assumed to be representative of the current Dutch EV fleet (as of 2018), including Battery Electric Vehicles (BEVs) and PHEVs. The battery energy capacities considered therefore range from the 8.8 kWh Audi A3 PHEV to the 100 kWh Tesla Model X BEV. The solar parking lot also included a stationary Li-ion based battery storage system, for storing excess energy to further reduce the peak demand. The battery had a rated power of 50 kW and a capacity of 50 kWh, of which 80% was usable. The total number of batteries,

N_b , is at all times less than 41, since the maximum occupancy of the parking lot is 40 EVs and there is always the stationary battery.

The charging efficiency, η_{chg} , and discharging efficiency, η_{dis} , in the battery, were each assumed to be 95%, leading to overall roundtrip losses of 9.75%. Coulomb counting was used to infer the SoC of the battery and changes to it. The rectification stage in the vehicle was assumed to lead to losses of about 6% in charging [8].

3.2.3 ELECTRIC VEHICLE SUPPLY EQUIPMENT

The system includes 40 charge points, each rated at 32 A (7.4 kW) for both AC and DC. While this rating is commonly found as AC level 2 charging [9], it is a lower current capacity than commercial DC charge points. The reason for this choice was to enable the slow charging of EV batteries on the DC bus without multiple rectification-inversion stages, as is expected in the future. The losses in the EVSE, which are primarily resistive in nature, were assumed to be around 0.2% [8].

3.2.4 ELECTRIC VEHICLE LOAD PROFILE

The electric vehicle load profile was built based on two submodels: first, the EV arrival and departure model and second, the estimation of the state of charge at the point of entry. In addition, the load is also determined by the extent to which the battery is to be charged by the time of departure. In this work, it is assumed that the EV drivers wish for their EVs to be charged to 100% SoC whenever possible.

3.2.4.1 *EV arrival and departure*

Direct Use of Observed Activity-Travel Schedule (DUOATS) models are a common method applied in smart charging and demand response studies [10]. Such a model was used in this work, whereby observed vehicle patterns were used to simulate EV behavior. The parking location considered was a workplace, and the model was based on data from the EV Project, a project run by the United States Department of Energy. It included data related to 8228 electric vehicles and hundreds of thousands of trips and charging events [11]. Since the data was collected from a large number of participants and geographical locations across the USA, it was assumed to be generalisable.

This historical parking data was used to determine the arrival and departure rates at both parking lots for each time step of the day, considering weekdays and weekends separately. Based on these rates, a Monte Carlo approach was taken to determine the number of EV arrivals in each time step. The duration of parking and the time of day were used to determine the number of departures in each time step, after which an occupancy profile

was built. A representative week of occupancy of vehicles at the workplace is shown in Fig. 3.2. There are noticeable daily patterns of arrivals and departures during weekdays, with weekends having lower arrival rates.

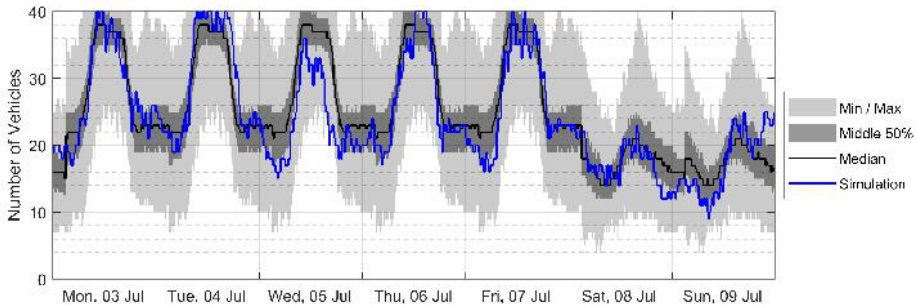

Figure 3.2: Simulated occupancy at the workplace parking lot over a week.

3.2.4.2 *EV state of charge on arrival*

Truncated normal distributions were used for assigning the SoC on arrival. The coefficients for the normal distribution were inferred by fitting data from the EV Project [11], which collected data for over 8000 EVs in the USA. They are shown in Table 3.2.

Table 3.2: Coefficients describing the assignment of EV battery states of charge on arrival.

EV Type	Mean	Standard Deviation	Lower Bound	Upper Bound
BEV	50%	18%	0%	90%
PHEV	45%	30%	0%	90%

The lower mean SoC and greater standard deviation for PHEV are explained by the lower concern of PHEV drivers about depleted batteries in comparison with BEVs drivers.

Based on the time of arrival of an individual EV, the battery capacity of the EV and its SoC at the time of arrival, the expected charging demand of the EV was calculated. This demand (or as high a fraction as possible) needed to be met within the plug-in duration. The control system was informed about the time of departure at the time of arrival in all cases.

With knowledge of the available solar energy, the forecasted solar energy over the forecast horizon and the EV charging demand, the optimal charging of EVs in the parking space was to be determined in a manner that minimised the peak electricity

demand in the solar parking lot. The following section describes the methods used for this scheduling.

3.3 METHODS FOR EV CHARGE SCHEDULING

For an investigation into the effect of uncertainty of EV demand on peak loads, two reference cases and three scenarios are considered. One reference case is unscheduled charging, where EVs charge at maximum power as soon as they are plugged in. In addition, a case is simulated with perfect forecasting of solar production and EV demand, which may be considered as another reference case. The three scenarios investigated lie between these two reference cases:

1. *No EV demand forecast*: EV charging is scheduled without a forecast of energy demand for EVs arriving in the future
2. *Average EV demand forecast*: EV charging is scheduled with a single forecast of energy demand for EVs arriving in the future which is based on average historic values.
3. *Robust EV demand forecast*: EV charging is scheduled to be robust across a range of possible energy demands for EVs arriving in the future

In all these three scenarios, the schedule was designed to be robust across a range of possible solar forecasts. These scenarios thus differ only in their approach to EV demand forecasting. The objective function for peak reduction under perfectly accurate forecasts is described in section 3.3.1. The introduction of uncertainty in the forecasts is described in section 3.3.2, after which each of the three scenarios and their respective formulations are described. The commercial solver, Gurobi, was used with MATLAB in each case on a Windows PC with an Intel i5 1600 MHz quad-core processor and 32 GB RAM.

3.3.1 PROBLEM FORMULATION WITH PERFECT FORECASTING

In the scenario with perfect forecasting, the future solar production, as well as future electric vehicle demand over the 24 hour horizon in the future, are assumed to be accurately known in advance. This is not a practically feasible scenario since neither of these can be accurately known or predicted. However, this scenario clearly defines the best possible performance of the scheduling approach, with reference to which other scenarios may be compared. In addition, it also provides an idea of the performance of the scheduling algorithm independent of the degree of accuracy of the forecast.

To optimise the scheduling of EVs within the carport, we apply MPC. MPC is a control technique used for determining the optimal behavior of complex multivariate

problems. The control action is determined at each time step by solving an open-loop optimal control problem over a finite time horizon. MPC is used to solve problems during the operation of the system, taking the state of the system into account at each time step. These characteristics make MPC suitable for the control of EV charge scheduling at the solar parking lot.

The goal of the scheduling of EV charging is to reduce the peak demand of the solar parking lot over the time horizon under consideration. Thus, the objective function is:

$$\text{minimise } \max(E_{grid}(k), \dots, E_{grid}(k + N_p - 1)), \quad (3.1)$$

where $E_{grid}(k)$ is the net energy exchange between the parking lot and the grid at time k and N_p is the time horizon, which is 24 hours. A sensitivity analysis on the duration of the horizon revealed that longer forecasts had no increased benefits to the simulation. Further, with reduction in the accuracy of the length of the forecasting horizon, the reliability of longer horizon forecasts is lower upon the introduction of forecasting uncertainty. An auxiliary variable, $E_{grid}^{max}(t)$ is introduced, which represents the local maxima or peak in grid exchange of the parking lot with N_b batteries and lighting load, E_{load} over the considered horizon, N_p .

The objective function is thus rewritten as:

$$\text{minimise } E_{grid}^{max} \quad (3.2)$$

$E_{grid}^{max}, E, \delta, z$

with the decision variables

$$E_{grid}^{max}, E_i(t), \delta_i(t), z_i(t) \quad \text{for } i \in \{1, \dots, N_b\}, \quad t \in \{k, \dots, k + N_p - 1\}, \quad (3.3)$$

subject to a number of constraints, described below.

At any given time, t , the energy exchanged with the grid, $E_{grid}(t)$, depends on the PV production, $E_{PV}(t)$, the lighting load, $E_{load}(t)$, and summed load of each battery, $E(t)$. It is ensured that the energy exchange peak, which is subject to minimisation, is the highest peak within the considered horizon both in purchase as

$$E_{grid}^{max} \geq E_{load}(t) - E_{PV}(t) + \sum_{i=1}^{N_b} E_i(t) \quad \forall t, \quad (3.4)$$

as well as in feed in as

$$E_{grid}^{min} \leq E_{load}(t) - E_{PV}(t) + \sum_{i=1}^{N_b} E_i(t) \quad \forall t. \quad (3.5)$$

The stored energy in the i^{th} battery in the $(k + 1)^{th}$ time step, the state variable, $S_i(k + 1)$, is described as

$$S_i(k + 1) = \begin{cases} S_i(k) + \eta_{chg,i} \cdot E_i(k), & E_i(k) > 0 \\ S_i(k) + \frac{1}{\eta_{dis,i}} E_i(k), & E_i(k) \leq 0 \end{cases}. \quad (3.6)$$

In order to formulate the battery behavior linearly, the Mixed Logical Dynamics (MLD) formalism is used [12]. A binary decision variable $\delta_i(t)$ is introduced, defined as:

$$[\delta_i(t) = 0] \leftrightarrow [E_i(t) > 0] \text{ (EV or battery is charging)} \quad (3.7)$$

$$[\delta_i(t) = 1] \leftrightarrow [E_i(t) \leq 0] \text{ (battery is discharging)}, \quad (3.8)$$

and leads to the constraint:

$$\delta_i(t) \in \{0, 1\} \quad \forall i, t. \quad (3.9)$$

This binary decision variable, $\delta_i(t)$, is then used to reformulate Eq. eq. (3.6) as

$$S_i(k + 1) = S_i(k) + \eta_{chg,i} \cdot E_i(k) \cdot (1 - \delta_i(k)) + \frac{1}{\eta_{dis,i}} E_i(k) \cdot \delta_i(k). \quad (3.10)$$

However, this formulation is still nonlinear because it contains the product of two decision variables, $E_i(k)$ and $\delta_i(k)$. An additional set of continuous decision variables is introduced as

$$z_i(t) = \delta_i(t) \cdot E_i(t). \quad (3.11)$$

The minimum energy, which can be stored in the i^{th} , battery in the $(t + 1)^{th}$ time step, is limited by the lowest possible energy which can be delivered to it with the objective of maximimising the SoC at departure. This is formulated as

$$S_i^{\min}(t + 1) \leq S_i(t) + \eta_{chg,i} E_i(t) + \left(\frac{1}{\eta_{dis,i}} - \eta_{chg,i} \right) z_i(t) \quad \forall i, t. \quad (3.12)$$

The maximum energy which can be stored in the i -th, battery in the $(t + 1)^{th}$ time step is limited by the physical constraints on the battery capacity and the power rating of the charge points. It is formulated as

$$S_i^{\max}(t + 1) \geq S_i(t) + \eta_{chg,i} E_i(t) + \left(\frac{1}{\eta_{dis,i}} - \eta_{chg,i} \right) z_i(t) \quad \forall i, t. \quad (3.13)$$

The constraints on the energy exchanged with the i^{th} battery in each time step is given as

$$E_i(t) \leq M_i \cdot (1 - \delta_i(t)) \quad \forall i, t \quad (3.14)$$

$$E_i(t) \geq \varepsilon + (m_i - \varepsilon) \cdot \delta_i(t) \quad \forall i, t, \quad (3.15)$$

where M_i is the maximum allowable value of $E_i(t)$ and m_i is the minimum allowable value. An overestimate of M_i or an underestimate of m_i is acceptable, but values close to the true maximum and minimum are preferred to lower computational time. These values are taken as

$$M_i = P_i^{max} \cdot \Delta t \quad (3.16)$$

$$m_i = -P_i^{max} \cdot \Delta t, \quad (3.17)$$

where P_i^{max} and P_i^{min} are the power limits of the i^{th} battery and Δt is the length of the time step i.e., 15 min. The tolerance, ε is a small value, typically the machine precision of the solver.

The following constraints then limit the auxiliary MLD variables $\delta_i(t)$ and $z_i(t)$ to ensure they will be equivalent to their stated definitions [12]

$$z_i(t) \leq M_i \cdot \delta_i(t) \quad \forall i, t \quad (3.18)$$

$$z_i(t) \geq m_i \cdot \delta_i(t) \quad \forall i, t \quad (3.19)$$

$$z_i(t) \leq E_i(t) + M_i \cdot (1 - \delta_i(t)) \quad \forall i, t \quad (3.20)$$

$$z_i(t) \geq E_i(t) + m_i \cdot (1 - \delta_i(t)) \quad \forall i, t. \quad (3.21)$$

3.3.2 INCLUSION OF UNCERTAINTY IN FORECASTING

Since historic data of the PV yield and modeled data for the EV demand were used, the values of the future PV yield and EV demand were known. In order to simulate an inaccurate forecast, errors were introduced to the known PV production and the EV demand over the relevant horizon.

3.3.2.1 Uncertainty in PV forecasting

$E_{PV}(t)$ is known to be the PV production over the relevant horizon at the time step, t . The forecasted value of PV production is the sum of $\bar{E}_{PV}(t)$ and an additional solar forecasting error term, $\omega_{PV}(t)$, as

$$E_{fcst}(t) = \bar{E}_{PV}(t) + \omega_{PV}(t). \quad (3.22)$$

Monte Carlo methods are used in this case to generate a finite but large number of error vectors, Ω_{PV}^* , which are then considered.

$$\Omega_{PV}^* = \{\omega_{PV}^{(1)}, \dots, \omega_{PV}^{(N_e)}\} \subseteq \Omega_{PV}, \quad (3.23)$$

where N_e is the number of error vectors considered. If N_e is large enough, Ω_{PV}^* may be considered to be a reasonably good approximation of Ω_{PV} , the set of all possible error

vectors. 10,000 is chosen for N_e in this case. Though forecasting error is normally distributed, for robust optimisation, a bounded distribution is required. The distribution is therefore truncated such that

$$-3\sigma_{PV}(t) \leq \omega_{PV}^j \leq 3\sigma_{PV}(t), \quad (3.24)$$

for all t in $k, \dots, k + N_P - 1$ and j in $1, \dots, N_e$. The upper and lower bounds are determined by $\sigma_{PV}(t)$ the standard deviation of the forecasting error at time, t . The forecasting error is also truncated so that the forecasted power generation cannot be less than zero or greater than the clear sky generation. The choice of three standard deviations as a limit, rather than more conservative values of five or seven, is justified based on simulation results.

3.3.2.2 Uncertainty in EV forecasting

Two approaches were considered here: the average approach and the Monte Carlo approach, as used in the PV uncertainty introduction. In the average approach, the terms S_i^{\min} and S_i^{\max} , defined in Eq. (3.12) and eq. (3.13) are taken to be their average values based on data collected from EVs in the parking lot at the time step, t . Thus, uncertainty in a number of variables like arrival time and numbers, departure times, the energy capacity of the vehicle, the SoC of the vehicle on arrival are all clustered together to be dealt with through the optimisation formulation. The nature of the formulation implies a single forecast is available in each time step, which is based upon average values in the past, thus satisfying the aim of this method of introduction of uncertainty.

In the second approach, error terms are introduced through Monte Carlo simulation, as with the errors in PV generation forecasts. However, as in the average case, the errors are introduced in the terms S_i^{\min} and S_i^{\max} , influencing the state constraints rather than the state variables. This formulation thus considers a range of possible forecasts, treated as equally probable, over which the problem needs to be solved.

3.3.3 NO EV DEMAND FORECAST

No EV forecasting is the simplest strategy where the charging of EVs plugged-in at the parking lot at the current time step are optimised over the period they are expected to be plugged in. The arrival of additional EVs in the near future and their demands are not considered: a drawback of the approach.

The schedule is designed to deal with uncertainty in the PV forecast. It does this by considering a range of possible PV forecasts, over all of which it reduces peaks. In other words, it operates robustly over a range of PV uncertainties.

To ensure robustness, we use min-max optimisation, which minimises the cost function over the decision variables for the worst case i.e., highest peak load. In this case, the objective function is

$$\underset{E_{grid}^{max}, E_i(t), \delta_i(t), z_i(t)}{\text{minimise}} \quad \underset{\omega \in \Omega_{PV}(t)}{\text{maximise}} \quad E_{grid}^{max} \quad (3.25)$$

where ω is a vector representing a random possible value for the forecasting errors at each time step t , and $\Omega_{PV}(t)$ is the bounded set of all possible forecasting errors. The errors at each time step are therefore drawn randomly from the uniform distribution given by

$$\omega_{PV}^j(t) \in \mathcal{U}(-3\sigma_{PV}(t), 3\sigma_{PV}(t)). \quad (3.26)$$

A new auxiliary variable, T , is now defined as the maximum value for the objective function under all the forecasting errors considered. Because the objective function is not directly dependant on the forecasting uncertainty, T can simply be defined as being equal to the original objective function. If J is the maximum peak in each case of forecasting error considered, and \tilde{u} the decision variables, T is given by

$$T = \max_{\tilde{u}} (J(\omega_{PV}^{(1)}), \dots, J(\omega_{PV}^{(N_e)})) = E_{grid}^{max} \quad (3.27)$$

where E_{grid}^{max} is independent of the uncertainty variables.

The objective function is redefined as

$$\underset{T, E_{grid}^{max}, E, \delta, z}{\text{minimise}} \quad T, \quad (3.28)$$

with the decision variables:

$$T E_i(t), \delta_i(t), z_i(t) \quad \text{for } i \in \{1, \dots, N_b\}, \quad t \in \{k, \dots, k + N_p - 1\}. \quad (3.29)$$

The constraints in Equations eq. (3.4) and eq. (3.5) are changed to include the solar forecasting error as

$$E_{grid}^{max} \geq E_{load}(t) - E_{fcst}(t) + \omega_{PV}^{max}(t) + \sum_{i=1}^{N_b} E_i(t) \quad \forall i, t \quad (3.30)$$

$$E_{grid}^{min} \leq E_{load}(t) - E_{fcst}(t) + \omega_{PV}^{min}(t) + \sum_{i=1}^{N_b} E_i(t) \quad \forall i, t \quad (3.31)$$

The optimisation problem is then solved to be robust across the errors in PV forecast, $\omega_{PV}(t)$, which lie within the bounded range of uncertainty $\Omega_{PV}(t)$. As proven in [12], a constraint cannot be active at some intermediate value of the disturbance without violating the constraint at the extreme value. In this model, the greater-than constraint will be active

only at the maximum value of the disturbance and a less-than constraint will be active only at the minimum. Hence, only the minimum value, $\omega_{PV}^{min}(t)$, and maximum value, $\omega_{PV}^{max}(t)$, of the errors were considered, which are sufficient for the all intermediate error values.

Although there is no EV forecasting, vehicles which are not plugged in at the charging station at the relevant time step, would still begin charging at some point in the future. These limits are then included in constraints in Eq. eq. (3.12) and eq. (3.13), which are modified to

$$S_i^{min}(t+1) \begin{cases} = 0, & \text{when a vehicle is not present at the current} \\ & \text{time step, } t, \text{ in space, } i \\ \leq S_i(t) + \eta_{chg,i}E_i(t) + \left(\frac{1}{\eta_{dis,i}} - \eta_{chg,i}\right) z_i(t) \quad \forall i, t \\ & \text{when a vehicle is present at the current} \\ & \text{time step, } t, \text{ in space, } i \end{cases} \quad (3.32)$$

and

$$S_i^{max}(t) \begin{cases} = 0, & \text{when a vehicle is not present at the current} \\ & \text{time step, } t, \text{ in space, } i \\ \geq S_i(t) + \eta_{chg,i}E_i(t) + \left(\frac{1}{\eta_{dis,i}} - \eta_{chg,i}\right) z_i(t) \quad \forall i, t \\ & \text{when a vehicle is present at the current} \\ & \text{time step, } t, \text{ in space, } i \end{cases} \quad (3.33)$$

The constraints in Eq. eq. (3.15) through Eq. eq. (3.21) remain unchanged.

3.3.4 AVERAGE EV DEMAND FORECAST

The objective function with robust solar PV forecast and a single average EV forecast remains the same as in Eq. eq. (3.28). The stored energy terms, $S_i^{min}(t)$ and $S_i^{max}(t)$ in the constraints in Eq. eq. (3.12) and eq. (3.13) are replaced by average values of these variables. The new constraints are therefore:

$$\overline{S_i^{min}(t+1)} \leq \overline{S_i(t)} + \eta_{chg,i}E_i(t) + \left(\frac{1}{\eta_{dis,i}} - \eta_{chg,i}\right) z_i(t) \quad \forall i, t \quad (3.34)$$

$$\overline{S_i^{max}(t+1)} \geq \overline{S_i(t)} + \eta_{chg,i}E_i(t) + \left(\frac{1}{\eta_{dis,i}} - \eta_{chg,i}\right) z_i(t) \quad \forall i, t, \quad (3.35)$$

where $\overline{S_i^{min}(t)}$ and $\overline{S_i^{max}(t)}$ are the average values for the variables $S_i^{min}(t)$ and $S_i^{max}(t)$ respectively.

3.3.5 ROBUST EV DEMAND FORECAST

The system is meant to be robust in the sense of reducing peak grid exchange across a wide range of EV forecasting errors as well as errors in the solar forecast. The maximum value, $\omega_i^{\max}(t)$ and minimum value, $\omega_i^{\min}(t)$, in the range of errors introduced in the EV demand forecast through the Monte Carlo simulation, as described in section 3.3.2.2, were used to define the state constraints for $S_i^{\min}(t)$ and $S_i^{\max}(t)$ as

$$S_i^{\min}(t) + \omega_i^{\max}(t) \leq S_i(t) + \eta_{chg,i}E_i(t) + \left(\frac{1}{\eta_{dis,i}} - \eta_{chg,i} \right) z_i(t) \quad (3.36)$$

$$S_i^{\min}(t) + \omega_i^{\min}(t) \geq S_i(t) + \eta_{chg,i}E_i(t) + \left(\frac{1}{\eta_{dis,i}} - \eta_{chg,i} \right) z_i(t). \quad (3.37)$$

However, constraints risk making the problem infeasible if $\omega_i^{\max}(t) > \omega_i^{\min}(t)$, which is highly likely. In order to enable a feasible solution to the problem, the state constraints for vehicles which are forecasted to arrive, are expressed as soft constraints:

$$S_i^{\min}(t) + \omega_i^{\max}(t) \leq S_i(t) + \eta_{chg,i}E_i(t) + \left(\frac{1}{\eta_{dis,i}} - \eta_{chg,i} \right) z_i(t) + \epsilon_i^1(t) \quad (3.38)$$

$$S_i^{\min}(t) + \omega_i^{\min}(t) \geq S_i(t) + \eta_{chg,i}E_i(t) + \left(\frac{1}{\eta_{dis,i}} - \eta_{chg,i} \right) z_i(t) - \epsilon_i^2(t). \quad (3.39)$$

for all $i \in \{1, \dots, N_b - 1\}$, $t \in \{k, \dots, k + N_p - 1\}$. The slack variables $\epsilon_i^1(t) \geq 0$ and $\epsilon_i^2(t) \geq 0$ correspond respectively to the constraints for the minimum and maximum stored energy, and are added to the optimisation problem as an auxiliary decision variables. For the stationary battery as well as the vehicles plugged in at the parking lot at a given time step, k , the state constraints remain hard since the minimum and maximum stored energies are known with certainty.

The complete optimisation formulation is then given by:

$$\underset{T, E_{grid}^{\max}, E, \delta, z, \epsilon}{\text{minimise}} \quad T + \frac{1}{(N_b - 1) \cdot N_p} \sum_{i=1}^{N_b-1} \sum_{t=k}^{k+N_p-1} c_1 \epsilon_i^1(t) + c_2 \epsilon_i^2(t), \quad (3.40)$$

where c_1 and c_2 are penalty constants. The values $c_1 = 1$ and $c_2 = 1$ were found empirically to lead to lowest values of peak demand. Increasing the penalty constant values did not however lead to large changes in peak demand. The decision variables are:

$$T, E_{grid}^{\max}, E_i(t), \delta_i(t), z_i(t), \epsilon_i^1(t), \epsilon_i^2(t) \text{ for } i \in \{1, \dots, N_b\}, \quad t \in \{k, \dots, k + N_p - 1\}, \quad (3.41)$$

with the additional constraint

$$\epsilon_i^1(t), \epsilon_i^2(t) \geq 0 \quad \forall i, t. \quad (3.42)$$

3.4 RESULTS AND DISCUSSION

A year of operation of the solar parking lot was simulated for each of the three described scenarios to determine the performance of the system at peak reduction in each case. During the comparison, the reference cases of unscheduled charging and perfect forecasts are also included to provide additional insights.

3.4.1 EXAMPLE SIMULATIONS

Fig. 3.3 shows the energy flows within the system over a representative period, in this case, a week. The two reference cases, unscheduled charging and charging with perfect forecasting, are compared. The characteristics of the scheduling seen here are also valid for longer simulations over the year.

In accordance with thermodynamic system conventions, the energy entering the electrical system (PV production, grid purchase and battery discharge) is taken as positive and energy leaving the system (EV and battery charging, lighting load and feed-in to the grid) as negative. The shape of the positive and negative sides are similar, showing the energy balance in each time step, excluding losses. The solar energy production is shown in yellow, battery charge and discharge in red and EV charging in blue. The lighting loads, which are very small in comparison with the others, are shown in green and residual grid load (after solar self-consumption and battery charge/discharge) in gray. The highest peak in the week is highlighted in each figure.

The largest peak in the residual grid load (110 kW) as a result of unscheduled charging, seen on Thursday in Fig. 3.3(a), is considerably reduced in magnitude to 50 kW as a result of scheduled charging with perfect forecasts, seen in Fig. 3.3(b). In addition, the frequency of these peaks is found to decrease considerably and a uniformly flat load profile achieved. The arrivals of many EVs on Tuesday, Wednesday and Thursday mornings, all of which lead to peaks in energy demand if unscheduled are all adequately shaved. Although the perfect forecasting scenario is not an applicable case, it demonstrates the success of the method at reducing the peak residual load in the week considered.

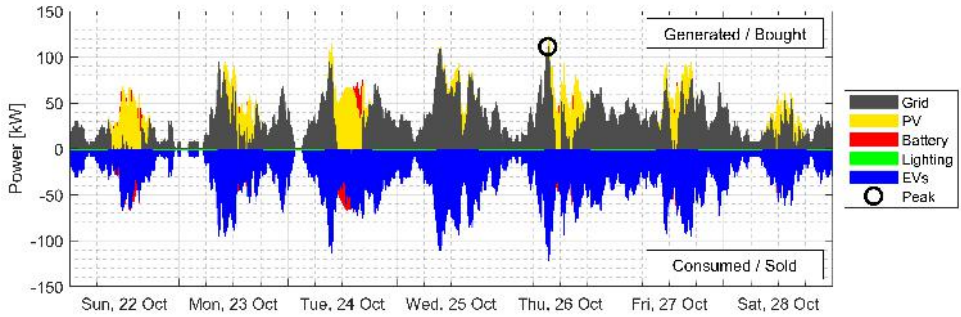

(a) Energy flows with unscheduled charging.

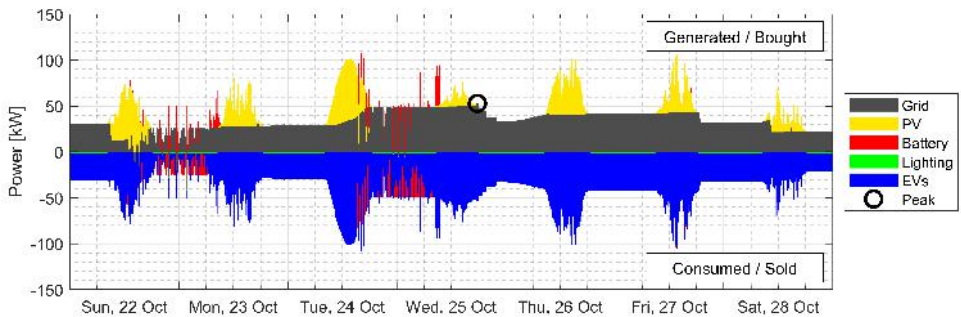

(b) Energy flows with perfect forecasting.

Figure 3.3: Comparison of energy flows in the solar parking lot with unscheduled charging as opposed to charging with perfect forecasts.

Fig. 3.4, similarly, shows the energy flows in the system for the three scenarios. As seen in Fig. 3.4(a), where no EV forecast is available, the magnitude of the highest peak in this case (100 kW) is lower than that in the unscheduled case. Relative to the perfectly forecasted case, though, the peaks are considerably higher. A drawback of the scenario can be seen in the situation leading to the Wednesday afternoon peak. The EVs in the parking lot on Tuesday night was charged slowly to reduce the peak load at night. This led to a larger number of vehicles in need of simultaneous charging on Wednesday morning, leading to a high peak in electricity demand in the afternoon. On the other hand, the Thursday peak seen in the unscheduled charging case was effectively shifted.

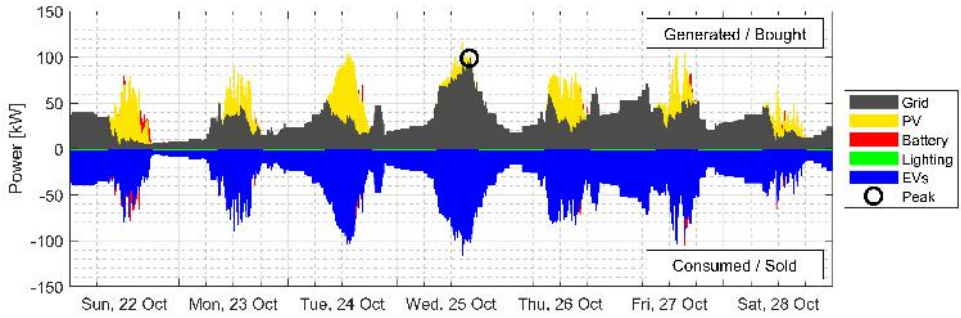

(a) Energy flows with no EV demand forecast.

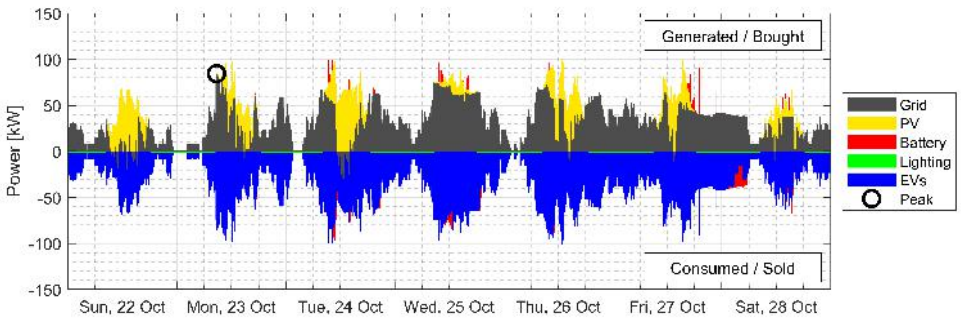

(b) Energy flows with average EV demand forecast.

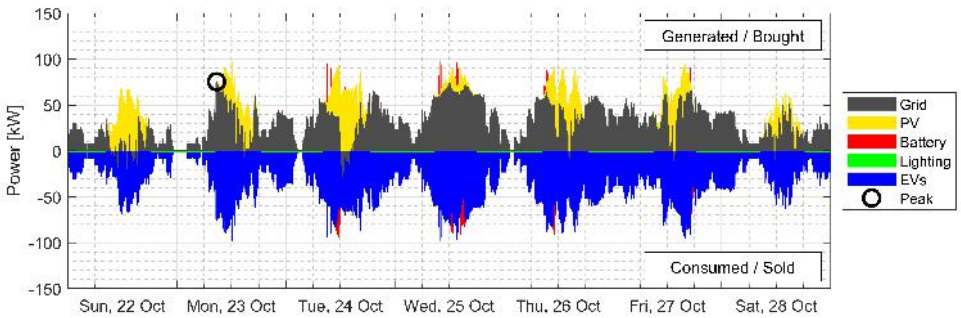

(c) Energy flows with robust EV demand forecast.

Figure 3.4: Comparison of energy flows in the solar parking lot with no EV demand forecast, a single average EV demand forecast and a robust consideration of EV demand forecasting.

The single average forecast seen in Fig. 3.4(b) already provides a considerable reduction in the magnitude of the highest peak (85 kW) relative to the case without an EV forecast. On the same Wednesday, the vehicles parked overnight are charged in the morning in anticipation of future arrivals, thus lowering the peak on Wednesday. However, a drawback of the system is seen on Monday, which has a lower than average EV charging demand. A large number of EVs are charged in the morning in anticipation of demand later in the day. However, the demand in the afternoon was lower than expected, making the morning peak unnecessary in hindsight. This leads to Monday having the highest peak in the week.

The robust treatment of forecasting seen in Fig. 3.4(c) results in even further reduction in the magnitude of the highest peak in the week, which is about 75 kW. The Wednesday load is lowered even more, and there is a better performance in the case of the lower demand on Monday. Similar to the average forecast, there are many peaks with similar magnitude across the week, but the height of the highest one is lower than in the case without the demand forecast.

In the system, the peak loads on the grid are always the result of EV charging and never the result of solar feed-in. While solar peaks did occur under low occupancy of the parking lot during summer when the stationary battery was full, they were generally lower than the EV charging peaks. Further, it was assumed that curtailment would be the strategy for peak shaving of solar feed-in peaks.

The power flows also reveal that the use of fixed storage remains low in all cases. A sensitivity analysis was conducted on the battery size used. It revealed that small batteries had a considerable impact on peak reduction, but the returns diminished with increasing battery size. Increasing the battery size beyond 50 kWh had no further effect on peak reduction.

3.4.2 MAXIMUM ANNUAL PEAK POWER EXCHANGED WITH THE GRID

The scenarios are compared in terms of a few metrics, which provide insight into the simulation results. The first metric considered is the highest annual peak in each scenario. These peaks have a magnitude which is generally close to the transformer rated capacity and occur rarely—a few times in the transformer lifetime. They lead to a type of transformer loading known as short term emergency loading, involving a very high demand occurring for periods of half an hour or less. However, despite the short duration and relative rarity of their occurrence, these overloads can cause considerable damage. Increased hot-spot temperatures, resulting in the evolution of free gas from insulation and insulating fluid, reduced mechanical strength and deformation of conductors and structural insulation, and high internal pressures resulting in leaking gaskets or loss of oil can all be results of short term emergency loading. These loads can considerably shorten the lifespan of these assets [13]. A reduction in the highest annual

peak indicates a reduction in the intensity of these events. Fig. 3.5 illustrates the peak annual power demand compared across the three scenarios and the two reference cases.

The comparison shows that smart charging for peak reduction in the absence of EV demand forecasting is effective at the reduction of short term peak loads, but this effect is limited (about 16% peak reduction relative to unscheduled charging). Further, the magnitude of peak reduction in the absence of EV demand forecasting is considerably less than that possible with perfect forecasting of future EV demand (about 54% reduction), which is the case often assumed in the literature.

The availability of single forecasts based on average demands in the past result in an increase in the effectiveness of reducing short term peak loads. Peaks are reduced by an additional 20% relative to unscheduled charging. Consideration of multiple possible forecasts across which the system works in a robust manner further reduces the peak power exchange of the system. Such a system had an annual peak of 39% lower than that found in unscheduled charging.

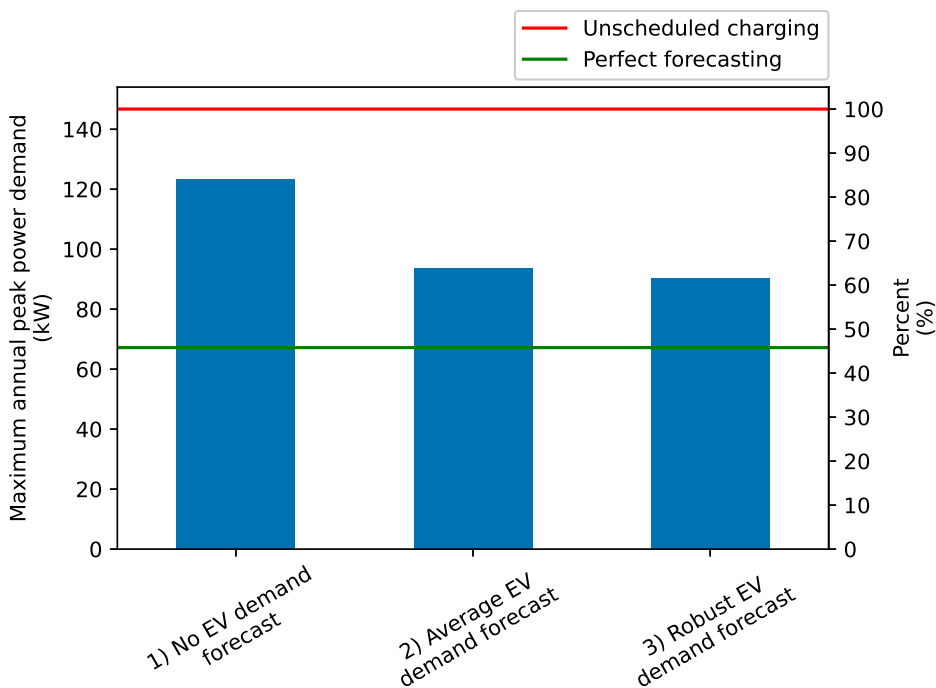

Figure 3.5: Comparison of annual peak power exchanged with the grid.

3.4.3 DURATION OF PEAK LOADS

While the previous metric considered short term load intensity, it did not consider the frequency of occurrence of peaks of marginally smaller magnitude, whose impact is similar to that of the annual peak. A comparison of load duration curves can provide further insight. Fig. 3.6 focuses on the leftmost section of the curve, where the highest peaks are present.

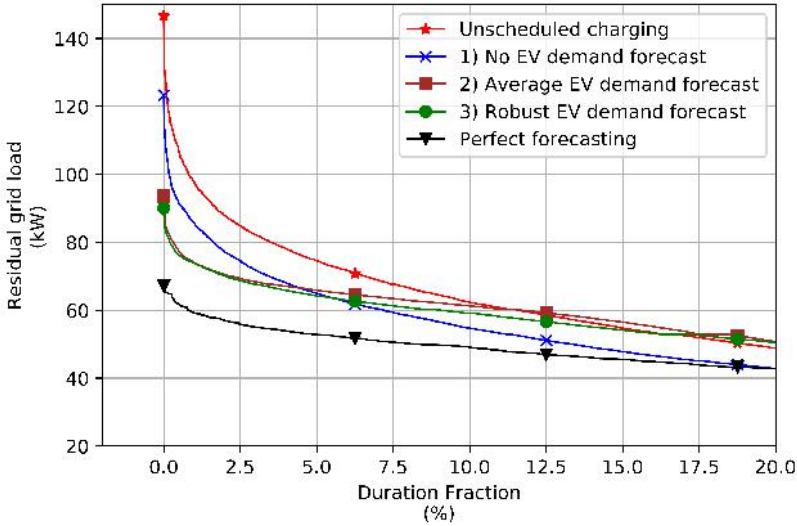

Figure 3.6: Load duration curves.

The downward shift of the y-intercept through scheduled charging represents the reduction in the magnitude of annual peak loads, whereas the leftward shift near the y-intercept represents the reduction in the number of peaks. Scheduled charging without EV demand forecasting, in addition to lowering the magnitude of peaks, is also found to reduce the number of peaks. The curve reveals that the times for which loads are greater than 100 kW are reduced by more than half while the times for which loads are greater than 80 kW are reduced by about half.

The provision of EV demand forecasting further reduces these durations. Loads above 100 kW are avoided altogether and the number of peaks greater than 80kW are greatly reduced. There is no clear advantage of robust forecasting over average forecasting in this case, with both methods providing similar reductions in the number of peaks that the asset is exposed to.

3.5 CONCLUSIONS

The goal of this chapter was to quantify the peak load increase when uncertainty is involved in charge scheduling of electric vehicles at a solar parking lot. It further aimed to develop strategies for scheduling charging in a manner that minimised the peak electricity load at the point of common coupling of the parking lot while taking this uncertainty into account. Since short duration high peaks have the maximum impact on transformer aging, these were the peaks that were focused on.

The set up considered included a solar parking lot with 40 spaces located at a workplace. It included a 120 kWp solar array, 40 EV charge points and a 50 kWh stationary battery. The arrival and departure of EVs, which were parked and plugged in at the parking lot, were simulated over a year. MPC was the method used to optimally schedule the charging of EVs in the parking lot over the year. The operation of the system was simulated over a year in terms of the energy exchanged by the parking lot with the grid.

The system was considered in three scenarios:

1. No EV demand forecast: EV charging is scheduled without a forecast of energy demand for EVs arriving in the future
2. Average EV demand forecast: EV charging is scheduled with a single forecast of energy demand for EVs arriving in the future which is based on average values.
3. Robust EV demand forecast: EV charging is scheduled to be robust across a range of possible energy demands for EVs arriving in the future

The scheduling for each scenario was formulated as an optimisation problem. The operation of the solar carport was simulated in each scenario for a year based on the solution of the optimisation problem. The scenarios were compared with two reference cases: unscheduled charging, which is the current norm, and charging with perfect forecasting of EV demand, which represents the limits of the effectiveness of the system at peak reduction.

The results show that for parking locations with charging, which are currently close to peak load capacity, scheduling of EVs can be used to reduce both the magnitude as well as the frequencies of peak loading on distribution level assets. The magnitude of the peak reduction is however considerably less than the peak reduction possible with perfect forecasting of future EV demand, which is often considered in the literature. Table 3.3 displays the results of annual peak reduction in the scenarios considered:

Table 3.3: Annual peak power across scenarios.

Nr.	Scenario	Annual Peak Power (kW)	Relative Peak Reduction (%)
Ref	Unscheduled charging	147	0%
1	No EV forecast	123	16% (↓)
2	Average EV forecast	94	36% (↓)
3	Robust EV forecast	90	39% (↓)
Ref	Perfect forecasting	67	54% (↓)

Without EV demand forecasting, the maximum annual peak load of the solar carport was reduced by 16% in our case relative to unscheduled charging. This was, however, considerably less effective than in the reference case with perfect forecasting, where the magnitude of the annual peak was reduced by 54%. The inclusion of a single 24 h horizon EV forecast reduced the peak in the solar parking lot by 36%, increasing the effectiveness of the scheduled charging by an additional 20%. Consideration of multiple forecasts of possible EV demand and robust adjustment of the schedule for the performance of the worst possible forecast marginally improved the effectiveness of the scheduling, reducing the peak by 39%.

In addition to reducing the magnitude of peak loads, scheduling of EV charging also has the effect of reducing the number of peaks that distribution level assets were subject to. The use of EV demand forecasting was found to have the effect of considerably reducing this number. However, in this case, the consideration of multiple forecasts provides no clear advantage over a single forecast.

An economic analysis of the system was considered out of the scope of this work. As such, the cost-benefit analysis of scheduling EV charging versus upgrade of the grid connection was not performed. However, preliminary investigation indicates that there is considerable value for the parking lot owner through the implementation of the system described in this work. In the USA, capacity charges for the grid connection at EV charging sites can be higher than \$2000/month, causing the electricity utility bills of some businesses to increase by a factor of four [14]. Similarly, in the Netherlands, the grid capacity cost is €190/year per charge point or 37% of the annual operational costs for the charge point excluding energy costs and about 20% of the costs including energy [15]. Although case-specific, peak reduction does have considerable economic value for system operators.

LIST OF SYMBOLS

Symbol	Definition	Unit	Notes
$E_{fcst}(t)$	Forecasted PV generation: $E_{PV}(t) + \omega_{PV}(t)$	kWh	
E_{grid}^{\max}	$\max(E_{grid}(k), \dots, E_{grid}(k + N_p - 1))$	kWh	
E_{grid}^{\min}	Max energy that can be sent to the grid Grid exchange:	kWh	32 kWh = 120 kW · 1.05 · Δt
$E_{grid}(t)$	$E_{load}(t) - E_{PV}(t) + \sum_{i=1}^{N_b} E_i(t)$	kWh	
$E_i(t)$	Energy to (+) or from (-) battery <i>i</i> at time <i>t</i>	kWh	
$E_{load}(t)$	Load from lighting at time <i>t</i>	kWh	
$E_{PV}(t)$	Generation from solar power at time <i>t</i>	kWh	
<i>i</i>	Index for each battery, 1 to 40 = EVs, 41 = fixed storage	-	$i \in \{1, \dots, N_b\}$
<i>k</i>	Current time step	-	$k \in \{1, \dots, N_T\}$
M_i	Max possible value of $E_i = \rho_i^{\max} \cdot \Delta t$	kWh	
m_i	Min possible value of $E_i = -\rho_i^{\max} \cdot \Delta t$	kWh	
N_b	Total number of batteries	-	41 = 40 EVs + 1 battery
N_e	Number of errors in the bounded set	-	10,000

Continued on next page

Table 3.4 – continued from previous page

Symbol	Definition	Unit	Notes
N_p	Number of time steps in MPC time horizon	-	$96 = 24 \cdot 4$
N_T	Number of time steps in one full simulation	-	$34,944 = 24 \cdot 4 \cdot 364$
P_i^{\max}	Maximum power to or from battery i	kW	EVs 7.4 kW, battery 50 kW
$S_i(t)$	Energy stored in battery i at time t	kWh	
$S_i^{\max}(t)$	Maximum energy allowed in battery i at time t	kWh	
$S_i^{\min}(t)$	Minimum energy allowed in battery i at time t	kWh	
$\overline{S_i^{\max}}(t)$	Average value for the maximum energy in battery i at time t	kWh	
$\overline{S_i^{\min}}(t)$	Average value for the minimum energy in battery i at time t	kWh	
t	time step within MPC horizon	-	$t \in \{k, \dots, k + N_p - 1\}$
$z_i(t)$	$z_i(t) = \delta_i(t) \cdot E_i(t)$	kWh	
Δt	Length of a single time step	h	15 min = 0.25 h
$\delta_i(t)$	For battery i at time t : 0 if discharging, 1 if charging	$\{0, 1\}$	
$\eta_{chg,i}$	Charging efficiency of battery i	-	
$\eta_{dis,i}$	Discharging efficiency of battery i	-	

Continued on next page

Table 3.4 – continued from previous page

Symbol	Definition	Unit	Notes
$\Omega_{PV}^*(t)$	Bounded set of PV forecasting errors $\{\omega_{PV}^{(1)}, \dots, \omega_{PV}^{(N_e)}\}$	-	
$\omega_{PV}(t)$	PV forecasting error at time t	kWh	
$\omega_{PV}^{\max}(t)$	Max PV forecasting error in the set $\Omega_{PV}^*(t)$	kWh	
$\omega_{PV}^{\min}(t)$	Min PV forecasting error in the set $\Omega_{PV}^*(t)$	kWh	
$\omega_{S_i^{\max}}(t)$	Uncertainty in the value of $S_i^{\max}(t) - S_i^{\min}(t)$	kWh	
$\omega_{S_i^{\min}}(t)$	Uncertainty in the value of $S_i^{\min}(t) - S_i^{\min}(t-1)$	kWh	

REFERENCES

-
- [1] Clement-Nyns, K., Haesen, E., Driesen, J., “The Impact of Charging Plug-In Hybrid Electric Vehicles on a Residential Distribution Grid.” In: *IEEE Transactions on Power Systems* 25.1 (2010), pp. 371–380. ISSN: 0885-8950. DOI: 10.1109/TPWRS.2009.2036481.
- [2] Cooper, P. *Smart charging of electric vehicles - Institutional bottlenecks and possible solutions*. Utrecht, the Netherlands: Pricewaterhouse Cooper, 2017.
- [3] Sortomme, E., El-Sharkawi, M. A., “Optimal Scheduling of Vehicle-to-Grid Energy and Ancillary Services.” In: *IEEE Transactions on Smart Grid* 3.1 (2012), pp. 351–359. ISSN: 1949-3061. DOI: 10.1109/TSG.2011.2164099.
- [4] Kam, M., Sark, W., “Smart charging of electric vehicles with photovoltaic power and vehicle-to-grid technology in a microgrid; a case study.” In: *Applied Energy* 152 (2015), pp. 20–30. ISSN: 03062619. DOI: 10.1016/j.apenergy.2015.04.092. URL: <http://linkinghub.elsevier.com/retrieve/pii/S0306261915005553>.
- [5] Sarantis, I., Alavi, F., De Schutter, B., “Optimal power scheduling of fuel-cell-car-based microgrids.” In: *2017 IEEE 56th Annual Conference on Decision and Control (CDC)*. 2017 IEEE 56th Annual Conference on Decision and Control (CDC). 2017, pp. 5062–5067. DOI: 10.1109/CDC.2017.8264409.
- [6] Knap, W. “Horizon at station Cabauw.” In: *Koninklijk Nederlands Meteorologisch Instituut, De Bilt* (2007). Publisher: PANGAEA Type: dataset. DOI: 10.1594/PANGAEA.669511. URL: <https://doi.pangaea.de/10.1594/PANGAEA.669511>.
- [7] Stein, J. S., Holmgren, W. F., Forbess, J., Hansen, C. W., “PVLIB: Open source photovoltaic performance modeling functions for Matlab and Python.” In: *2016 IEEE 43rd Photovoltaic Specialists Conference (PVSC)*. 2016 IEEE 43rd Photovoltaic Specialists Conference (PVSC). 2016, pp. 3425–3430. DOI: 10.1109/PVSC.2016.7750303.
- [8] Apostolaki-Iosifidou, E., Codani, P., Kempton, W., “Measurement of power loss during electric vehicle charging and discharging.” In: *Energy* 127 (2017), pp. 730–742. ISSN: 03605442. DOI: 10.1016/j.energy.2017.03.015. URL: <https://linkinghub.elsevier.com/retrieve/pii/S0360544217303730>.
- [9] Shareef, H., Islam, M. M., Mohamed, A., “A review of the state-of-the-art charging technologies, placement methodologies, and impacts of electric vehicles.” In: *Renewable and Sustainable Energy Reviews* 64 (2016), pp. 403–420. ISSN: 13640321. DOI: 10.1016/j.rser.2016.06.033. URL: <https://linkinghub.elsevier.com/retrieve/pii/S1364032116302568>.
- [10] Daina, N., Sivakumar, A., Polak, J. W., “Modelling electric vehicles use: a survey on the methods.” In: *Renewable and Sustainable Energy Reviews* 68 (2017), pp. 447–460. ISSN: 1364-0321. DOI: 10.1016/j.rser.2016.10.005. URL: <http://www.sciencedirect.com/science/article/pii/S1364032116306566>.
- [11] Francfort, J. “EV Project Data and Analytic Results.” 2014 DOE Vehicle Technologies Office Review. Idaho Falls, USA, 2014. URL: https://www.energy.gov/sites/prod/files/2014/07/f18/vss137_francfort_2014_o.pdf.
- [12] Bemporad, A., Morari, M., “Control of systems integrating logic, dynamics, and constraints.” In: *Automatica* 35.3 (1999), pp. 407–427. ISSN: 0005-1098. DOI: 10.1016/S0005-1098(98)00178-2. URL: <https://www.sciencedirect.com/science/article/pii/S0005109898001782>.
- [13] IEEE, *IEEE Guide for Loading Mineral-Oil-Immersed Transformers and Step-Voltage Regulators*. New York, USA: IEEE, 2012, pp. 1–123. URL: <https://ieeexplore.ieee.org/stamp/stamp.jsp?tp=&arnumber=6166928>.
- [14] Smith, M., Castellano, J., *Costs Associated With Non-Residential Electric Vehicle Supply Equipment*. US Department of Energy: Clean Cities, 2015, p. 43. URL: https://afdc.energy.gov/files/u/publication/evse_cost_report_2015.pdf.
- [15] Blok, R. *Verslag Benchmark Publiek laden 2018 - Sneller naar een volwassene markt*. Nationaal Kennisplatform Laadinfrastructuur, 2018. URL: https://www.nklnederland.nl/uploads/files/Verslag_Benchmark_Publiek_Laden_2018_-_Sneller_naar_een_volwassen_markt_FINAL.pdf.

OFF-GRID SOLAR CHARGING OF ELECTRIC VEHICLES AT LONG-TERM PARKING LOTS

Abstract

This work analyses the effectiveness of an off-grid solar photovoltaic system for the charging of electric vehicles (EVs) in a long-term parking lot. The effectiveness of charging is investigated through analysis of the states of charge (SoC) at departure of EVs plugged in at the parking lot over the simulated year. Although the share of vehicles leaving with inadequate charge over the entire year is small, this share is relatively high during low irradiance winter months. We show that an increase in efficiency of the solar modules used in the system and an increase in the minimum duration of time spent at the parking lot are effective within limits at improving charging adequacy. We then formulate three strategies to allocate the available energy in the system with the objective of reducing the number of vehicles leaving at lower SoCs: 1) curtailment of charging beyond 80% state of charge, 2) prioritised charging of vehicles at low SoCs and 3) prioritised charging based on both SoC and time before departure. We identify the strategy prioritising vehicles with low state of charge to be most effective, but performance in the worst month remains a challenge for the location considered.

This chapter is adapted from **Ghotge, R.**, Wijk, A., Lukszo, Z., “Off-grid solar charging of electric vehicles at long-term parking locations.” In: *Energy* 227 (2021), p. 120356. ISSN: 0360-5442. DOI: 10.1016/j.energy.2021.120356

4.1 INTRODUCTION

The global uptake of EV is rapidly increasing, reaching a worldwide market share of 2.6% in 2019 [1]. The increasing consumer and public spending on EVs in combination with the increasing market share show a trend towards the electrification of the mobility sector. Electrification of mobility is also desirable from a climate perspective in locations like Europe where the electricity mix has a relatively low carbon intensity [2].

Larger EV fleets lead to an increase in the demand for both electricity and EV charging infrastructure. Providing infrastructure for the charging of electric vehicles at public locations is a key enabler for electric vehicle uptake and is essential for their widespread adoption [3]. However, considerable capital costs are involved in the installation of large scale charging infrastructure, particularly where there are clusters of charging stations [4]. As much as 20% of the initial costs and 35% of annual non-energy related recurring costs are associated with the provision of grid capacity [5]. Further, in many locations, capacity constraints in existing distribution level infrastructure prevent the connection of additional electrical load.

This chapter analyses an off-grid solar PV system for charging EVs plugged-in at long-term parking lots. These parking lots, where vehicles are parked for long durations (typically more than 24 hours), are often found in airports, ports and logistics hubs. The proposed system would have the following benefits:

1. The elimination of the grid capacity would lead to significant reduction in the capital costs of installation of EV charging infrastructure.
2. With the falling costs of electricity generation through solar photovoltaics, local generation would reduce the energy-related costs of providing electric vehicle charging.
3. EV charging would become possible even at locations without (or with a highly constrained) grid infrastructure.

We model a solar parking lot with 100 parking spaces, which are covered with solar modules, located at the city of Lelystad, the Netherlands, the site for a new airport. The generation of electricity through the photovoltaic array is simulated over a year together with the arrival and departure of BEVs which are charged in the parking lot. The operation of the parking lot over a year is simulated to estimate the adequacy of charging of EVs using the off-grid solar PV system. Various measures are then proposed for improving the adequacy of charging of the EV fleet and they are compared.

Several previous works have investigated solar charging for electric vehicles: Birnie [6] recommended locating solar arrays at workplaces due to the temporal overlap between charging in the daytime and peak solar generation. The daily energy generated

was estimated to be sufficient for the range covered by most commuters within the 15-20 mile radius of their workplace. The insufficiency of generation in winter was acknowledged but not elaborated upon.

Denholm et al. [7] extended the idea of solar charging at workplaces. A modest PV capacity at workplaces in Texas was found to reduce the need for the additional grid capacity required for workplace EV charging by shaving of demand peaks. Workplace EV charging was also found to increase the use of low value and potentially curtailed solar production in summer.

Additional benefits gained by co-location of solar arrays and EV charging related to carbon emission reductions and socio-economic aspects were described in [8, 9]. The technology of solar carports was reviewed in [10] while the techno-economic feasibility of a system in Lisbon, Portugal was analysed in [11]. All these studies focus entirely on grid connected systems located at workplaces. As such, the assumption was that vehicles would be available for charging for a period limited by an average workday of around 8 hours. Alternative locations with different parking profiles were not explored.

Tong et al. [12] modelled an off-grid solar workplace charging station based on a single vehicle system built in the University of California, Davis, USA. The system included a 1.44 kWp solar array over a single carport with a 13.9 kWh second-life Li ion battery pack for stationary energy storage. For conditions in California, the system was found to completely charge the daily energy demand of the plugged in EV (10 kWh) for 194 days in the year. The battery was also found to be highly underutilised in winter since there was rarely enough solar energy with which to charge it sufficiently. The authors did not, however, further quantify or address the effects of inadequate charging of EV batteries by the proposed system. Although increasing the stationary battery pack capacity was investigated, it was not found to improve system performance greatly. Further, no recommendations were made for alternative applications of the off-grid solar parking lot. Bhatti et al. [13] reviewed solar photovoltaic systems for EV charging, with a focus on power converter design. Converter designs for use in off-grid photovoltaic charging systems were briefly discussed, though specific applications were not investigated.

Chandra Mouli et al. [14] analysed the system design of a workplace parking lot for grid-connected EV charging. Increasing the capacity of stationary batteries was investigated to reduce the dependence of the system on the grid for delivering adequate charging to the plugged in vehicles. Even extremely large battery packs per carport, with similar capacity as the batteries in EVs themselves, were unable to completely eliminate the reliance of EV charging on electricity from the grid for adequate charging.

Off-grid solar powered systems for charging electric vehicles including electrolyzers for hydrogen production, local hydrogen storage and fuelling of hydrogen fuel cell electric vehicles were analysed in both [15] and [16]. Since fuel cells were included in the charging stations in both cases, long-term storage of electricity was possible in the

form of hydrogen. Although neither study explicitly looked at adequacy of charging of the vehicles, the energy provided by the off-grid system appeared to be inadequate since both works also incorporate backup diesel generators. Regardless of the nature of storage, whether batteries or hydrogen, the off-grid solar system was unable to independently and adequately meet the EV charging demand at workplaces.

Most solar EV charging studies tend to focus on workplaces, due to the temporal match between charging profiles and peak solar production. The analysis of alternative load profiles for EVs, with lower charging demand, is lacking. In this study, we focus on a novel profile found at long-term parking locations. These are parking lots where vehicles are parked for long periods of time, typically on the order of days to weeks. They can represent large shares of parking facilities. For example, at most airports, long-term parking lots serve about 25% of parking facility users, but occupy up to 90% of parking spaces [17]. The charging speeds required for EVs are expected to be considerably lower at long-term parking than those at workplaces, where the durations of parking (around 8-9 hours) imposes a requirement on the speed of charging. As such, both the total energy demand and peak loads are lower. This suggests that off-grid solar systems are better suited for these profiles than for workplace load profile. To the best of the authors' knowledge, this is the first work to analyse such a system.

The main research question that this chapter aims to answer is:

To what extent is an off-grid solar array suitably sized for a long-term parking lot able to meet the charging demand of plugged-in EVs?

with the following sub-questions:

1. What is the distribution of SoCs achieved by the vehicles using the system and how many vehicles are inadequately charged?
2. How can the charging facility be better designed to improve the adequacy of charging provided?
3. What kind of smart approaches can be used to improve the adequacy of charging provided and what additional data is needed?

The contributions of this chapter beyond previous literature are listed below:

1. We analyse EV charging profiles at long-term parking lots - a type of load profile that previous works have not investigated.
2. We develop a method where the adequacy of charging is analysed through the distribution of states of charge of EV batteries on departure. This differs from studies which use the more conveniently measured quantity of average daily electricity charged per charge point (termed as success of public charging stations, for further details refer [18]).

- The techniques used for assigning priorities for vehicles here are derived from queuing theory. Conventionally, such techniques were used to analyse server-customer systems with applications ranging from communication networks to logistics management. They have found recent application in EV charge scheduling. For example, they were used in [19] to reduce cost of EV charging while in [20], they were used to analyse the performance of charging EVs in various configurations. To our best knowledge, this is the first work to apply these techniques to EV charging in off-grid systems and compare various strategies using them.

This chapter is structured as follows: in section 6.2, the physical system is described, together with the modelling of individual components and an overview of the data used for simulations is provided. In section 4.3 we describe the formulation of the base case and the adequacy of charging of EVs using the parking lot over a year. The performance during the critical periods in winter and the sensitivity of the results to design parameters is analysed. In section 4.4, we formulate and compare various strategies to improve the adequacy of charging for the EV fleet through prioritised charging. Finally, in section 5.5, we present the conclusions of this chapter.

4.2 SYSTEM DESCRIPTION AND DATA USED

The system considered is an off-grid solar parking lot with 100 parking spaces located at the long-term parking facilities at the airport in Lelystad, the Netherlands. Relative to the total number of parking spaces available at most airports¹, this represents a small fraction. We assume every parking space to be covered by a solar canopy and to have a charge point for EV charging. A schematic of the proposed system is shown in Fig. 4.1.

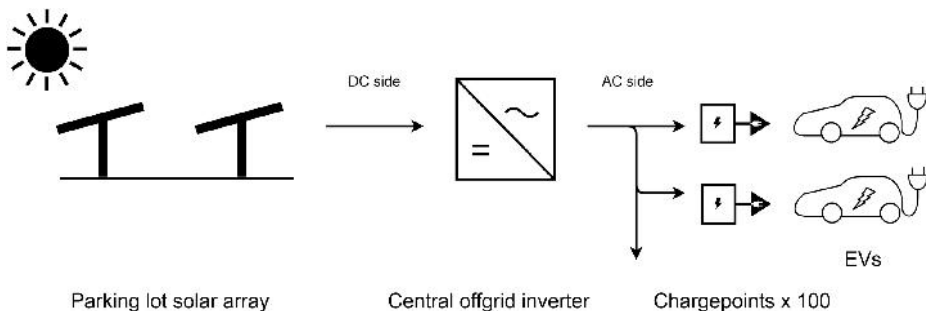

Figure 4.1: System schematic of an off-grid solar parking lot for EV charging

¹ Large airports have parking capacities in the range of several tens of thousands of parking spaces [21]

4.2.1 SOLAR PV ARRAY AND INVERTER

The minimum ground coverage area per parked vehicle is taken to be 12.5 m^2 based on Dutch regulations for covered parking spaces [22]. Based on a conventional 60-cell module area of 1.6 m^2 and a low tilt, this gives a ratio of 10 solar modules per parked vehicle. A central grid-forming inverter is chosen rather than a modular system primarily to enable the electricity generation from unoccupied parking spaces to be used to charge EVs in occupied spaces. Further details on the PV array and inverter specifications are provided in Table 5.1.

Table 4.1: Solar Array and Inverter Characteristics

Characteristic	Value
Site location	Lelystad, the Netherlands
Site latitude	52.4°N
Site longitude	5.5°E
Solar modules per parking space	10
Number of parking spaces	100
Module technology	Crystalline silicon [23]
Module rating	320 Wp
Module efficiency	19.2%
Total installed capacity	320 kWp
Array azimuth	South
Array tilt	15°
Capacity factor	8.9 %
Inverter efficiency	98% [24]

Satellite derived irradiance and meteorological data for the site location is sourced in the form of Typical Meteorological Year (TMY) files from the Photovoltaic Geographical Information System (PVGIS) online tool [25]. We model the electricity production of the solar array over a year in hourly timesteps using the open source tool PVLIB version 0.7.2 in Python [26].

4.2.2 CHARGE POINTS

The charge points considered are single phase AC charge points with 16 A current capacity. They are thus limited to 3.7 kW power capacity. The losses in the charge points as a result of charging are taken to be 0.3% [27].

4.2.3 ELECTRIC VEHICLES AND THEIR BATTERIES

The vehicles being charged in the parking space are assumed to be similarly distributed as the top ten models in the current Dutch EV fleet. Only battery electric vehicles (BEVs), which generally have larger batteries than PHEVs, are considered in order to test the limits of the system. Since range anxiety is typically not a consideration for PHEV drivers, it is debatable whether they would choose to charge their vehicles at such a location - another reason for their exclusion from this study.

The BEVs considered range from the 32 kWh Volkswagen Golf to the 95 kWh Tesla Model 3 and Model X. Data on battery sizes is sourced from the EV database [28] while the distribution of vehicles is based on Dutch government statistics [29]. The distribution of vehicles is shown in Fig. 4.2(a).

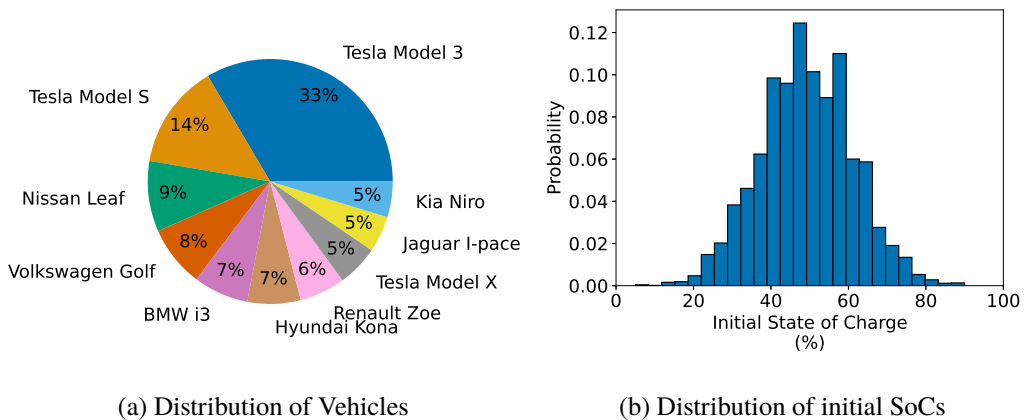

Figure 4.2: EV distribution and initial States of Charge on arrival

The distribution of initial states of charge of the vehicles when plugging in at the solar parking lot is based on data collected in the EV Project. The dataset provides BEV battery SoCs at the beginning of charging sessions at away-from-home locations, collected over charging events across several years from over 5000 BEVs [30]. Fig. 4.2(b) shows the normalised distribution of initial states of charge of all the vehicles - a Gaussian distribution around a mean of 50%. Datasets from other EV trials in the UK

[31], Australia [32] and Germany[33] across a variety of charge point locations show similar distributions of initial SoC at the point of plug-in.

The charging of EV batteries is modelled using the Modified Kinetic Battery Model [34], based on which the states of charge (SoC) of individual EV batteries are calculated. It is a commonly applied battery model used in time series energy system modelling [35–37]. It is an analytical battery model based on chemical kinetics, using battery datasheet values to approximate charging and discharging behaviour with relative accuracy [36].

4.2.4 VEHICLE OCCUPANCY AT THE PARKING LOT

The arrival times and durations of stay of the vehicles considered in this study are based on data collected at the economy long-term parking lot at Boston Logan International Airport. The two datasets used are

1. time series data showing the number of vehicles entering the specific parking lot at an hourly rate over an entire month in August 2016
2. distribution of the total number of vehicles based on the time spent in the parking lot

Research studies conducted at airports around the world show segmentation of parking visitors based on duration of stay into short term, long-term, meet and greet, etc. [17, 38]. Typically, the shares of parked vehicles in different segments are found to vary, but the common characteristics within each segment remain similar [39]. Thus, although we cannot explicitly demonstrate that patterns specific to the segment of long-term parked vehicles which are analysed here are representative of those at other locations, we assume this to be the case.

Daily and weekly seasonality can be seen in the vehicle entry time series data, based on which seasonal indices are calculated. The vehicles are then assigned durations according to the distributions of the vehicles parking durations in the data, with a minimum duration period of 24 hours. The arrival rate is then scaled to limit occupancy of the parking space to 100 spaces. Fig. 4.3(a) shows the distribution of durations spent by vehicles in the parking lot over the year while Fig. 4.3(b) shows the occupancy of the parking lot over the year.

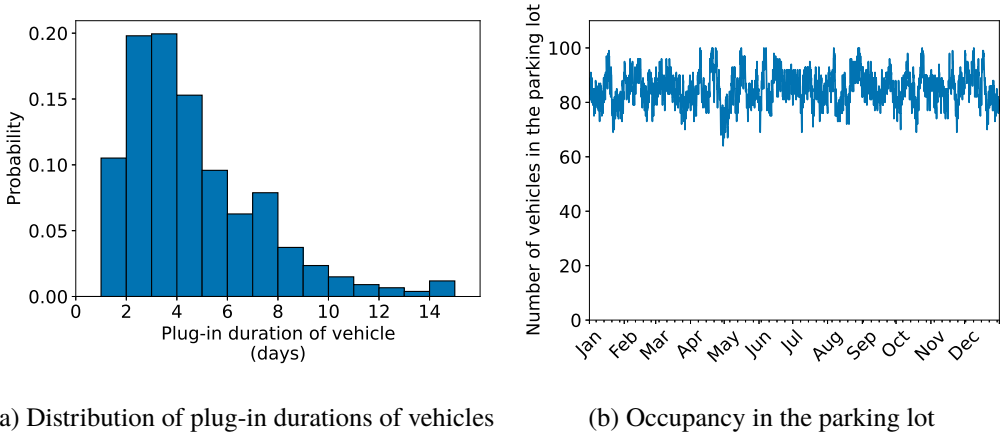

Figure 4.3: Distribution of plug-in durations and occupancy in the parking lot

In large parking lots, it can be difficult to find the last parking spaces. Hence these parking lots are typically considered to be full when 85 to 95% of spaces are occupied [40]. In this context, the occupancy considered here is relatively high.

4.3 IMMEDIATE CHARGING OF THE OFF-GRID FLEET

The time series data from the solar array, together with the EV occupancy is used to simulate the operation of the system over a year. As a base case, immediate charging is used to estimate the adequacy of charging of the EVs using the parking lot.

4.3.1 FORMULATION OF IMMEDIATE CHARGING IN THE OFF-GRID SOLAR SYSTEM

Let I be the total number of EVs using the parking lot over the year and J be the total number of charge points in the system² over the considered time interval, $1 \dots T$. The i^{th} vehicle enters the parking lot at t_i^{entry} and exits at t_i^{exit} , remaining at the parking lot for a plugged-in duration of $D_i = t_i^{exit} - t_i^{entry}$. At any given timestep, $t = n$, the number of vehicles in the parking lot i.e. its occupancy, l_n , is known. Let \bar{l}_n be the set of l_n unique values of i at the timestep n , which represent the set of identities of vehicles in the parking space at n .

At any given timestep, n , the State of Charge (SoC) of the i^{th} vehicle is $S_{i,n}$. When the i^{th} vehicle arrives in the parking lot, i.e. $n = t_i^{entry}$, its state of charge, $S_{i,n}$, is known. At all other timesteps, it is a function of the charged power to the vehicle.

The power capacity constraint of every charge point is C . The time varying SoC dependent charging power capacity of the battery of the i^{th} vehicle at the timestep, n , is

² J also equals the number of parking spaces

denoted by $c_{i,n}^{SoC}$ and is set by the battery model. At every timestep n , the power capacity of the i^{th} plugged-in EV, $c_{i,n}$, depends on the minimum constraint set by the charge point and the battery. Thus, for every timestep the power capacity of the i^{th} plugged in EV is

$$c_{i,n} = \text{minimum}(C, c_{i,n}^{SoC}) \quad (4.1)$$

If there were no constraint on the available electricity, each vehicle would charge at the limit of its capacity, $c_{i,n}$. However, in cases where the available power is limited by the solar array production in the n^{th} timestep after losses, P_n^{PV} . Thus, at each timestep, n , the total power charged to the plugged in fleet, is

$$\begin{aligned} P_n^{fleet} &= \sum_{i \in \bar{I}_n} P_{i,n} \\ &= \text{minimum}(P_n^{PV}, \sum_{i \in \bar{I}_n} c_{i,n}) \end{aligned} \quad (4.2)$$

The power charged to the i^{th} vehicle is then calculated as

$$P_{i,n} = \begin{cases} c_{i,n}, & P_n^{fleet} \leq P_n^{PV} \\ \frac{P_n^{PV}}{P_n^{fleet}} \cdot c_{i,n}, & P_n^{fleet} > P_n^{PV} \end{cases} \quad (4.3)$$

Thus, in case of constrained power, charging of all vehicles is curtailed by the same fraction. The battery model is then used to calculate the SoC of each vehicle after charging.

4.3.2 ADEQUACY OF CHARGING

The objective of the system is to provide adequate charging to as many vehicles as possible. We investigate this idea of adequacy of charging by analysing the SoCs of all the EVs achieved at their respective times of departure over the simulated year.

The solar production over the year and the power charged to the fleet are shown in Fig. 4.4(a). Considerable excess electricity is generated, which needs to be curtailed in summer months³. On the other hand, the solar yields in winter are far lower and restrict the charging of EVs considerably. These figures reveal that the provision of adequate charging to the plugged in EVs has a clear seasonal dependence.

The states of charge of all the vehicles at the point of departure from the parking lot over the year are shown in Fig. 4.4(b). Almost all the vehicles charged in the summer months are fully charged by the time they are required to depart. On the other hand, in the winter

³ about 24% of generated energy is curtailed, seen in yellow in Fig. 4.4(a)

months, most vehicle are only partially charged, leaving with a lower SoC. A relatively low number of EVs in winter leave with fully charged batteries.

Fig. 4.4(c) shows the probability distribution of SoCs at the point of departure of EVs from the parking lot while Fig. 4.4(d) shows the cumulative probability distribution of the same. Over the entire year, about half of the vehicles (51%) leave fully charged whereas the rest leave at lower states of charge. However, even among these EVs where the batteries are not fully charged, most vehicles depart with high states of charge.

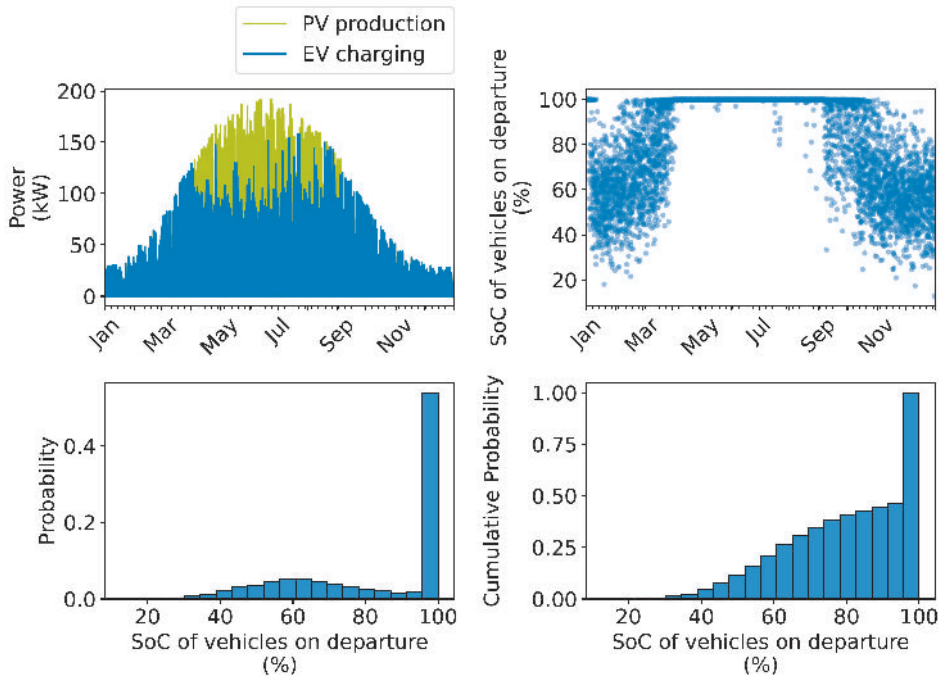

Figure 4.4: (a) Solar power generation and and off-grid EV charging over the year (b) SoCs on departure of EV charging at the solar parking lot over the year (c) Distribution of SoCs on departure and (d) Cumulative distribution of SoCs on departure

Over the entire year, a relatively small fraction of vehicles leave with inadequate charge. As shown in Table 4.2, about 20% of EVs depart with SoCs lower than 60% while about 3% of EVs depart with SoCs lower than 40% over the entire year. These EVs may not have sufficient range for future trips - a situation to be avoided for a commercial park and charge facility. As Fig. 4.4(b) shows, the vast majority of events where EVs departed with inadequate charge are in winter. As such, we further investigate this adequacy during the periods when the system performance is lowest - the worst month in the year.

Table 4.2: Cumulative distribution of vehicles based on SoC at departure: comparison of annual case and critical month case

State of Charge at departure	Fraction of EVs	
	Annual	December
<99	49%	100%
<80	39%	97%
<60	20%	63%
<40	3%	11%

4.3.3 CRITICAL MONTH ANALYSIS

The PV system is expected to meet the load across the whole year with varying irradiance and loads. In order to ensure that the system works satisfactorily across all conditions, we analyse the performance of the system during the month over which system has the worst performance: the critical month. We choose the critical month as the month with the largest number of EVs leaving at SoC lower than 40%. This is found to be the month of December, primarily as a result of low irradiance.

Fig. 4.5(a) shows the distribution of SoCs of vehicles departing from the parking lot in December. Very few EVs are charged to SoCs over 80% and no EVs are fully charged. Most vehicles are charged to the 40-70% SoC range. This distribution is quite different to the distribution seen over the entire year in Fig. 4.4, where a large share of vehicles are fully charged. Fig. 4.5(b) shows the cumulative distribution of SoCs on departure while Table 4.2 shows the difference between the annual distributions and the critical month, December.

63% of EVs in December are found to depart at an SoC lower than 60% while 11% of EVs depart with an SoC lower than 40%. The share of vehicles leaving with inadequate charge is significantly higher in December than over the entire year. Since our objective is to reduce or eliminate the number of vehicles which depart at states of charge which may be considered inadequate by users, we focus on these vehicles. Some methods to raise the SoCs at exit of these vehicles are proposed and investigated in the following sections.

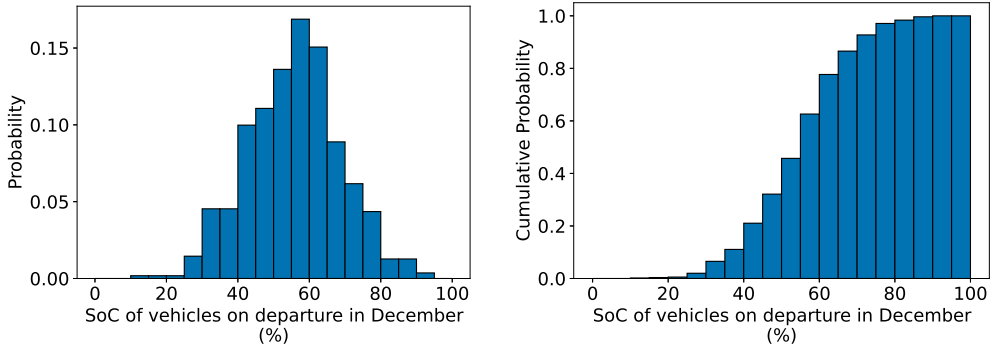

(a) Distribution of SoCs on departure of EV at the solar parking lot in December (b) Cumulative distribution of SoCs on departure in December

Figure 4.5: Distributions of SoCs on departure in December

4.3.4 INCREASING THE ADEQUACY OF CHARGING

We consider two methods to increase the adequacy of charging to these vehicles:

1. Increasing the solar production in winter through the use of higher efficiency solar modules
2. Increasing the minimum duration time for which vehicles are permitted to use the parking lot

4.3.4.1 *Increasing solar production*

The base scenario described in section 4.3.2 makes use of 320 Wp solar modules with about 19% efficiency, around the higher end of commercially used modules. However, commercial projects in recent years have seen the application of increasingly efficient solar modules [41]. We analyse the effects of the use of higher efficiency solar modules at the design stage on the system performance. Laboratory tests measuring module level efficiency current report values as high as 24.4% for monocrystalline silicon [41]. As such, we investigate efficiencies ranging from the value chosen in the base case, 19%, to 24%, where modules which are commercially deployed in the future approach today's laboratory-measured efficiencies.

As before, the system performance is analysed based on the distribution of EVs by their SoC at departure. The results are shown in Fig. 4.6, where the fraction of EVs departing with SoCs below 40% and 60% are plotted as a function of increasing solar module efficiency.

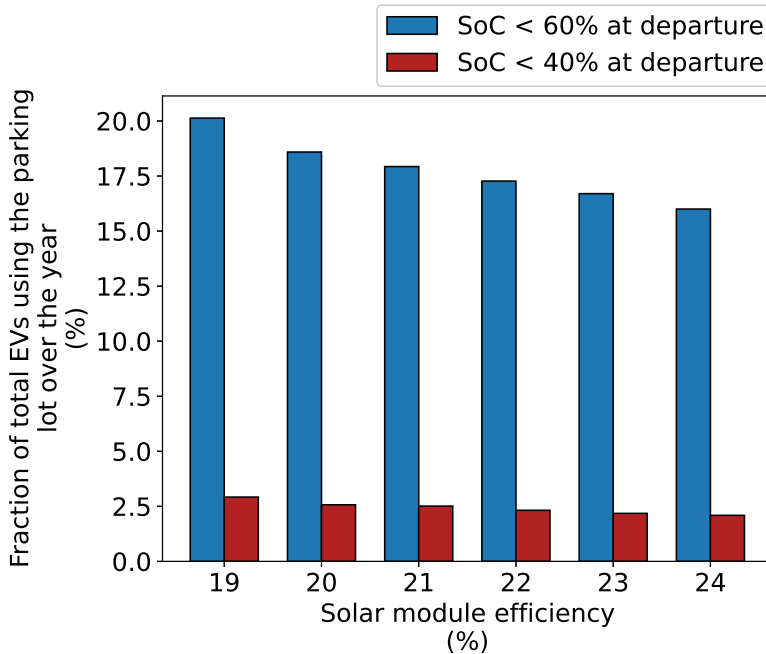

Figure 4.6: Reduction in fraction of EVs leaving at inadequate states of charge due to increase in PV module efficiency

As seen in Fig. 4.6, the fraction of vehicles which leave at states of charge below 60% reduce to some extent but those leaving with SoCs below 40% are relatively unaffected. As such, the improvement in adequacy of charging is very limited since the vehicle in critical need of charging do not receive it. The likely reason is that although the efficiency of energy conversion by the modules is higher, the available resource i.e. the irradiance levels in winter are not enough to generate the required electricity to adequately charge the plugged in vehicles.

4.3.4.2 Increasing minimum parking duration

In the base case, the minimum duration of time that vehicles needed to be parked to be assigned to the long-term parking lot rather than the short term lot was 24 hours. As discussed in section 4.2.4, vehicles in large parking lots are generally divided based on the duration of stay into short term, long-term, meet and greet, etc. The minimum duration for a vehicle to be assigned to long-term parking lots can be as low as 8 hours as in Beijing Airport, China [42], to as long as 5 days in Manchester Airport, UK [43].

Here, we investigate the effects of increasing this limit, which can be achieved through a relatively easily implemented change in parking lot policy. By increasing the minimum

parking duration, the vehicles within the long-term parking lot would, on average, spend longer times plugged in, allowing them more time, and correspondingly more sun hours, to charge. We increase the minimum duration of parking in steps of one day. The occupancy of the parking lot was retained at similar levels - over 80% of the spaces were generally occupied by vehicles. This means that the revenue due to parking fees at the parking lot would remain unaffected, since the parking revenue is linked to occupancy of the parking lot. The results are shown in Fig. 4.7.

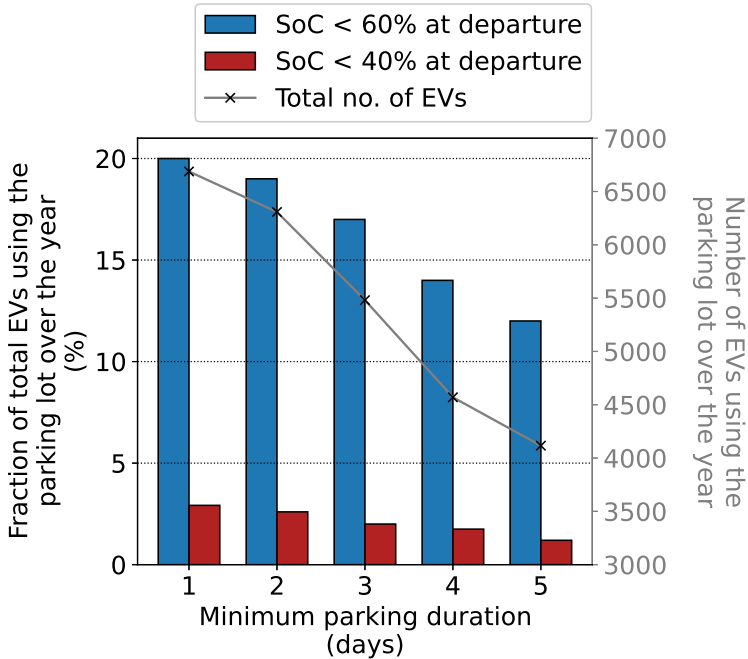

Figure 4.7: Reduction in fraction of EVs leaving at inadequate states of charge due to increase in minimum parking duration

Fig. 4.7 shows that the shares of vehicles leaving with SoCs lower than 60% and lower than 40% are both found to reduce, though they are not eliminated, as a result of increasing the minimum parking duration. This is thus a more effective strategy at reducing the fraction of vehicles leaving at a low SoC than increasing the PV module efficiency.

However, given the same number of parking spaces, with vehicles staying longer, the total number of vehicles using the parking space reduces (shown in gray). The case with a minimum duration of 5 days offers parking for only about 60% of the vehicles as the original case. Such an approach thus reduces the number of vehicles for whom the limited

parking spaces can provide charging. Further, as can be seen in Fig. 4.3(a), a large number of vehicles visiting long-term parking lots park their vehicles for periods between 1 and 5 days. Thus such an approach reduces the fraction of visitors to the facility which can use this particular parking lot. A reduction in number of vehicles means a corresponding reduction in the total load as well. This leads to a higher share of curtailed energy.

Both the use of higher PV module efficiency and increasing the minimum duration of stay at the parking lot have limitations in terms of their effectiveness at increasing the adequacy of charging provided. In order to further increase the adequacy of charging provided by the system, in the next section, we investigate distributing the available energy differently among the plugged in vehicles.

4.4 PRIORITISED CHARGING OF VEHICLES

A fraction of vehicles plugged-in at the off-grid solar parking lot do not receive adequate charging in winter. We now try to allocate the available energy differently among the charged vehicles. The broad idea behind this approach is that vehicles with critically low SoCs need energy more than those with relatively high SoCs. Assigning a priority to the vehicles within the parking lot then enables charging of certain cars faster than others. We identify three strategies to do this:

1. 80% SoC sufficiency
2. Lowest SoC priority
3. Lowest Critical Ratio priority

The formulation of these strategies is initially described, after which they are compared with each other as well as the base case.

4.4.1 FORMULATION OF PRIORITY BASED STRATEGIES

In each of the strategies, we distribute the available electricity among the plugged in vehicles based on a different rule. The first two strategies require data related to the plugged in EV's SoC to be known by the centralised system controller. The final strategy further requires the parking schedule of the vehicles to be known by the system. These strategies are described below:

4.4.1.1 80% SoC sufficiency formulation

Here, we assume that it is of primary importance to charge all vehicles to 80% SoC, a value beyond which further charging is of lower priority. Retaining the earlier notation, at

any given timestep, n , the State of Charge (SoC) of the i^{th} vehicle is $S_{i,n}$. Of the l_n vehicles plugged in at the timestep, n , the SoCs of the vehicles are in the set \overline{B}_n . A subset of \overline{B}_n with $l_n^{SoC < 80}$ elements includes all the values in \overline{B}_n which are lower than 80. The elements of this subset are $\overline{B}_n^{SoC < 80}$ and the identities of the corresponding vehicles are in $\overline{l}_n^{SoC < 80}$. The power consumed by this section of the EV fleet depends on the available PV power in the n^{th} timestep, P_n^{PV} as

$$\begin{aligned} P_n^{fleet = \overline{l}_n^{SoC < 80}} &= \sum_{i \in \overline{l}_n^{SoC < 80}} P_{i,n} \\ &= \text{minimum} \left(P_n^{PV}, \sum_{i \in \overline{l}_n^{SoC < 80}} c_{i,n} \right) \end{aligned} \quad (4.4)$$

Thus, the power charged to the i^{th} connected vehicle is

$$P_{i,n} = \begin{cases} c_{i,n}, & P_n^{fleet = \overline{l}_n^{SoC < 80}} \leq P_n^{PV} \\ \frac{P_n^{PV}}{P_n^{fleet = \overline{l}_n^{SoC < 80}}} \cdot c_{i,n}, & P_n^{fleet = \overline{l}_n^{SoC < 80}} > P_n^{PV} \end{cases} \quad (4.5)$$

In case all vehicles are charged to 80%, then all the vehicles are charged with equal priority as described in 4.3.1.

4.4.1.2 Lowest SoC priority formulation

In this strategy, the objective is to prioritise the charging of vehicles with the lowest state of charge. We assume real time knowledge of the SoC of plugged-in vehicles in this case, as is possible with DC based charge points. As in the previous case, at any given timestep, n , the SoC of the i^{th} vehicle is $S_{i,n}$. At any given timestep, n , let \overline{B}_n be the set of all the states of charge of the l_n plugged in vehicles.

Thus,

$$\overline{B}_n = \underbrace{\{S_{i,n} \cdots\}}_{l_n \text{ terms}} \quad \forall i \in \overline{l}_n \quad (4.6)$$

where \overline{l}_n is the set of l_n unique values of i at the timestep n , and l_n is the occupancy of the parking lot at timestep n .

We define $|\overline{B}_n|$ as the non-decreasing ordered set of elements in \overline{B}_n . Similarly, $|\overline{l}_n|$ is the ordered set of vehicles identities sorted in non-decreasing order of corresponding value from \overline{B}_n . The vehicle identities at each position in $|\overline{l}_n|$ thus match the corresponding state of charge in $|\overline{B}_n|$. Every element in the ordered is assigned a rank, k , which ranges from 1 to l_n .

We then distribute the solar power in the n^{th} timestep, P_n^{PV} , among the l_n plugged in EVs. The power delivered to the i^{th} vehicle which is at the k^{th} rank at the timestep n is denoted by $P_{i,k,n}$. The power delivered per vehicle is decided according to the rank as shown in Fig. 4.8.

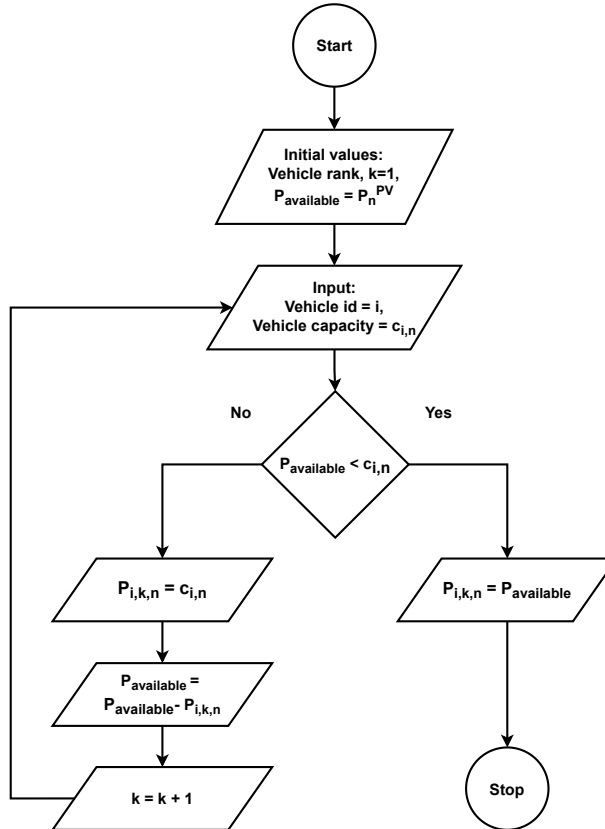

Figure 4.8: Flow per timestep for allotting power among plugged in vehicles based on rank

The procedure to establish the ranks is repeated every hour, similar to the timestep of the simulation.

4.4.1.3 *Lowest Critical Ratio priority formulation*

The next strategy assumes knowledge of the vehicle departure schedule in addition to the state of charge. As parking spots are generally reserved through an online reservation portal, large parking lot operators would typically have access to this data. Thus, vehicles which are due to leave in a few hours are treated differently than those which will remain in the parking lot for days or weeks. The indicator used in this case to

prioritise the allocation of energy is the Critical Ratio (CR). We define the critical ratio as the ratio of time remaining till departure to the battery depth of discharge.

At any time step, n , the duration of time remaining before departure for the i^{th} vehicle is $t_i^{exit} - n$. The depth of discharge, d , (in percentage) of the i^{th} vehicle at any timestep, n , is calculated as:

$$d_{i,n} = 100 - S_{i,n} \quad (4.7)$$

where $S_{i,n}$ is the state of charge of the i^{th} vehicle at the n^{th} timestep.

The depth of discharge may be considered analogous to the work still to be performed. From \overline{B}_n , the set of states of charge of plugged in vehicles, we calculate the set of depths of discharge, $\overline{d}_{i,n}$, for each of the vehicles. The critical ratio of the i^{th} vehicle in the parking lot at the n^{th} timestep, $CR_{i,n}$, is the ratio of duration of time remaining before departure to the depth of discharge:

$$CR_{i,n} = \frac{t_i^{exit} - n}{d_{i,n}} \quad \forall i \in \overline{I}_n \quad (4.8)$$

A low critical ratio thus implies that the vehicle is due to leave shortly and has a high depth of discharge while a high critical ratio implies that the vehicle will remain parked for a long duration and has a low depth of discharge.

Let $\overline{\Omega}_n$ be the set of critical ratios of all the vehicles in the parking lot at the timestep n :

$$\overline{\Omega}_n = \underbrace{\{CR_{i,n}, \dots\}}_{l_n \text{ terms}} \quad \forall i \in \overline{I}_n \quad (4.9)$$

Let $|\overline{\Omega}_n|$ be the non-decreasing ordered sequence of elements in $\overline{\Omega}_n$. Every element in the sequence is assigned a rank, k , which ranges from 1 to l_n .

We then distribute the power in the n^{th} timestep, P_n , among the l_n plugged-in EVs. The power delivered to the i^{th} vehicle which is at the k^{th} rank at the timestep n is denoted by $P_{i,k,n}$. The power delivered per vehicle is decided according to the rank k as shown in Fig. 4.8. As in the earlier cases, the procedure to establish the ranks is repeated every hour in the simulation.

4.4.2 COMPARISON OF PRIORITISED CHARGING APPROACHES

A year of system operation was then run with plugged-in EVs charged according to the three strategies:

1. 80% SoC sufficiency
2. Lowest SoC priority
3. Lowest Critical Ratio priority

We analyse the results by looking at the probability distribution of the states of charge on departure of EVs in each of the cases. These are shown in Fig. 4.9.

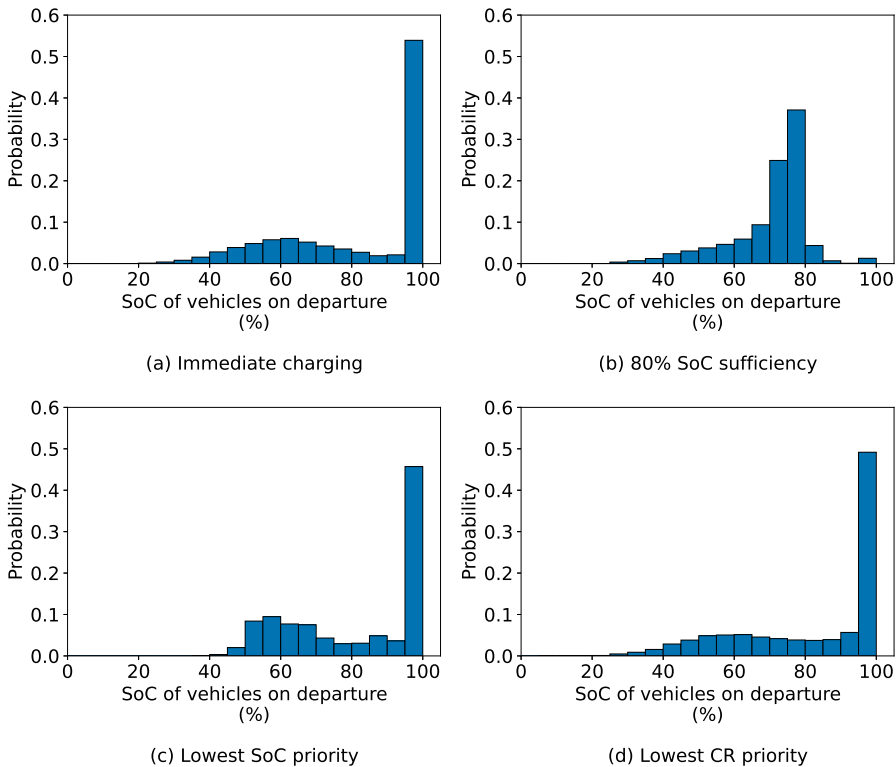

Figure 4.9: Histograms of SoC of EVs on departure in case of a) Immediate charging, b) 80% SoC sufficiency, c) Lowest SoC priority and d) Lowest Critical Ratio priority

Fig. 4.9(a) shows the reference case: the distribution vehicles by the states of charge on departure in case of immediate charging of plugged in EVs. It is characterised by a large

peak of fully charged vehicles with a smaller relatively flat distribution peaking around 60%. With the 80% SoC sufficiency, as seen in Fig. 4.9(b), the rightmost peak is shifted to the left. Very few vehicles are fully charged and a small fraction is charged to an SOC higher than 80%. The majority of vehicles are charged to between 60 and 80%. A relatively low influence is seen on vehicles leaving with SoCs lower than 60% - the distribution is similar to the base case.

In Fig. 4.9(c), where the distribution of SoCs on departure are shown with the lowest SoC priority rule, the number of fully charged vehicles is found to reduce slightly. The spread of the distribution of vehicles leaving at lower SoCs is reduced, with the peak shifting slightly leftward. A noticeable difference is the near elimination of vehicles leaving at SoCs lower than 40% with the fraction dropping to 0.03% of the total fleet. The share leaving with SoC below 60% remains relatively unchanged, but almost all these vehicles have over 50% SoC.

Finally, in Fig. 4.9(d), the case with the prioritisation of charging of vehicles with the lowest critical ratio is seen. This is found to lead primarily to an increase in the share of vehicles leaving with SoCs between 80 and 100%, with a slight reduction in the number of vehicles which are fully charged relative to the base case. There is no influence on the vehicles leaving with SoC lower than 60%. An investigation of the distribution of critical ratios over the plugged in fleet at individual timesteps revealed that vehicles at higher SoCs which were nearing the time of departure often had lower critical ratios than those at lower SoCs with more time left, and thus took precedence in charging priority.

As in section 4.3.4, we now focus on the vehicles at relatively low states of charge, shown in Fig. 4.10:

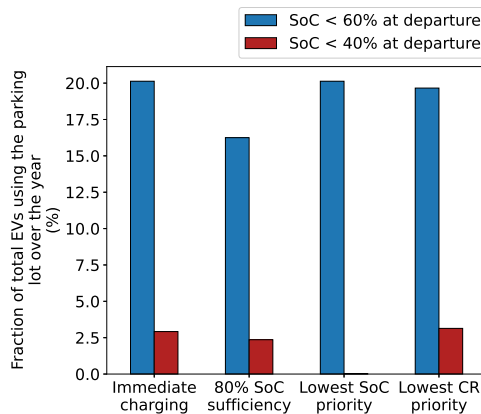
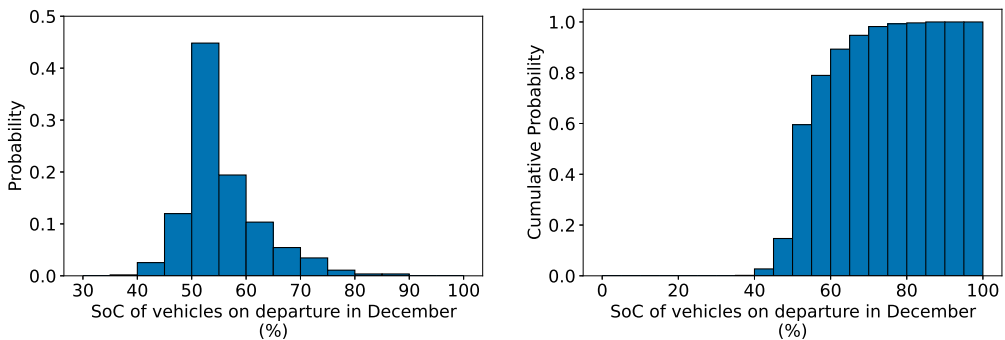

Figure 4.10: Comparison of energy allocation strategies on the fraction of EVs leaving at inadequate states of charge

As seen in Fig. 4.10, the 80% sufficiency strategy results in a reduction in the share of vehicles leaving with SoCs lower than 60% but has little effect on those leaving with SoCs lower than 40%, which are in critical need of charging. In contrast, the lowest SoC prioritising strategy effectively ensures charging to the vehicles which are in critical need of charging. The critical ratio strategy is seen to have a very low influence on the vehicles departing with low SoCs relative to the base case. The additional inclusion of the departure schedule in the strategy thus brings no added value. For a system aiming to reduce or eliminate the number of vehicles which depart at the lowest states of charge, the strategy prioritising charging of the lowest SoC is therefore recommended.

4.4.3 CRITICAL MONTH ANALYSIS WITH THE LOWEST SoC PRIORITY STRATEGY

The performance of the system in terms of adequacy of charging provided during the critical month, December, was of particular concern, as described in section 4.3.3. Having identified the best strategy for allocation of available energy (lowest SoC priority), we now analyse the performance of the system in the critical month while using this strategy. The distribution of SoCs of EVs at departure in December under the lowest SoC priority strategy are shown in Fig. 4.11(a) while Fig. 4.11(b) shows the cumulative distribution.



(a) Distribution of SoCs on departure in December
(b) Cumulative distribution of SoCs on departure in December

Figure 4.11: Distributions of SoCs on departure of EVs parking in the solar parking lot in December under lowest SoC priority charging

As seen in Fig. 4.11, nearly all vehicles depart with SoCs between 40% and 80%. No EVs are fully charged and a very small fraction - 0.2% leave with an SoC lower than 40%. Table 4.3 compares these results with those from December in the base case. A majority of EVs (79%) still leave with an SoC lower than 60%. This suggests that performance of the system during the critical month remains a challenge.

Table 4.3: Cumulative distribution of vehicles based on SoC at departure in the worst month, December: comparison of the base case with immediate charging and lowest SoC priority strategy

State of Charge at departure	Fraction of EVs in December	
	Base case	Lowest SoC Priority
<99	100%	100%
<80	97%	99%
<60	63%	79%
<40	11%	0.2%

4.4.4 COMBINED STRATEGIES

Finally, we analyse the the performance of the system under a combination of the system design approaches described in section 4.3.4 as well as the prioritised charging strategies outlined in section 4.4.1. We use the approach with the best results in each case: increased minimum parking duration and lowest SoC priority based charging. As in earlier cases, we focus on the EVs leaving at the lowest SoCs. The case with lowest SoC priority based charging is shown in Fig. 4.12(b) while Fig. 4.12(a) shows the immediate charging case for reference.

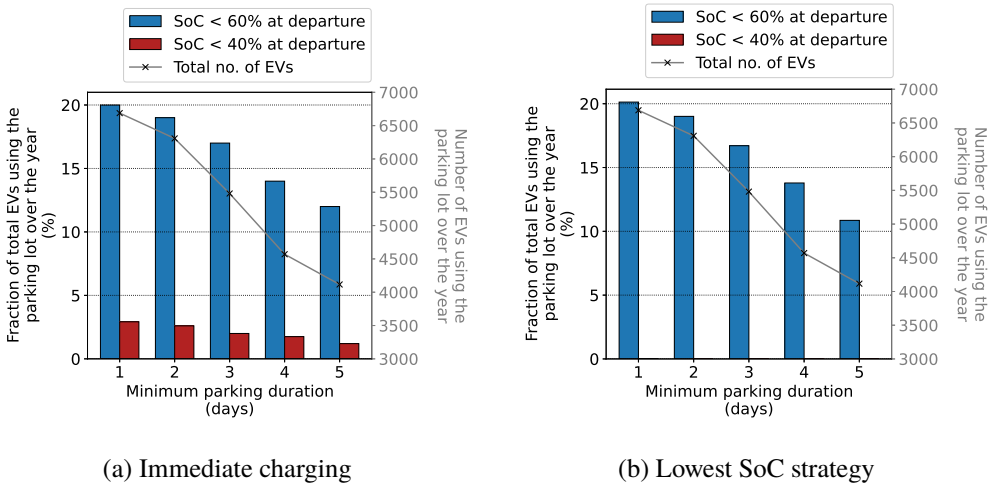

Figure 4.12: Reduction in fraction of EVs leaving at inadequate states of charge over the year due to increase in minimum parking duration: comparison of strategies

Fig. 4.12(b) shows the reduction in the share of EVs departing from the parking lot at states of charge lower than 40% and 60% with increasing minimum parking durations. The number of vehicles leaving with SoCs lower than 40% are seen to be nearly eliminated with one day as the minimum parking duration. Longer parking durations completely eliminate the vehicles departing with SoCs lower than 40% and also reduce the number of vehicles leaving at SoCs below 60%. Such a combined approach in system design would yield the best results in terms of adequate charging of EVs using the parking lot.

Although a majority of vehicles are not expected to be fully charged across all seasons, combining strategies effectively eliminates problem of vehicles leaving while still in critical need of charging.

4.4.5 COMMERCIAL APPLICATION OF OFF-GRID SOLAR PARKING LOTS FOR EV CHARGING

At locations such as airports, parking lots are commercially operated, with paid parking offered as a service. The annual revenues from parking lots can be in the range of tens to hundreds of millions of USD for medium to large airports [44]. However, the costs of electrification for such large fleets (as many as several tens of thousands of vehicles at a time) can be correspondingly high, particularly due to the high peak capacity needed. Since the typical costs of electricity paid by EV drivers are relatively low, the pay back periods for EV charging infrastructure tend to be longer than for conventional paid parking.

With increased electrification of the fleet, range anxiety of EV drivers is expected to play a role in the parking choices of increasing numbers of visitors. Availability of EV charging infrastructure at the destination is known to have a significant role in the trip planning of EV drivers [45]. Locations with insufficient or inaccessible parking are likely to be avoided by BEV drivers, shifting them to other transportation modes or even different locations. Provision of accessible public EV charging infrastructure is an established method of reducing range anxiety [3]. Solutions such as the system proposed here can help achieve ubiquitous charging by offering lower cost pathways for electrification and alternatives for locations with constrained grid capacity.

4.5 CONCLUSIONS

In this chapter, we investigate the use of a solar off-grid system for the charging of electric vehicles at long-term parking. The effectiveness of the off-grid system is studied through analysis of the states of charges at departure of the EVs plugged in at the parking lot over the simulated year. With immediate charging, we find that about half of the vehicles leave with fully charged batteries, while the rest leave at lower states of charge. Over the year,

about 20% of EVs depart with SoCs lower than 60% and about 3% with SoCs lower than 40%. These vehicles in particular are likely to have range issues for future trips. A high seasonal dependence is seen, with EVs leaving with lower SoCs mainly in winter.

Increasing the solar module efficiency had a marginal effect on the EVs leaving at the lowest SoCs. Increasing the minimum duration of stay of EVs at the parking lot was found to be more effective than increasing the module efficiency. There were limits to the effectiveness of these strategies since a fraction of EVs, albeit a small one, still departed with inadequate range.

The restriction of charging of vehicles to 80% SoC was found largely to reduce the number of fully charged vehicles, while the vehicles at lower SoCs were not greatly affected. The lowest SoC formulation was found to be far more effective at reducing the number of vehicles leaving at lowest SoCs. The lowest critical ratio, which would require the additional integration of the arrival-departure schedule with the energy system, was found to have poorer results than the lowest SoC method. We therefore identify the lowest SoC priority rule to be most effective at increasing the adequacy of charging provided by the system to vehicles.

Although the lowest SoC priority effectively reduces the numbers of vehicles leaving at the lowest SoCs, the performance of the system in the worst months remains a challenge. Combining the lowest SoC priority rule with other measures can alleviate this issue to a certain degree, but this strategy does not achieve 100% or very high SoCs for most vehicles in the winter months. The results suggest that a relatively small size of grid connection, primarily for use in winter, may however be sufficient for adequate charging of vehicles in long-term parking lots at the location considered. This can result in significant reduction in project costs, though a financial estimation of this reduced cost remains out of scope of this work.

The insights from the results obtained here can be generalised to a certain extent for application in other locations. Although irradiation profiles are site specific, the location chosen here has a relatively high latitude of 51°North. At locations closer to the Equator with higher irradiance during the critical month, a larger share of vehicles are expected to leave with higher SoCs even in winter. For parking system operators, increasing the minimum parking duration for summer and reducing them in winter can effectively be used to reduce PV curtailment in summer while retaining high performance in winter. For long-term parking lots in remote locations which are used only in summer such as those at campsites or vacation homes, off-grid solar charging can be a viable design choice even at higher latitudes.

The methods used here can also provide insights which can be used by both system designers as well as in future researcher work. The analysis of SoCs of EVs on departure can be used as a measure of utilisation and successful placement of public charging stations. Currently such studies quantify the success of charging by measuring the average daily units of electricity consumed [18]. The various strategies analysed and

compared here can all be applied in future system design. New priority formulations can also use data like the expected driving range per vehicle if such data is provided by the EV drivers.

REFERENCES

-
- [1] Abergel, T. *Global EV Outlook 2020*. Paris, France: International Energy Agency (IEA), 2020, p. 276.
- [2] Hawkins, T. R., Singh, B., Majeau-Bettez, G., Strømman, A. H., “Comparative Environmental Life Cycle Assessment of Conventional and Electric Vehicles.” In: *Journal of Industrial Ecology* 17.1 (2013), pp. 53–64. ISSN: 3-936338-34-5. DOI: 10.4229/EUPVSEC20142014-5DV.3.46. URL: <https://onlinelibrary.wiley.com/doi/abs/10.1111/j.1530-9290.2012.00532.x>.
- [3] Hall, D., Lutsey, N., *Emerging best practices for electric vehicle charging infrastructure*. Washington DC, USA: The International Council on Clean Transportation, 2017, p. 54. URL: https://theicct.org/sites/default/files/publications/EV-charging-best-practices_ICCT-white-paper_04102017_vF.pdf.
- [4] Nicholas, M. *Estimating electric vehicle charging infrastructure costs across major U.S. metropolitan areas*. Washington DC, USA: International Council on Clean Transportation, 2019, p. 11. URL: https://theicct.org/sites/default/files/publications/ICCT_EV_Charging_Cost_20190813.pdf.
- [5] Blok, R. *Verslag Benchmark Publiek laden 2018 - Sneller naar een volwassenes markt*. Nationaal Kennisplatform Laadinfrastructuur, 2018. URL: https://www.nklnederland.nl/uploads/files/Verslag_Benchmark_Publiek_Laden_2018_-_Sneller_naar_een_volwassen_markt_FINAL.pdf.
- [6] Birnie, D. P. “Solar-to-vehicle (S2V) systems for powering commuters of the future.” In: *Journal of Power Sources* 186.2 (2009), pp. 539–542. ISSN: 03787753. DOI: 10.1016/j.jpowsour.2008.09.118. URL: <http://linkinghub.elsevier.com/retrieve/pii/S0378775308018946>.
- [7] Denholm, P., Kuss, M., Margolis, R. M., “Co-benefits of large scale plug-in hybrid electric vehicle and solar PV deployment.” In: *Journal of Power Sources* 236 (2013), pp. 350–356. ISSN: 03787753. DOI: 10.1016/j.jpowsour.2012.10.007. URL: <http://linkinghub.elsevier.com/retrieve/pii/S0378775312015534>.
- [8] Erickson, L. E., Burkey, A., Morrissey, K. G., Reynolds, M., Robinson, J., Ronnebaum, B., Wagner, T., Singh, P., Natarajan, B., Pahwa, A., “Social, economic, technological, and environmental impacts of the development and implementation of solar-powered charge stations.” In: *Environmental Progress & Sustainable Energy* 34.6 (2015), pp. 1808–1813. ISSN: 1944-7450. DOI: 10.1002/ep.12163. URL: <http://onlinelibrary.wiley.com/doi/abs/10.1002/ep.12163>.
- [9] Goldin, E., Erickson, L., Natarajan, B., Brase, G., Pahwa, A., “Solar powered charge stations for electric vehicles.” In: *Environmental Progress & Sustainable Energy* 33.4 (2014), pp. 1298–1308. ISSN: 1944-7450. DOI: 10.1002/ep.11898. URL: <http://onlinelibrary.wiley.com/doi/abs/10.1002/ep.11898>.
- [10] Nunes, P., Figueiredo, R., Brito, M. C., “The use of parking lots to solar-charge electric vehicles.” In: *Renewable and Sustainable Energy Reviews* 66 (2016), pp. 679–693. ISSN: 13640321. DOI: 10.1016/j.rser.2016.08.015. URL: <http://linkinghub.elsevier.com/retrieve/pii/S1364032116304294>.
- [11] Figueiredo, R., Nunes, P., Brito, M. C., “The feasibility of solar parking lots for electric vehicles.” In: *Energy* 140 (2017), pp. 1182–1197. ISSN: 03605442. DOI: 10.1016/j.energy.2017.09.024. URL: <http://linkinghub.elsevier.com/retrieve/pii/S0360544217315438>.
- [12] Tong, S. J., Same, A., Kootstra, M. A., Park, J. W., “Off-grid photovoltaic vehicle charge using second life lithium batteries: An experimental and numerical investigation.” In: *Applied Energy* 104 (2013), pp. 740–750. ISSN: 0306-2619. DOI: 10.1016/j.apenergy.2012.11.046. URL: <http://www.sciencedirect.com/science/article/pii/S0306261912008495>.
- [13] Bhatti, A. R., Salam, Z., Aziz, M. J. B. A., Yee, K. P., Ashique, R. H., “Electric vehicles charging using photovoltaic: Status and technological review.” In: *Renewable and Sustainable Energy Reviews* 54 (2016), pp. 34–47. ISSN: 1364-0321. DOI: 10.1016/j.rser.2015.09.091. URL: <http://www.sciencedirect.com/science/article/pii/S1364032115010618>.
- [14] Chandra Mouli, G., Bauer, P., Zeman, M., “System design for a solar powered electric vehicle charging station for workplaces.” In: *Applied Energy* 168 (2016), pp. 434–443. ISSN: 03062619. DOI: 10.1016/j.apenergy.2016.01.110. URL: <http://linkinghub.elsevier.com/retrieve/pii/S0306261916300988>.

- [15] Mehrjerdi, H. "Off-grid solar powered charging station for electric and hydrogen vehicles including fuel cell and hydrogen storage." In: *International Journal of Hydrogen Energy* 44.23 (2019), pp. 11574–11583. ISSN: 0360-3199. DOI: 10.1016/j.ijhydene.2019.03.158. URL: <http://www.sciencedirect.com/science/article/pii/S0360319919311668>.
- [16] Wang, Y., Kazemi, M., Nojavan, S., Jermittiparsert, K., "Robust design of off-grid solar-powered charging station for hydrogen and electric vehicles via robust optimization approach." In: *International Journal of Hydrogen Energy* 45.38 (2020), pp. 18995–19006. ISSN: 0360-3199. DOI: 10.1016/j.ijhydene.2020.05.098. URL: <http://www.sciencedirect.com/science/article/pii/S0360319920318796>.
- [17] Psaraki, V., Stathopoulos, A., Abakoumkin, C., "Parking Capacity Requirements for Relocated Airports: The New Athens International Airport." In: *Transportation Research Record: Journal of the Transportation Research Board* 1788.1 (2002), pp. 19–25. ISSN: 0361-1981, 2169-4052. DOI: 10.3141/1788-03. URL: <http://journals.sagepub.com/doi/10.3141/1788-03>.
- [18] Van Montfort, K., Kooi, M., Van der Poel, G., Van den Hoed, R., "Which factors influence the success of public charging stations of electric vehicles?" In: *6th Hybrid and Electric Vehicles Conference (HEVC 2016)*. 6th Hybrid and Electric Vehicles Conference (HEVC 2016). London, UK: Institution of Engineering and Technology, 2016, 11 (5.)–11 (5.) ISBN: 978-1-78561-294-7. DOI: 10.1049/cp.2016.0971. URL: <https://digital-library.theiet.org/content/conferences/10.1049/cp.2016.0971>.
- [19] Savari, G. F., Krishnasamy, V., Sugavanam, V., Vakesan, K., "Optimal Charging Scheduling of Electric Vehicles in Micro Grids Using Priority Algorithms and Particle Swarm Optimization." In: *Mobile Networks and Applications* 24.6 (2019), pp. 1835–1847. ISSN: 1572-8153. DOI: 10.1007/s11036-019-01380-x. URL: <https://doi.org/10.1007/s11036-019-01380-x>.
- [20] Aveklouris, A., Vlasiou, M., Zwart, B., "Bounds and limit theorems for a layered queueing model in electric vehicle charging." In: *Queueing Systems* 93.1 (2019), pp. 83–137. ISSN: 1572-9443. DOI: 10.1007/s11134-019-09616-z. URL: <https://doi.org/10.1007/s11134-019-09616-z>.
- [21] Li, J., "Quantitative analysis of automobile parking at airports." Master thesis. Ottawa, Canada: University of Calgary, 2009. URL: <http://dx.doi.org/10.11575/PRISM/3246> (visited on 12/01/2021).
- [22] NEN, *NEN 2443: Parkeren en stallen van personenauto's op terreinen en in garages*. NEN 2443:2000. Delft, the Netherlands: Nederlands Normalisatie Instituut, 2013.
- [23] REC, *REC N-Peak Black Series*. 2020. URL: https://www.recgroup.com/sites/default/files/documents/ds_rec_n-peak_black_series_iec_rev_d_en_web.pdf (visited on 05/29/2020).
- [24] SMA, *Sunny Central Storage 1900 / 2200 / 2475 / 2900 datasheet*. 2020. URL: <https://files.sma.de/downloads/SCS1900-2900-DS-en-14.pdf>.
- [25] European Commission Joint Research Centre (JRC), *Photovoltaic Geographical Information System (PVGIS)*. 2020. URL: https://re.jrc.ec.europa.eu/pvg_tools/en/tools.html.
- [26] Holmgren, W., Hansen, C., Mikofski, M., "pvlib python: a python package for modeling solar energy systems." In: *Journal of Open Source Software* 3.29 (2018), p. 884. ISSN: 2475-9066. DOI: 10.21105/joss.00884. URL: <https://joss.theoj.org/papers/10.21105/joss.00884>.
- [27] Apostolaki-Iosifidou, E., Codani, P., Kempton, W., "Measurement of power loss during electric vehicle charging and discharging." In: *Energy* 127 (2017), pp. 730–742. ISSN: 03605442. DOI: 10.1016/j.energy.2017.03.015. URL: <https://linkinghub.elsevier.com/retrieve/pii/S0360544217303730>.
- [28] *EV Database*. EV Database. Library Catalog: ev-database.nl. URL: <https://ev-database.nl/> (visited on 05/15/2020).
- [29] Netherlands Enterprise Agency, *Statistics Electric vehicles in the Netherlands up to and including February 2020*. 2020. URL: https://www.rvo.nl/sites/default/files/2019/03/2019_02_Statistics%20Electric%20Vehicles%20and%20Charging%20in%20The%20Netherlands%20up%20to%20and%20including%20February%202019.pdf (visited on 04/09/2020).
- [30] Francfort, J. "EV Project Data and Analytic Results." 2014 DOE Vehicle Technologies Office Review. Idaho Falls, USA, 2014. URL: https://www.energy.gov/sites/prod/files/2014/07/f18/vss137_francfort_2014_o.pdf.

- [31] Ochoa, L. F. *Intelligent Control of EVs: Lessons Learned from the Largest UK EV Trial*. Manchester, UK: University of Manchester, 2015. URL: <http://myelectricavenue.info/sites/default/files/My%20Electric%20Avenue%20Webinar%20May%202015.pdf>.
- [32] Speidel, S., Bräunl, T., “Driving and charging patterns of electric vehicles for energy usage.” In: *Renewable and Sustainable Energy Reviews* 40 (2014), pp. 97–110. ISSN: 13640321. DOI: 10.1016/j.rser.2014.07.177. URL: <http://linkinghub.elsevier.com/retrieve/pii/S1364032114006297>.
- [33] Franke, T., Krems, J. F., “Understanding charging behaviour of electric vehicle users.” In: *Transportation Research Part F: Traffic Psychology and Behaviour* 21 (2013), pp. 75–89. ISSN: 13698478. DOI: 10.1016/j.trf.2013.09.002. URL: <https://linkinghub.elsevier.com/retrieve/pii/S1369847813000776>.
- [34] Manwell, J. F., McGowan, J. G., “Extension of the Kinetic Battery Model for Wind/Hybrid Power Systems.” In: *Proceedings of the 5th European Wind Energy Association Conference (EWEC '94)*. Thessaloniki, Macedonia, Greece., 1994, pp. 1182–1187.
- [35] Lilienthal, P. *HOMER Pro*. Version 3.7. Boulder, Colorado, USA, 2016. URL: <https://www.homerenergy.com/pdf/HOMERHelpManual.pdf> (visited on 06/19/2018).
- [36] Jongerden, M. R., Haverkort, B. R., “Which battery model to use?” In: *IET Software* 3.6 (2009), pp. 445–457. ISSN: 1751-8806. DOI: 10.1049/iet-sen.2009.0001.
- [37] DiOrio, N., Dobos, A., Janzou, S., Nelson, A., Lundstrom, B., *Technoeconomic Modeling of Battery Energy Storage in SAM*. NREL/TP-6A20-64641. Golden, CO (United States): National Renewable Energy Laboratory (NREL), 2015. DOI: 10.2172/1225314. URL: <http://www.osti.gov/servlets/purl/1225314/>.
- [38] Ashford, N. J., Mumayiz, S., Wright, P. H., *Airport Engineering: Planning, Design, and Development of 21st Century Airports*. New York, United States: John Wiley & Sons, Incorporated, 2011. ISBN: 978-1-118-00529-3. URL: <https://ebookcentral.proquest.com>.
- [39] Straker, I. “Airport carparking strategy: lessons from the non-airport sector.” PhD thesis. Loughborough, England: Loughborough University, 2006. URL: <https://dspace.lboro.ac.uk/dspace-jspui/bitstream/2134/2296/4/Thesis-2006-Straker.pdf>.
- [40] Young, S. B., Wells, A., *Airport planning and management*. 6th ed. OCLC: ocn659764130. New York: McGraw-Hill, 2011. 588 pp. ISBN: 978-0-07-175024-0.
- [41] Philipps, S., Warmuth, W., *Fraunhofer ISE: Photovoltaics Report*. Freiburg, Germany: Fraunhofer Institute for Solar Energy Systems, 2020, p. 48. URL: <https://www.ise.fraunhofer.de/content/dam/ise/de/documents/publications/studies/Photovoltaics-Report.pdf>.
- [42] Qin, H., Gao, J., Zhang, G., Chen, Y., Wu, S., “Nested logit model formation to analyze airport parking behavior based on stated preference survey studies.” In: *Journal of Air Transport Management* 58 (2017), pp. 164–175. ISSN: 0969-6997. DOI: 10.1016/j.jairtraman.2016.10.011. URL: <http://www.sciencedirect.com/science/article/pii/S0969699716300588>.
- [43] Heather, M. J., Edge, D. J., “Manchester Airport Terminal 2: Terminal Infrastructure.” In: *Proceedings of the Institution of Civil Engineers - Transport* 105.3 (1994), pp. 21–30. ISSN: 0965-092X, 1751-7710. DOI: 10.1680/itrans.1994.25704. URL: <http://www.icevirtuallibrary.com/doi/10.1680/itrans.1994.25704>.
- [44] Wadud, Z. “An examination of the effects of ride-hailing services on airport parking demand.” In: *Journal of Air Transport Management* 84 (2020), p. 101783. ISSN: 0969-6997. DOI: 10.1016/j.jairtraman.2020.101783. URL: <http://www.sciencedirect.com/science/article/pii/S0969699719302108>.
- [45] Ashkrof, P., Homem de Almeida Correia, G., Arem, B., “Analysis of the effect of charging needs on battery electric vehicle drivers’ route choice behaviour: A case study in the Netherlands.” In: *Transportation Research Part D: Transport and Environment* 78 (2020), p. 102206. ISSN: 1361-9209. DOI: 10.1016/j.trd.2019.102206. URL: <http://www.sciencedirect.com/science/article/pii/S1361920919309757>.

OFFSETTING EMISSIONS AT SOLAR CARPARKS FOR EV CHARGING

Abstract

This chapter analyses a recently constructed solar carpark located in Dronten, the Netherlands, which includes a solar array, a nickel metal hydride battery and charge points for electric vehicle charging. The aim of the study is to quantify the magnitude of offset carbon emissions per year by the solar carport, and the contribution of battery storage to this offset. The prevalent practice of using the annual average carbon intensity is found to be unsuitable for estimating the annual offset carbon emissions since it does not account for the intra-day patterns of solar production, EV charging and battery cycling. To overcome this, we propose a novel method to calculate the annual offset carbon emissions, making use of the hourly average and hourly marginal carbon intensity. The choice of approach is found to make a difference to the calculated values of the annual offset emissions of the solar carpark. The use of the hourly average carbon intensity, which takes into account variation in production, generation and storage, leads to a higher calculated value of annual offset carbon emissions by about 7% relative to a method using the annual average carbon intensity. The use of the hourly marginal carbon intensity to calculate the annual offset carbon emissions suggests that solar carparks have about a 55% higher incremental effect on the carbon intensity associated with the new load of EV charging than what is conventionally calculated. When comparing the annual offset carbon emissions from the solar carpark with and without a battery, we find that the use of the battery has a negligible effect on the annual carbon offset by the system. This result is found to be robust across all the methods of calculation. We therefore conclude that the use of batteries in solar carparks have a low contribution to the total carbon offset by the solar carport. With further increase in the share of variable renewable energies in the grid, we expect this low contribution to further decrease.

5.1 INTRODUCTION

In order to comply with climate-driven policy targets, there is a broad drive towards the electrification of passenger vehicles. As an example, in the EU,

1. In 2019, a fleet-wide target of $95 \text{ gCO}_2/\text{km}$ was set for the average emissions of new passenger vehicles registered in the EU from 1st January 2020 [1, 2].
2. The regulations for fleetwide emissions have been strengthened, with new legislation permitting only the sale of ZLEVs¹ after 2035 [3, 4].

Based on EU legislation, emissions from all newly registered vehicles were measured according to the laboratory based New European Driving Cycles (NEDC) protocol until 2017. Since 2017, newly registered passenger vehicles (classified in the EU as M1 category vehicles) have been required to follow the Worldwide harmonised Light-vehicle Test Procedure (WLTP), which is also the basis for fleet-wide emissions targets.

Fig. 5.1 shows the distribution of the average CO_2 emissions per kilometre of all the newly registered passenger vehicles in the EU27, UK, Norway and Iceland in 2020, as published by the European Environment Agency [5]. Under the WLTP based system of emission measurement, Battery Electric Vehicles (BEVs) have zero tailpipe or Tank-to-Wheel (TTW) emissions and can be classified as ZLEVs.

The WLTP measures tailpipe emissions under controlled laboratory conditions which are designed to be representative of '*real world driving conditions*'. However, tailpipe emissions do not reflect the total emissions over the vehicle's lifecycle, since they do not consider emissions over the material production, manufacturing, maintenance, Well-to-Tank (WTT) and end-of-life phases [6].

For BEV which operate today, the largest share of emissions occurring over the lifecycle of the vehicle are emitted during the Well-to-Tank phase i.e. the emissions associated with the electricity used for charging [6–8]. Solar carparks for EV charging can reduce the emissions associated with electric mobility over this phase. Altering the charging profile at the solar carpark through scheduled charging or the use of stationary batteries can also potentially increase the emissions offset by these systems. However, these emissions associated with charging and demand profile changes cannot be measured through laboratory procedures since the scope of the system considered includes the broader electricity grid within which EV charging occurs. The greenhouse gas emissions occur at powerplants located far away from the physical location of the charging of vehicles and the grid mix differs by both location as well as over time.

¹ ZLEVs are defined as passenger vehicles with tailpipe emissions lower than $50 \text{ gCO}_2/\text{km}$ [1]

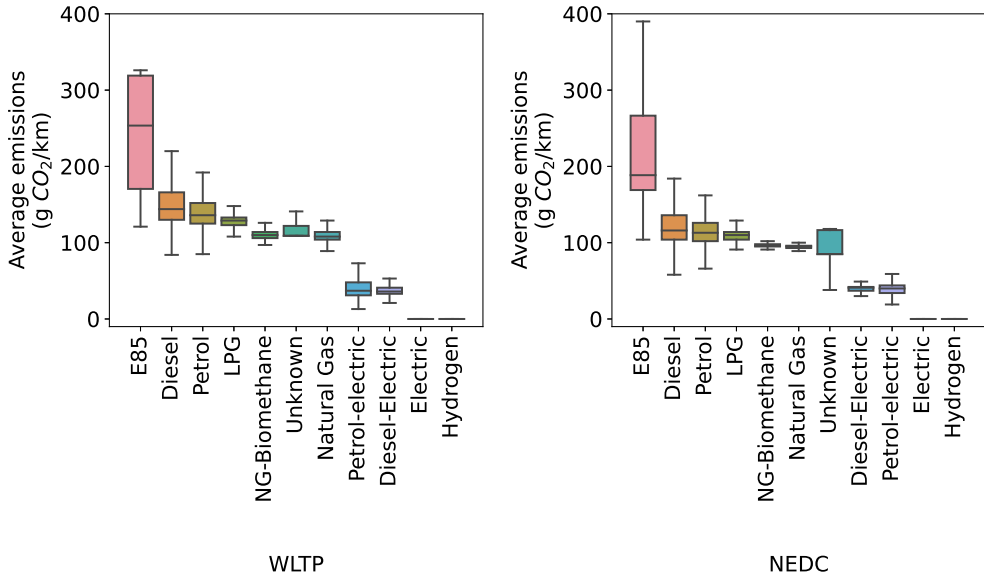

Figure 5.1: Average emissions per kilometre of all newly registered vehicles in the EU27, UK, Norway and Iceland in 2020. The values are disaggregated by fuel type and by the emission testing procedure (Source: European Environment Agency [5]).

Note: The horizontal lines within each box show the median value. The top and bottom of the box represent the 25th and 75th percentile values. The whiskers show the outermost datum within 1.5 times the interquartile range, beyond which values are considered outliers, and are not shown.

The research questions posed in this chapter are ‘*What is the magnitude of annual carbon emissions caused by a solar carpark with storage for EV charging?*’ and ‘*How does the change in the electricity demand profile due to battery charging and discharging affect the annual carbon emissions associated with the electricity use of the solar carpark?*’

This chapter is structured as follows: section 5.2 describes the solar carpark analysed and how it is modelled. In section 5.3, we describe the theory and the methods we develop to estimate carbon emissions and offset carbon emissions as well as the data used. In section 5.4, we outline the results of the study and discuss them in the context of existing literature. Finally in section 5.5, we present our conclusions.

5.2 SOLAR CARPARK SYSTEM DESCRIPTION

We analyse a solar carpark for EV charging located at the Municipality building at Dronten, the Netherlands (see Fig 5.3(a)). The solar carpark includes various components working together, including solar PV arrays, a stationary battery and EV charging stations. Detailed descriptions of the system, the modelling of each of the subsystems, the data used from outside the system as well as the simulation of operation of the solar carpark system are provided below.

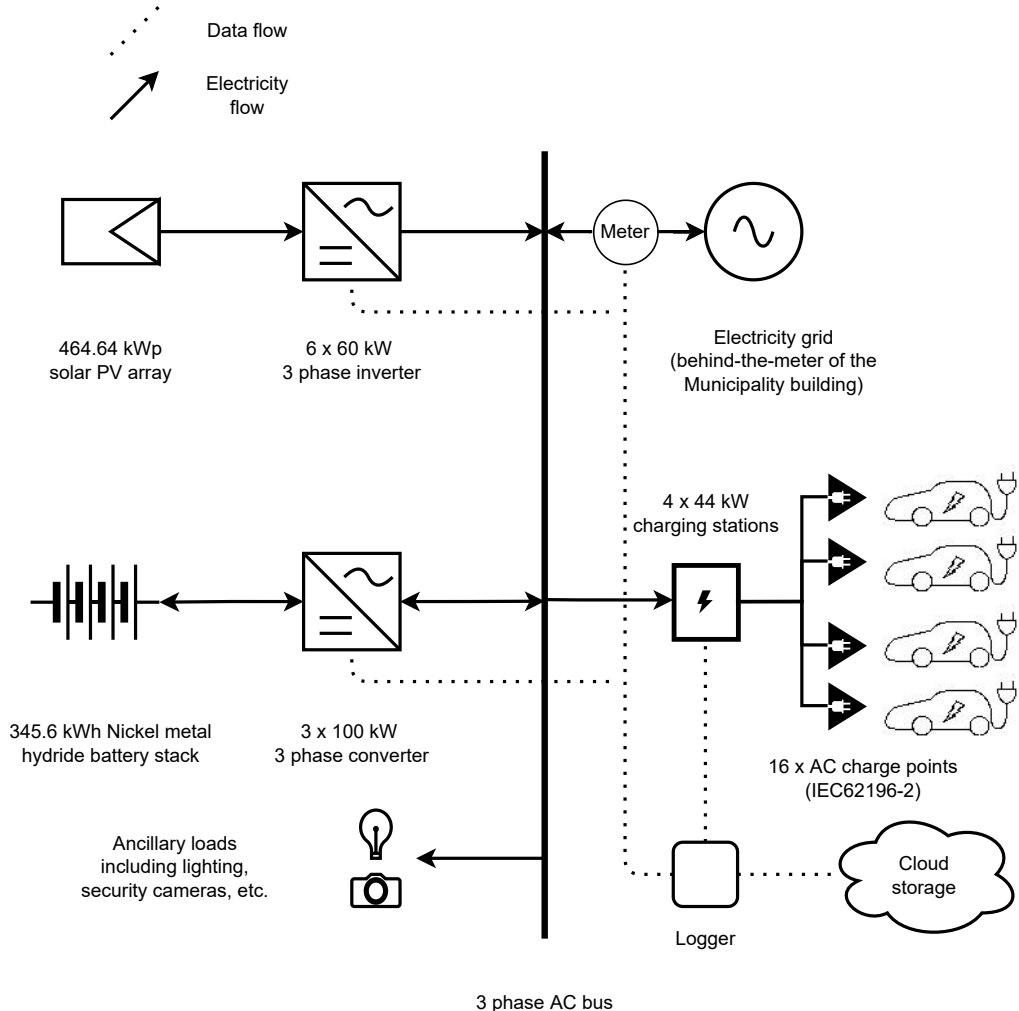

Figure 5.2: Schematic of the solar parking lot for EV charging at the project site in Dronten, the Netherlands

5.2.1 SOLAR CARPARK SYSTEM

The solar carpark analysed is used for parking both ICE vehicles as well as for charging EVs belonging to the municipality staff and visitors. Solar modules were mounted on steel carports at the parking lot, shading the vehicles parked underneath. A battery was located in a storage container under one of the carports, while the parking spaces located adjacent to the 16 charge points were reserved for EVs. A schematic of the electrical layout at the parking lot is shown in Fig. 5.2 while Fig 5.3(a) shows a photograph of the installation.

5.2.2 SOLAR ARRAY

Solar arrays were mounted facing east and west on three rows of duopitch T-frame solar carports, as shown in Fig. 5.3(a). Bifacial modules manufactured by Ulica Solar were used to harvest light from both the top and the bottom roof surfaces. Six Huawei solar inverters were used to convert the yield from the 465 kWp installed PV capacity to 3 phase AC. Details of the solar PV arrays and inverters are provided in Table 5.1.

Table 5.1: Solar array and inverter characteristics

Characteristic	Value
Site location	Dronten, the Netherlands (52.5° N, 5.7° E)
Number of parking spaces	150
Area per parking space	~15 m ²
Module technology	Monocrystalline silicon half-cut bifacial PERC [9]
Module rating	440 Wp
Module efficiency	19.92%
Total installed capacity	464.64 kWp
Array orientation	Half east, half west, 10° tilt
Number of inverters	6
Inverter efficiency (European)	>98.5% [10]



(a) PV array at the solar parking lot located at the municipality building of Dronten, the Netherlands (b) Charging station with 4 charge points

Figure 5.3: Solar array and electric vehicle supply equipment

The operation of the solar array is simulated using System Advisor Model (SAM) version 2020.2.29. The meteorological data is sourced from the European METEOSAT satellite through the Photovoltaic Geographical Information System (PVGIS) tool [11] as a TMY file. The photovoltaic array performance is simulated using the CEC Performance Model, as described in [12, 13], with inputs provided based on the module and inverter datasheets. Table 5.2 describes the annual performance of the PV array while Fig. 5.4(a) shows the simulated annual profile of PV production at the location over a year.

Table 5.2: Solar photovoltaic production annual values

Characteristic	Value
Annual energy yield	400 MWh
Capacity Factor	9.8%

5.2.3 EV SUPPLY EQUIPMENT

Although the PV system covered an area of 150 parking spaces, only 16 of them were reserved for EV charging. Four Alfen Quattro charging stations, each with four IEC 62196-2 Type 2 AC charge points, were placed adjacent to the central T-frame columns so as to be accessible to four vehicles simultaneously. Table 5.3 provides details of the charging stations while Fig. 5.3(b) shows a charging station with a single EV plugged in.

Table 5.3: Electric vehicle charging characteristics

Characteristic	Value
Number of charging stations	4
Charge points per charging station	4
Total number of charge points	16
Charge point type	IEC 62196-2
Charging station power rating	44kW 3 phase
Charging station current rating	32A per phase

Statistics on immediate (unscheduled) electric vehicle charging at public locations in the Netherlands, including charging times, durations and energy consumption, disaggregated by weekdays and weekends were published by ElaadNL as an open dataset [14]. These statistics are used to simulate a charging profile for the 16 charge points at the location using Monte Carlo methods. Variation in charging patterns due to seasonal holidays are not taken into account. Fig. 5.4(b) shows the annual profile of all the EV charging at the location over a year, while Table 5.4 describes the EV energy demand. As a result of only 16 charging points being provided in a parking space for 150 vehicles, both peak EV power demand as well as total annual energy demand are lower than the solar peak power production and annual solar energy production respectively.

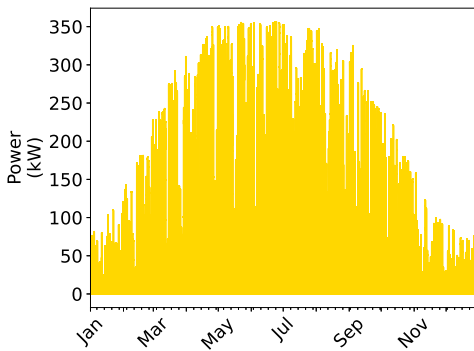

(a) Solar power production

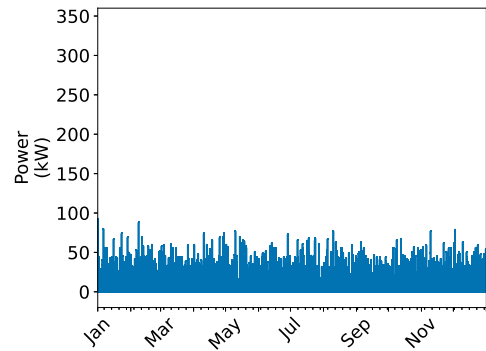

(b) EV charging power demand

Figure 5.4: Solar power production and EV charging power profile over a year at the solar carpark

Table 5.4: Electric vehicle charging demand annual values

Characteristic	Value
Total annual energy demand	64 MWh
Mean annual energy demand per charge point	4 MWh
Mean daily energy demand per charge point	11 kWh

5.2.4 NICKEL METAL HYDRIDE BATTERY

A 345.6 kWh nickel metal hydride (NI-MH) battery manufactured by Nilar² was placed within a storage container under the carports. It consisted of 6 battery cabinets, each containing rack-mounted battery packs and having a storage capacity of 57.6 kWh. Three Socomec Sunsys PCS² converters of 100 kW power capacity each were used to convert power for battery charging and discharging. Further details on the battery and inverter specifications are provided in Table 5.5 while Figs. 5.5(a) and 5.5(b) show the battery housing and cabinets respectively.

Table 5.5: Nickel metal hydride battery and battery inverter characteristics [15–17]

Characteristic	Value
Total storage capacity	345.6 kWh
Number of battery cabinets	6
Battery nominal voltage	576 V
Positive electrode	Nickel hydroxide
Negative electrode	Hydrogen absorbing metal alloy
Electrolyte	KOH water solution
Cell geometry	Prismatic
Temperature range	Operational -10° C to +40° C Optimal +10° C to +30° C
Self-discharge rate at 20° C (from fully charged state)	6% after 1 day 13% after 28 days

² for further details on the Swedish battery manufacturer, Nilar, refer www.nilar.com



(a) Battery housing located under the carport roofs (b) Battery cabinets within the housing

Figure 5.5: Nickel metal hydride battery housing in the solar parking lot in Dronten

The nickel metal hydride battery is modelled with the modified Kinetic Battery Model (KiBaM) [18]. For time series energy system modelling, the KiBaM is a commonly applied battery model, widely used in both commercial modelling tools [19, 20] and in academia [21]. It is an analytical battery model based on chemical kinetics, used to approximate charging and discharging behaviour with relative accuracy. The values from the Nilar battery datasheets were used as inputs for the KiBaM.

5.2.5 NICKEL METAL HYDRIDE BATTERY DISPATCH AND SYSTEM OPERATION

Power profiles with hourly resolution are simulated over a year for the power generation from the PV system and the power demand for EV charging. Over this year, the operation of the Ni-MH battery is simulated based on the dispatch algorithm provided in Fig. 5.6. The KiBaM is used to calculate the operational parameters such as battery voltage, current and SoC in each time step. Similar dispatch algorithms may be found in previous literature on solar carparks such as [22, 23].

For any given hourly time step, n , within the 8760 hours in the simulated year, the power with which the battery is charged, $P_n^{Bat_charge}$, or discharged, $P_n^{Bat_discharge}$, is based on whether solar power, P_n^{PV} , is available at the time step, n , after meeting the power demand from the vehicles, P_n^{EV} , as well as on the battery SoC in the same timestep. If the battery remains below 60% SoC for 24 hours, the grid is also used to charge the battery to increase battery utilisation. At each time step, the power balance with the considered electrical system is used to calculate the power that is fed in to the grid, $P_n^{Grid_feedin}$, or purchased from it, $P_n^{Grid_purchase}$.

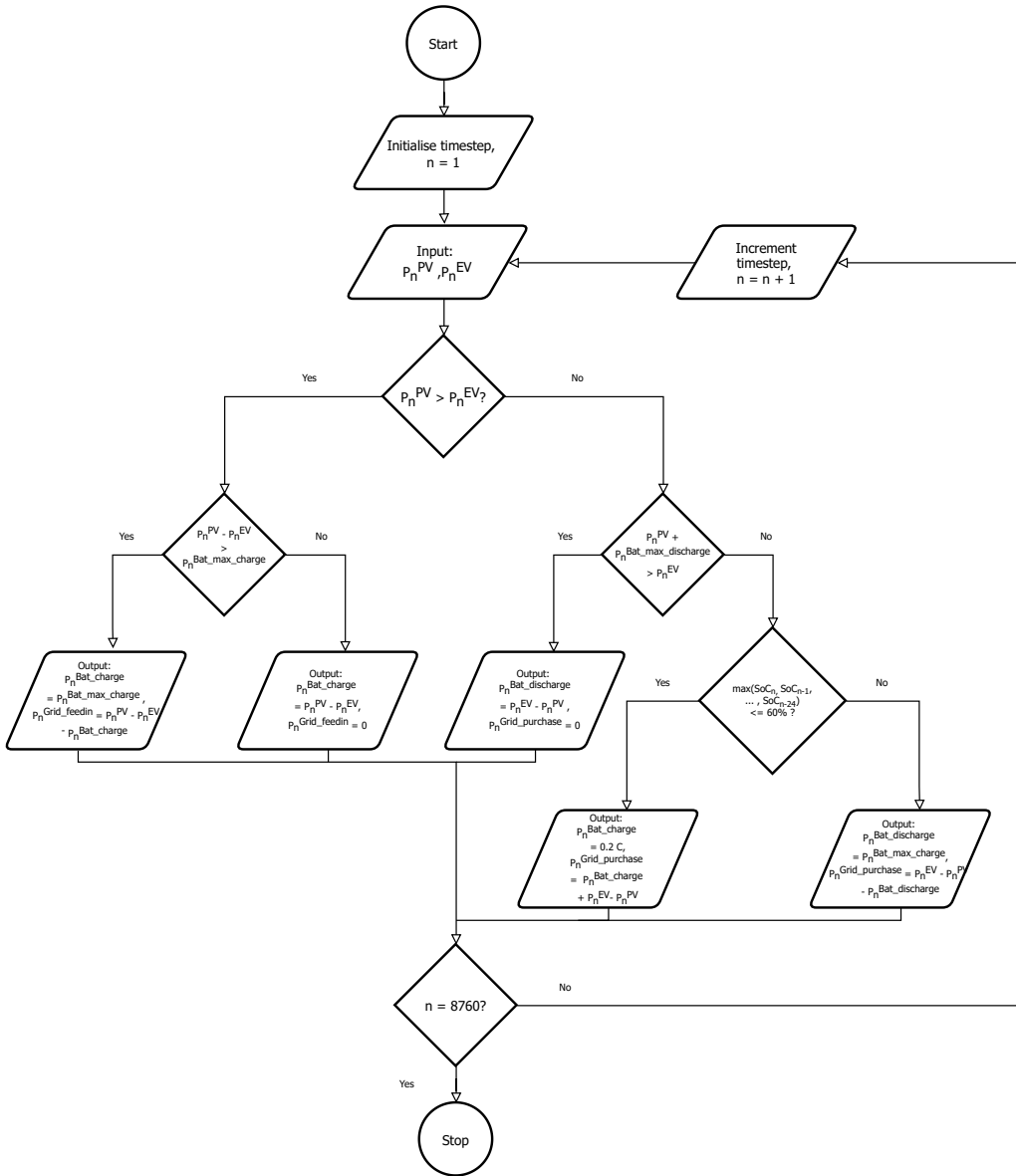

Figure 5.6: Battery dispatch algorithm over the simulation

5.3 THEORY, METHODS AND GREENHOUSE GAS DATA

There is considerable literature on the best approach for calculating the emissions impact of a given electrical power system. These differ considerably in the definition of the system, the scope and size of the study, the objective of the analysis, availability of data and so on.

In the following sections, we describe various methods found in literature which informed our study and the final adopted methodology.

5.3.1 DEFINITIONS AND SCOPE

In this study, we calculate the annual carbon emissions and the annual offset carbon emissions of the solar carpark for EV charging.

The annual carbon emissions are ‘*an estimation of the greenhouse gas (GHG) emissions that are caused by the energy system over a single representative year*’. In this study, the analysed energy system includes the solar array, the stationary metal hydride battery and the EV charging stations described in section 5.2. We consider the electric vehicles themselves outside our system boundary since they are not a result of the project involving the energy system, but rather belong to the users of the parking lot at the project location³.

On the other hand, the annual offset carbon emissions quantifies “*the difference between the annual carbon emissions of the energy system and those that would occur in a reference scenario over the same duration*”[24]. Offset emissions are thus a measure of the impact of the project activity in terms of GHG avoidance⁴. The reference scenario chosen in our case is the charging of EVs from the grid at the same location. We consider behavioural change such as EV adoption and mode shifts resulting from the construction of the solar carpark out of the scope of this study.

We analyse both scope 1 and scope 2 emissions, as defined in the Greenhouse Gas Protocol [25]. Scope 1 emissions include the emissions from owned or controlled processes, such as PV generation and battery storage. Scope 2 emissions cover the emissions associated with electricity purchased during operation. For both scope 1 and scope 2 emissions, we consider the entire lifecycle of the processes from extraction of resources through operation to final recycling and disposal. We do not consider scope 3 emissions, which include the emissions associated with purchased materials, goods and services which are not directly used in processes. As an example, emissions associated with the steel carport structures and construction work are not considered in this work. An overview of the scope of the system considered is provided in Table. 5.6.

³ The users of the parking lot were assumed to drive EVs before the project and would need to charge their vehicles regardless of the project. In reality, the availability of charging facilities at the location may result in mode shifts i.e. some users might transition from Internal Combustion Engine (ICE) vehicles to PEVs due to the increased convenience of charging. However, for the purposes of this investigation, we do not consider these mode shifting effects.

⁴ Offset carbon emissions are sometimes known as *GHG avoidance*, as in [24]

Table 5.6: Overview of the scope of emissions considered in this study. The section within the system boundaries is shown in blue

	SCOPE 1 EMISSIONS (Owned and controlled processes - PV generation and battery storage)	SCOPE 2 EMISSIONS (Purchased electricity)	SCOPE 3 EMISSIONS (Purchased goods and services)
UPSTREAM EMISSIONS (extraction, production and transportation)	<i>PV module and battery manufacture</i>	<i>Power plant construction and fuel production to generate electricity in the grid mix</i>	<i>Steel structure manufacture, construction and associated transport</i>
OPERATIONAL EMISSIONS (over project lifetime)	<i>PV module and battery operation</i>	<i>Power plant operation to generate electricity in the grid mix including transmission and distribution losses</i>	<i>Transmission and distribution losses of electricity sold to the grid</i>
DOWNSTREAM EMISSIONS (transportation and disposal)	<i>PV module and battery recycling/disposal</i>	<i>Decommissioning of power plants within the grid mix</i>	<i>Operations of investments made with revenues earned</i>

5.3.2 MARKET BASED AND LOCATIONAL METHODS FOR EMISSIONS ACCOUNTING

When electricity is purchased from the public grid, it is not possible to physically trace the production source to any specific powerplant or group of powerplants. As such, for carbon accounting of the grid electricity consumed (and metered) at a given location, there are two widely used approaches. The first approach is the market based approach, where the electricity provider calculates an emissions factor based on their purchase portfolio. This portfolio is the result of contractual arrangements such as renewable energy certificates, power purchase agreements and so on, and is quite easy to calculate as well as easy to apply. However, this approach has little basis in the physical reality of the emissions associated with electricity used at the specified location⁵. The non-physical basis of the outcome and its unsuitability for the investigation of time-dependent effects, the focus of this study, are the reasons we do not follow such an approach in this study.

The locational approach, in contrast to the market based approach, aims to apply averaging to known and measured quantities, such as generation mixes in the grid at the given location. An attempt is made to quantify emissions based on the physical reality of electricity production, transmission and distribution. In this study, we aim to make a physical estimation of emissions and therefore use a locational approach.

5.3.3 PRODUCTION AND CONSUMPTION BASED CARBON ALLOCATION

For locational (as well as for market-based) approaches, carbon emissions need to be allocated to producers or to consumers of electricity⁶. Production-based studies assign carbon emissions to the producers within the chosen geographical area, typically ignoring inter-regional trade. Calculation is extremely clear and transparent since power output from power plants, nature of fuel and other factors are well established.

Consumption based studies are more complicated since they need to account for trade across international interconnections and losses in the grid and are therefore typically reliant on the assumptions and calculation methodologies. Taking these additional factors into consideration, they give a more detailed estimate of the emissions associated with electricity consumption in interconnected grids with market trading [27].

In the absence of a clearly defined system boundary, double-counting of either emissions or emissions reduction can easily take place, being attributed to both producers as well as consumers [28]. This distinction is particularly important for cases where production as well as consumption take place, as in this study. In our case, we consider both production (scope 1) and consumption (scope 2) based emissions of the

⁵ Brander et al. [26] provide a detailed critique of market based approaches to carbon accounting.

⁶ or be allocated in some kind of shared manner.

solar carpark. Since we do not apply this method to other projects with which electricity is exchanged, we avoid the double counting of emissions.

5.3.4 GEOGRAPHICAL GRANULARITY AND CONSEQUENCES OF TRADING

In locational studies, the choice of the geographical system boundaries is critical to the grid mix considered when calculating an emission factor. Several studies use averages over very large (continent-spanning) geographical areas such as Europe [7, 29, 30] and the USA [31]. The average electricity mix of the continent can however, differ considerably from the local electricity mix. To overcome this discrepancy, for example, Nealer et al. [32] avoid USA-wide average approaches by dividing the country into 26 subregions based on the Emissions and Generation Resource Integrated Database (eGRID) provided by the US Environmental Protection Agency (EPA). These subregions were formed based on allocation of powerplants based on each plant's North American Electric Reliability Corporation (NERC) region, Balancing Authority, and transmission/distribution/utility service territory [33]. Their aim was to provide more granular data on the emissions associated with electricity use in different locations within the USA.

However, as noted by Tamayao et al. [34] and Colett et al. [35], different US-based studies use different criteria to divide the USA, such as the 8 NERC regions, the 50 political states, the 26 eGRID subregions or the 13 NERC subregions⁷. Colett et al. [35] pointed out that none of these boundaries really accounts for the complexity of dynamic and interconnected grids, and in particular, do not take trading across regions into account. Using a nested approach, they propose a new method for calculation of an emission factor, which is applied for cradle-to-gate analysis of primary aluminium production, a process very sensitive to the carbon intensity of grid electricity used. Variations of up to 11% difference in calculated values of $kg\ CO_2eq/kg\ Al$ were obtained for specific aluminium smelting plants when compared with those assuming the global average carbon intensity.

Similarly, Moro and Lonza [36] provide emission factors for electricity consumed in each of the 27 EU member states and the UK, taking cross-border trade as well as grid losses into account. These are then used to calculate the carbon intensity of electricity used at various voltage levels. Blume-Werry et al. [37] found that the hourly marginal or price-setting power plant in the Dutch Day Ahead Markets was located in another country for 75% of the hours in 2020. This shows that the inclusion of cross-border trade is particularly important for studies in highly interconnected countries in continental Europe such as the Netherlands, particularly when marginal emission factors are used.

⁷ studies also use the emissions factors from the Power Control Area (PCA), a market based approach, or the US average, which does not account for regional differences in energy mixes.

In this study, we use data representing the electricity consumed within the national boundaries of the Netherlands, a relatively small country. The effects of trade between the Netherlands and the surrounding countries is taken into account, as described in section 5.3.8.

5.3.5 TEMPORAL GRANULARITY AND INFLUENCE OF CHARGING PROFILES

After choosing a suitable granular geographical system boundary and incorporating the effects of trade, there is also a need to take into account the temporal variations in the electricity grid mix. The electricity grid mix is continuously changing and especially in grid where there is a share of production from variable renewable energy sources like solar and wind energy, there tend to be significant variations in carbon intensity in the grid with daily as well as seasonal patterns. Additionally, when considering loads such as EV charging which tend to have predictable daily profiles, the time of energy use can have a large role to play in the carbon intensity of electricity used.

For example, Denholm et al. [38] highlighted the role of mid-day charging of electric vehicles in increased utilization of otherwise curtailed mid-day peak production from solar photovoltaics in the ERCOT⁸ synchronous area in the USA. McLaren et al. [39] used hourly electric vehicle load demand based on actual driving behaviour to calculate the relative advantages of charging EVs at different locations across different grid mix scenarios. The charging location (which is associated with a defined temporal profile) is found to be a significant factor in the carbon emissions associated with EVs considered in the study.

Similarly, Ghotge et al. [40] investigated the annual average mean and hourly average carbon intensity of electricity used to charge EVs in the Netherlands. Significant variation in carbon intensity is found in individual charging sessions based on timeshifting of load within the session, again highlighting the importance of temporal granularity in the calculation of the emissions factor.

5.3.6 THE ATTRIBUTIONAL-CONSEQUENTIAL DISTINCTION

In Life Cycle Analyses (LCAs), there are two types of analyses: attributional and consequential. Attributional LCAs describe “the environmentally relevant physical flows to and from a life cycle and its subsystems” while consequential LCAs describe “how environmentally relevant flows will change in response to possible decisions” [41, 42]⁹.

⁸ The Electric Reliability Council of Texas (ERCOT) synchronous zone or the Texas interconnection is one of the five synchronous zones in North America, serving about 24 million customers in Texas.

⁹ Alternate definitions are provided by the European Commission - Joint Research Centre, Institute for Environment and Sustainability [43], describing the modelling framework. It defines attributional life cycle

Attributional analyses are typically used for attribution or allocation of responsibility. On the other hand, consequential studies are more focused on how these environmentally relevant flows will change i.e. the *systemic impact* as a result of changes with a view to guide decision-making. This distinction is now also considered in carbon accounting studies [44]. An example of a study requiring an attributional approach is the calculation of a carbon footprint of a product while a consequential approach is better to calculate the emissions reduction through the implementation of energy efficiency measures [45].

In carbon accounting studies, the shift from an attributional to a consequential approach influences the type of data which needs to be used in the study. For short term studies investigating timeshifting, changing load profiles and the effects of reduced load (as is the case in this study), consequential studies would use hourly marginal emissions whereas attributional studies would use hourly average emissions¹⁰. This is because an increase or decrease in power consumption at a given time step leads to ramping of only the marginal power plant/s while the power delivered to a given load at a given time step can equally (or in a weighted manner) be traced back to all the operational powerplants within the chosen geographical boundary at that time step.

Several studies with a consequential approach have therefore used marginal emissions [34, 45–47], while others use an attributional approach, considering hourly average emissions [36, 39, 40, 48]. Brander and Ascui [44] and Harmsen and Graus [45] both provide recommendations on when to use one or the other approach. Jochem et al. [49] and Baumgärtner et al. [50] use both approaches and discuss the differences between them, as is the case in this work as well.

The choice of approach also affects the quality of the results obtained. Information on the marginal power plant is typically obtained ex post through historic data of the merit order or ex ante through a merit order model [34, 49]. Graff Zivin et al. [51] used historic data from the US government to regress hourly CO_2 emissions against hourly electricity consumption for various defined regions. However, as pointed out by Tamayao et al. [34], when such an approach is applied in areas with variable renewables (like solar and wind) which change production independently of the load, marginal changes in emissions due to change in load can be erroneously attributed to non-marginal plants, causing systematic errors in the regression results.

On the other hand, the alternative approach which uses merit order models, can easily identify marginal power plants and the corresponding marginal emissions. However, factors like logistic constraints on power plant operation, transmission and distribution constraints, trading decision of market players and maintenance and availability related

inventory modelling as a “modelling frame that inventories the inputs and output flows of all processes of a system as they occur”. Consequential modelling, on the other hand, “identifies and models all processes in the background system of a system in consequence of decisions made in the foreground system”

¹⁰ We assume that a shorter temporal resolution than an hour is computationally intensive but leads to limited improvement in the accuracy of the results.

operational changes which are implicitly accounted for in the first approach, are not normally considered. These factors however, have very real effects on the merit order and consequently on the marginal emissions [52].

In this work, we overcome this need for modelling the merit order through the use of live data. Marginal powerplants at different time steps are identified in realtime, enabling the evidence-based calculation of marginal emissions. Details about the data used are provided in section 5.3.8.

5.3.7 ADOPTED METHODOLOGY

Based on the considerations described earlier, the methodology used in this work has the following characteristics:

1. A locational method is used, taking into account power flows at the site location
2. Both producer and consumer based emissions are included for a comprehensive overview of emissions associated with the project activity under consideration
3. The geographical granularity of the grid-based data is at the national level for the Netherlands, while including the influences of cross-border trading within the wider European synchronous area
4. Hourly time resolution of data is used to account for time-varying loads with daily patterns
5. We use both attributional and consequential approaches to calculate the annual carbon emissions and the annual offset carbon emissions, and discuss the differences.

The total carbon emissions, $C_{emissions}$ in $kg CO_2eq.$, are a sum of the emissions associated with operation over the project lifetime and the emissions associated with infrastructure for energy production and storage. When calculated over a period of one year, these are the annual carbon emissions.

$$C_{emissions} = C_{operational\ emissions} + C_{infrastructural\ emissions} \quad (5.1)$$

The operational emissions are associated with purchasing electricity from the grid, either to meet the load or charge the battery. This does not consider the effects of feed-in of electricity to the grid. The infrastructural emissions include the carbon emissions associated with the solar arrays, the balance of system and battery, as described in sections 5.3.8.2 and 5.3.8.3 respectively.

Expanding the terms,

$$C_{emissions} = \sum_{t=1}^T C I_t^{NL} \left(E_t^{G \rightarrow L} + E_t^{G \rightarrow B} \right) + C_{infrastructure}^{PV} + C_{infrastructure}^{Ni-MHBattery} \tag{5.2}$$

where t is the hour in the time interval, $1...T$, (for 1 year, the time interval is $1...8760$)

$C I_t^{NL}$ is the average carbon intensity of electricity consumed in the Dutch grid in the hour, t , in $kg CO_2eq./kWh$,

$E_t^{G \rightarrow L}$ is the electrical energy imported from the grid which is used to meet the load in the t^{th} hour in kWh ,

$E_t^{G \rightarrow B}$ is the electrical energy imported from the grid which is used to charge the battery in the t^{th} hour in kWh ,

$C_{infrastructure}^{PV}$ is the magnitude of GHG emissions associated with the PV array and balance of system in the project in $kg CO_2eq.$ (details in section 5.3.8.2),

$C_{infrastructure}^{Ni-MHBattery}$ is the magnitude of GHG emissions associated with the Ni-MH battery in the project in $kg CO_2eq.$ (details in section 5.3.8.3).

Carbon emissions are offset during the operation of the system through the substitution of grid electricity. The energy flows, such as generated solar energy used to meet the load or generated solar energy fed into the grid, result in substitution of grid electricity, and thus lead to offsetting of carbon emission. The magnitude of carbon offset in a given time step is proportional to the carbon intensity in the electricity grid at any given time step¹¹. On the other hand, additional energy sourced from the grid, such as that used to charge the battery, reduces this offset in the given time step.

The total offset carbon emissions, C_{offset} are calculated as the difference between the offset emissions in operation and the emissions embedded in infrastructure for energy production and storage. When calculated over a period of one year, these are the annual offset carbon emissions. The total offset carbon emissions in $kg CO_2eq.$, are calculated as:

$$C_{offset} = C_{operational offset} - C_{infrastructurel emissions} \tag{5.3}$$

$$= \sum_{t=1}^{8760} C I_t \left(E_t^{PV \rightarrow L} + E_t^{PV \rightarrow G} + E_t^{B \rightarrow L} + E_t^{B \rightarrow G} - E_t^{G \rightarrow B} \right) - C_{infrastructure}^{PV} - C_{infrastructure}^{Ni-MHBattery} \tag{5.4}$$

where t is the hour in the time interval, $1...T$, (for 1 year, the time interval is $1...8760$)

$C I_t$ is the hourly (average or hourly marginal) carbon intensity of electricity consumed in

¹¹ this may be the hourly carbon intensity or the marginal carbon intensity, depending on the method.

the Dutch grid in the t^{th} hour in $kg CO_2eq./kWh$,

$E_t^{PV \rightarrow L}$ is the electrical energy generated by the solar array which is directly used to meet the load in the t^{th} hour in kWh ,

$E_t^{PV \rightarrow G}$ is the electrical energy generated by the solar array which is fed into the grid in the t^{th} hour in kWh ,

$E_t^{B \rightarrow L}$ is the electrical energy discharged from the battery which is directly consumed by the load in the t^{th} hour in kWh ,

$E_t^{B \rightarrow G}$ is the electrical energy discharged from the battery which is fed into the grid in the t^{th} hour in kWh , and

$E_t^{G \rightarrow B}$ is the electrical energy imported from the grid which is used to charge the battery in the t^{th} hour in kWh ,

$C_{infrastructure}^{PV}$ is the magnitude of GHG emissions associated with the PV array and balance of system in the project in $kg CO_2eq.$ (details in section 5.3.8.2),

$C_{infrastructure}^{Ni-MHBattery}$ is the magnitude of GHG emissions associated with the Ni-MH battery in the project in $kg CO_2eq.$ (details in section 5.3.8.3).

The energy flows substituting grid electricity include $E_t^{PV \rightarrow L}$, $E_t^{PV \rightarrow G}$, $E_t^{B \rightarrow L}$ and $E_t^{B \rightarrow G}$. These lead to increased carbon offsets. On the other hand, $E_t^{G \rightarrow B}$ increases the use of grid electricity to charge the battery, thus decreasing carbon offset in any given time step.

We follow the thermodynamic sign convention [53]. As such, energy which enters the electrical energy system is taken as positive. This includes the electricity generated by the solar arrays, the discharging of the battery or electricity imported from the grid. On the other hand, energy leaving the electrical energy system is taken as negative: including dissipation in the load, charging of the battery or exported to the grid is taken as negative.

The energy flows between the PV array, the battery, the load and the grid, $E_t^{PV \rightarrow L}$, $E_t^{PV \rightarrow G}$, $E_t^{B \rightarrow L}$, $E_t^{B \rightarrow G}$ and $E_t^{G \rightarrow B}$, are known in the simulation. However, when this methodology is applied in practice, these values may also be calculated based on data from energy meters located at the solar inverter, the grid and the battery, as shown in Appendix 5.6. Details of the annual average method used for comparative purposes in the results are shown in Appendix 5.7.

5.3.8 GREENHOUSE GAS EMISSIONS DATA

This study makes use of data on the GHG emissions¹² of electricity sourced from the Dutch grid. It also uses data on the GHG emissions resulting from electricity produced

¹² In this study, we consider the greenhouse gases which are encompassed by the Global Warming Potential metric over a 100 year time horizon (GWP₁₀₀), as defined by the Intergovernmental Panel on Climate Change (IPCC) [54]. These provide up to date values based on corrections from the earlier IPCC reports.

and stored onsite, by the PV array and the battery respectively. These are each described below.

5.3.8.1 Carbon intensity of electricity sourced from the grid

We use two data sets, sourced from the company Tomorrow [55], describing the Carbon Intensity (CI) of electricity¹³ consumed in the Dutch grid. We use values for the year 2019, the last year where electricity use was unaffected by the COVID-19 pandemic and associated lockdowns. The first data set consists of the hourly average carbon intensity of electricity consumed in the Dutch grid and the second consists of the hourly marginal carbon intensity of electricity consumed within the Dutch grid.

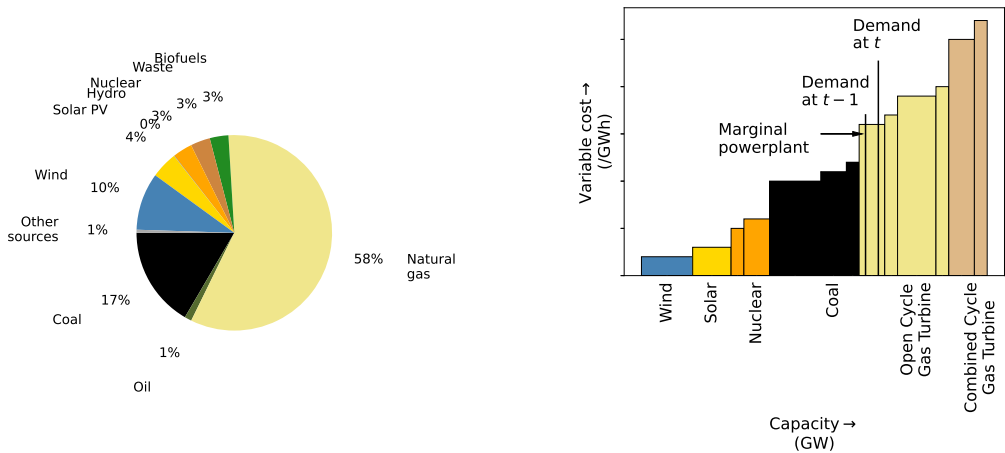

(a) Electricity generation by source in the Netherlands in 2019 [Total = 120 TWh] (Source: International Energy Agency [56])

(b) A merit order of powerplants for economic dispatch at a given timestep, showing the marginal powerplant (only for illustration)

Figure 5.7: Dutch electricity sector and merit order description

Fig. 5.7(a) shows the distribution of the 120 TWh of electricity generation in the Netherlands in 2019 [56]. Fossil fuels produced about 76% of electricity generated in the Netherlands in 2019, with high dependence on natural gas (58%). Variable renewables formed a small share of Dutch electricity generation, with 4% generated by

13 The carbon intensity of electricity is defined as the net GHG emissions by weight in $CO_2-eq.$ emitted per unit of electricity. It may be expressed based on production or consumption of electricity. Carbon intensity is also referred to in literature as greenhouse gas emissions intensity, carbon emission intensity and carbon dioxide intensity.

solar photovoltaics and 10% by wind. The Netherlands was a net exporter in 2019 with 0.3 TWh of annual net export [57].

Fig. 5.7(b) shows an illustrative example of a dispatch curve formed by arranging the available powerplants in a given hour in order of increasing variable cost of generation. The merit order thus obtained typically places variable renewables with low marginal cost (wind and solar) and must-run powerplants (like nuclear) at the very left. The demand, assumed to be price-inelastic and therefore vertical, meets the dispatch curve at the marginal powerplant.

The hourly average carbon intensity of electricity consumed in the Dutch grid, CI_t^{NL} is calculated as the energy-weighted average carbon intensity of all the powerplants that meet demand in the hour, t . For the example shown in Fig. 5.7(b), the hourly average carbon intensity would represent the proportional fractions of wind, solar, nuclear, coal and open cycle gas powerplants.

The hourly marginal carbon intensity of electricity consumed in the Dutch grid, $CI_t^{NL-marginal}$, is the carbon intensity of the powerplant or the energy-weighted average carbon intensity of the combination of powerplants that ramp up or ramp down in response to change in demand in the hour, t . For the example shown in Fig. 5.7(b), the hourly marginal carbon intensity value would represent the carbon intensity of only the open cycle gas turbine power plant which ramped up to meet the increase in demand with respect to the previous time step, $t - 1$.

The carbon intensity values in the two data sets are based on computationally tracing the flow of electricity back from the point of load to the points of production. They incorporate both realtime generation from the powerplant mix as well as realtime cross-border trade [55, 58]. A machine learning approach is used to identify the marginal powerplant, based on which the resulting marginal carbon intensity is estimated¹⁴.

¹⁴ Further details on the method used to identify the marginal powerplant are provided in [59]

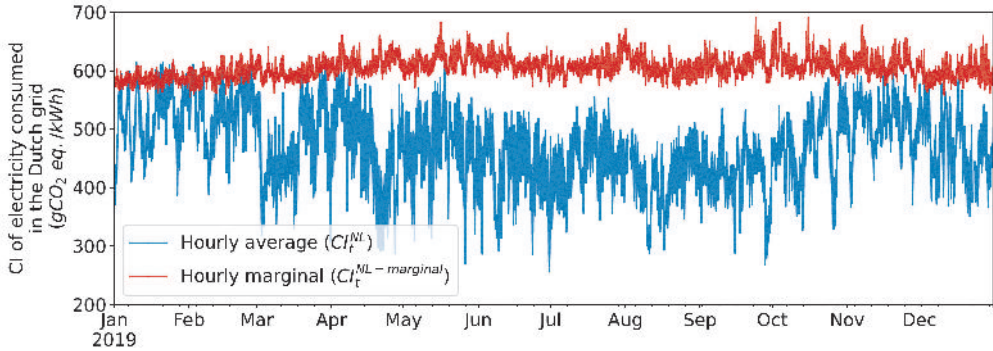

(a) Carbon intensities over 2019

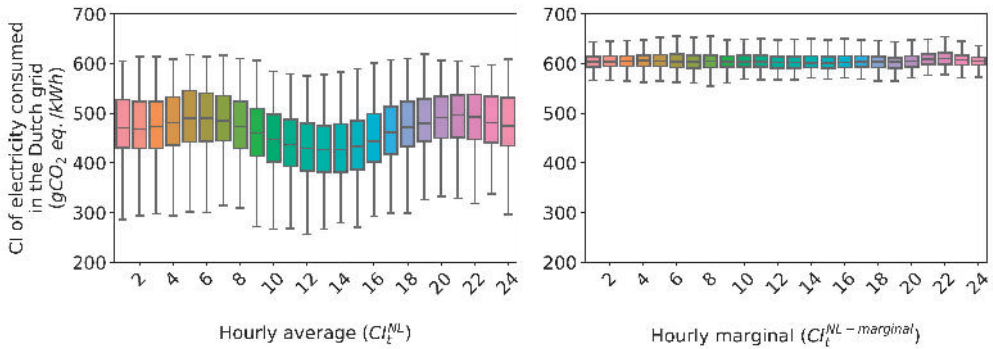

(b) Carbon intensities over the year grouped by time of day

Figure 5.8: Hourly average and hourly marginal carbon intensity of electricity consumed in the Dutch low voltage grid in 2019

Note: For the boxplots, the horizontal lines within each box show the median value. The top and bottom of the box represent the 25th and 75th percentile values. The whiskers show the outermost datum within 1.5 times the interquartile range, beyond which values are considered outliers, and are not shown.

The carbon intensity of grid electricity accounts for emissions over the entire lifecycle of the powerplant, covering construction, fuel production, operational emissions and final decommissioning [55, 60]. The values used are shown in Fig. 5.8.

Fig. 5.8(a) shows that there is a clear seasonal effect in the hourly average CI over the year, with lower values during the summer (June through September) as compared with the winter. On the other hand, there is no clearly distinguishable effect in the hourly marginal values. Fig. 5.8(b) shows the CI values over the year grouped by the time of day. It shows that there is also a daily pattern in the hourly average CI data, with the mean values as

well as the ranges showing two distinct peaks, each in the morning and the evening. The hourly marginal CI shows no clear daily trend.

5.3.8.2 Greenhouses gas emissions associated with the PV array

The results of LCAs of solar photovoltaics are often reported per functional unit¹⁵, kWh , so as to be comparable with other forms of energy based on a $g\ CO_2\text{-eq.}/kWh$ metric. However, these calculations depend upon the irradiance profile at the assumed location of installation, the assumed project lifetime and the assumed efficiency, each of which affects the energy generated over the PV lifecycle. To compensate for the variability of inputs in different studies, they need to be subjected to harmonisation techniques as described in [61]. The weightage of PV emissions by kWh also gives the misleading impression that these emissions occur over the operational phase, when in fact they occur almost entirely during the manufacturing and transport phases [60].

We therefore use updated GWP values of monocrystalline silicon modules with installed capacity in kWp as the function unit, as reported by Fthenakis and Leccisi [62]. These include the PV modules as well as the Balance-of-System (BoS)¹⁶. The study is based on Life Cycle Inventory (LCI) data from the Ecoinvent v3 data base and the most recent IEA PVPS Task 12 report [63] and was conducted using SimaPro 9. They include the assumption of Chinese manufacturing, since Chinese modules dominate the global market. For the monocrystalline Si modules in this study, the values considered are shown in Table 5.7¹⁷.

Table 5.7: Carbon emissions from the PV array (Source: Fthenakis and Leccisi [62])

Indicator	Value
GWP value per kWp	1010 $kg\ CO_2\text{-eq.}/kWp$
GWP value per 440Wp module	444 $kg\ CO_2\text{-eq.}/module$
Total GWP for 464.64 kWp installed capacity	469,000 $kg\ CO_2\text{-eq.}$

15 The Functional Unit (FU) in an LCA is defined as the “quantified performance of a product system for use as a reference unit” by ISO 14040:2006. They are typically chosen to be units which fulfill all the functions of the product considered, can be substituted by alternative products and serve as a basis for comparison of various alternatives.

16 The BoS includes the mounting and support structures, cables and power electronics.

17 In terms of materials, bifacial modules involve about 3 kg less aluminium, about 10 kg more solar glass and about 10 kg more chemicals (including HF , HNO_3 , HCl , H_2SO_4 , KOH , H_2O_2 , O_2 , NH_3 , $POCl_3$, N_2) on a per kWp basis [64]. The GWP of the PV array is more sensitive to the weight of aluminium than to that of the other materials, due to the high GWP ($>8\ kg\ CO_2\text{-eq.}/kg$) associated with aluminium production. Due to this, bifacial modules have a slightly lower GWP than monofacial modules per kWp. We retain the use of the GWP value for monofacial modules as an upper limit.

A comparison of the values used in this study with other values found in literature is provided in Appendix 5.8.

5.3.8.3 *Greenhouse gas emissions associated with the nickel-metal hydride battery*

For the battery system, we consider the functional unit as *1 kg of nickel-metal hydride battery*. The weight-based functional unit was chosen since it is widely reported in literature and therefore comparable (see Appendix 5.9). Additionally, we also report values per *kWh* of storage capacity.

A large fraction of the GWP of nickel-metal hydride batteries is due to GHGs emitted over the manufacturing and assembly phases. The manufacture of electrode pastes and substrates for the cathode and anode are associated with the largest fractions of GWP, with lower fractions for the separators, cell containers and battery packs.

For the batteries, we use GWP values reported in Silvestri et al. [65]. The LCA was conducted according to ISO 14040/44, 2006 and carried out using SimaPro 9. The lifecycle inventory was based on a combination of Ecoinvent v3 and previous literature, with the assumption of electricity consumption based on the German electricity mix¹⁸. Transportation of the raw materials and batteries and end-recycling was also included within the scope. These values are provided in Table 5.8.

Table 5.8: Carbon emissions from the nickel-metal hydride battery pack (Source: Silvestri et al. [65])

Indicator	Value
GWP value per kg of battery system	27.3 kg CO ₂ -eq./kg battery
GWP value per kWh of rated energy storage capacity	763 kg CO ₂ -eq./kWh
Total GWP for 9660 kg Ni-MH battery	264,000 kg CO ₂ -eq.
Total GWP for 345.6 kWh installed energy storage capacity	

A comparison of the values used in this study with other values in literature is presented in Appendix 5.9.

¹⁸ The actual Nilar batteries were produced in Sweden.

5.4 RESULTS AND DISCUSSIONS

We describe the operation of the solar carpark for EV charging over the simulated year, 2019. The resulting values obtained for annual carbon emissions and annual offset carbon emissions are presented. We further investigate the contribution of the nickel metal hydride battery to the annual offset carbon emissions.

5.4.1 OPERATION OF THE SOLAR CARPARK FOR EV CHARGING

The operation of the solar carpark for EV charging can be described through the SoC of the Ni-MH battery and the exchange of power between the system and the grid over the simulated year. These are shown in Fig. 5.9(a) and 5.9(b) respectively.

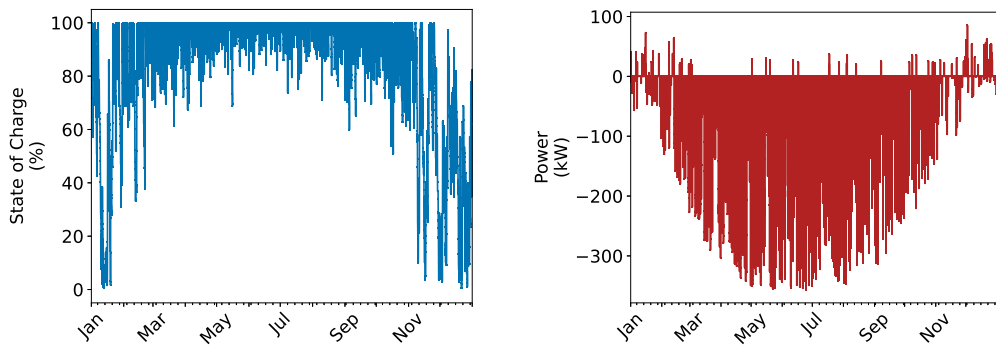

(a) Ni-MH battery State of Charge (SoC) over the simulated year (b) Power exchanged with the grid over the simulated year

Figure 5.9: Operation of the solar carpark for EV charging over the simulated year

Similar to the operation of several systems analysed in literature [22, 23, 66], the battery SoC remains high during the summer, as seen in Fig. 5.9(a). Between March and September, the battery generally cycles between 100% and 80% SoC. A large fraction of the generated power during these months is exported to the grid, shown as negative in Fig. 5.9(b). Over this period, the solar array and the battery are able to meet EV demand with minimal grid purchase (shown in positive in Fig. 5.9(b)).

Fig. 5.9(a) shows that during the remaining months: January to February and October to December, the battery SoC is lower. During these months, electricity is purchased from the grid more often since the PV production is insufficient to charge the batteries to a high SoC.

Some important indicators describing the operation of the system are provided in Table 5.9. A large fraction of the produced solar energy is exported to the grid over the year, particularly in comparison with the annual purchased energy. The large export-to-import ratio is the reason why such a project can offset emissions.

Table 5.9: Energy exchanged by the solar carpark and battery with the grid over the simulated year

Indicator	Value
Annual imported electricity	2.7 MWh
Annual fed-in electricity	340 MWh
Annual battery throughput ¹	27 MWh

¹ Battery throughput is the total energy stored (charged and subsequently discharged) in the battery over several cycles.

5.4.2 ANNUAL CARBON EMISSIONS AND ANNUAL OFFSET CARBON EMISSIONS

The annual carbon emissions and the annual offset carbon emissions, as calculated by the various methods are presented in Table 5.10. The emissions associated with the solar PV system and the Ni-MH battery system are also shown.

Table 5.10: Annual carbon emissions and annual offset carbon emissions of the solar carpark for EV charging in 2019

Indicator	Value	Unit	Method
<i>Operational emissions</i>			
Annual	1,260	$kg\ CO_2eq./year$	Annual average CI
	1,300		Hourly average CI
Annual offset	157,100	$kg\ CO_2eq./year$	Annual average CI
	167,800		Hourly average CI
	243,000		Hourly marginal CI
<i>Infrastructural emissions</i>			
Solar PV	469,000	$kg\ CO_2eq.$	LCA in literature
Ni-MH Battery	264,000	$kg\ CO_2eq.$	LCA in literature

The results show that there is a small difference (3%) between the annual carbon emissions in operation as calculated based on the hourly average CI and the annual average CI. Emissions from the solar carport occur in operation when the system uses electricity from the grid. This occurs primarily during the winter months when the CI is higher than the annual average of $468\ g\ CO_2eq./year$ (see Fig. 5.8(a)). As such, the use of hour-specific CI values are expected to lead to higher calculated values.

Fig. 5.10 shows the net carbon emissions offset by the solar carport for EV charging after a year of operation. The emissions associated with infrastructure, shown on the left, exceed the annual offset carbon emissions in operation, which are shown on the right.

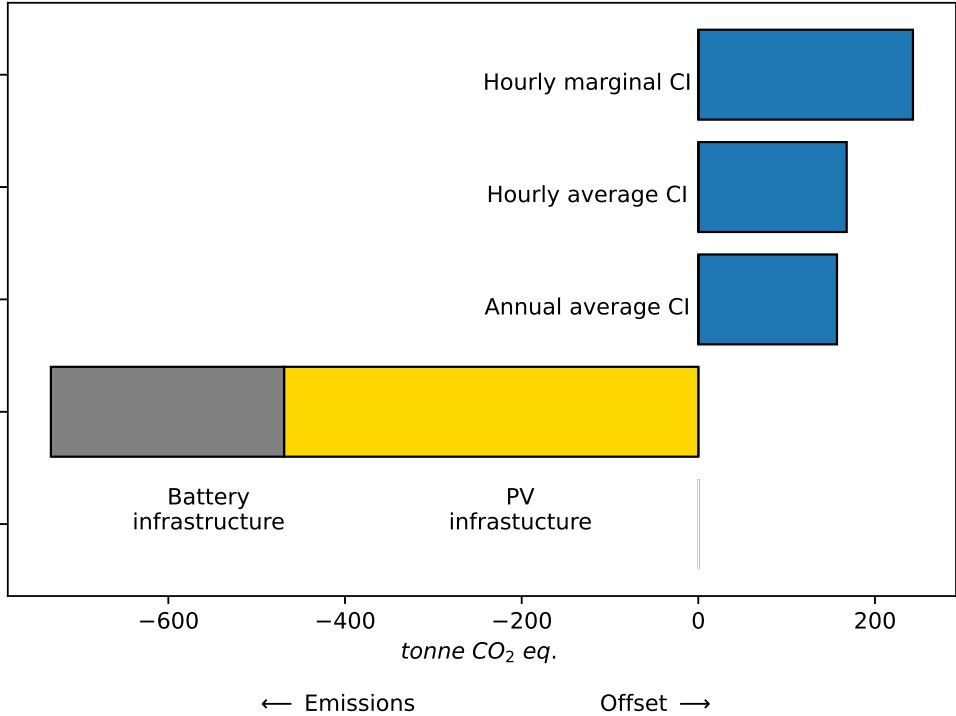

Figure 5.10: Net carbon emissions and offset by the solar carport for EV charging after one year of operation

Regardless of the method of calculation, the solar carpark leads to carbon offset over its expected lifetime, exceeding 10 years. The calculated values of annual offset carbon emissions in operation over the simulated year, 2019, depends on the method of calculation, as shown in Fig. 5.10.

The annual offset carbon emissions in operation calculated based on hourly average CIs gives a higher value than when based on the annual average, by 6.8%. The offset of emissions are mainly caused by the feed-in of solar power to the grid. However, feed-in occurs at times when the fraction of solar energy in the grid is the highest. High solar fraction leads to a lower CI of electricity during midday and particularly in the summer months, seen in Fig. 5.8. As such, the use of hour-specific CI would be expected to lead to a lower offset emissions over the year, which was found not to be the case. On closer analysis, we found this to be due to the timeshifting of demand enabled by battery cycling.

Fig. 5.11 shows the power exchanged by the battery over the simulated year, grouped by hour of the day. Retaining the earlier sign convention, negative values represent battery charging while positive values represent charging.

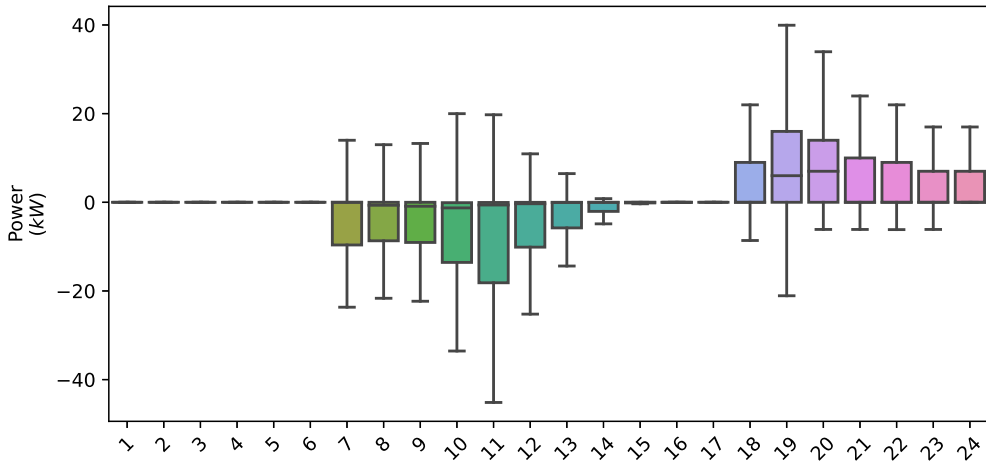

Figure 5.11: Battery power exchanged over the year grouped by hour of the day

Note: The horizontal lines within each box show the median value. The top and bottom of the box represent the 25th and 75th percentile values. The whiskers show the outermost datum within 1.5 times the interquartile range, beyond which values are considered outliers, and are not shown.

Fig. 5.11 shows that throughout the year, the battery charges in the morning and noon, and discharges to loads in the late evening, when the hourly CI is generally higher. This intra-day shift of high CI power demand in the evenings by solar electricity stored and discharged battery leads to the calculation of larger carbon offset overall. It is this behaviour that we aim to analyse and quantify, for which the use of annual average method cannot be used.

We now consider the consequential approach, as opposed to the attributional approaches used earlier. In this case, rather than capturing the share of emissions offset by the solar carport, we quantify the *additional carbon offset* as a result of adding the solar carport to charging of EVs from the grid in the same location, which is the reference scenario it is compared with. When viewed from this perspective, the calculation requires the use of the hourly marginal CI: the emissions associated with the incremental use of electricity. The use of hourly marginal emissions yields a value of annual offset carbon emissions that is higher by 55% and 45% relative to annual average and hourly average values respectively. The consequential approach to carbon offset

calculation therefore results in a larger estimate of annual offset carbon emissions by the solar carpark for EV charging.

Recent policy changes at the Dutch national level have led to carbon offsetting being a prominent metric of project evaluation [67]. The current practice is to use time-invariant emission factors¹⁹. The extent of the differences between offset carbon in the three calculation methods is particularly notable in light of this policy shift. We aim to further analyse the contribution of intra-day battery cycling to carbon offset, which cannot be estimated through annual average methods.

5.4.3 EMISSIONS OFFSETTING ENABLED THROUGH BATTERY CYCLING

In order to estimate the contribution of the Ni-MH battery to the annual emissions offset by the solar carpark, we compare the emissions of a solar carpark with and without a battery. The case with the battery is described in section 5.4.2. For the solar carport without the battery, we assume the utility grid to absorb all excess power produced by the solar array beyond the EV demand as well as to deliver all deficit EV demand that the solar array is unable to meet.

The exchanges between the carpark system with the grid in each case are shown in Table 5.11. The carpark system without a battery, holding all other parameters constant, exchanges more energy with the grid, both as imported electricity and as feed-in. This is primarily because the charging of the battery reduces the magnitude of solar feed-in while the discharging of the battery reduces the amount of electricity purchased by the grid.

Table 5.11: Energy exchanged by the solar carpark and battery with the grid over the simulated year

Indicator	Solar carpark	
	with battery	without battery
Annual imported electricity	2.7 MWh	29.3 MWh
Annual fed-in electricity	338.3 MWh	364.8 MWh

The differences in energy exchanged with the grid affect the annual emissions offset by the project. Based on the different methods of calculation, the annual offset emissions are provided in Table 5.12.

¹⁹ As an example, the SDE++ subsidy mechanism uses 216 g CO₂eq. for solar photovoltaic projects [68].

Table 5.12: Annual offset carbon emissions over the simulated year, 2019, by the solar carpark with and without the NI-MH battery

Method	Annual offset carbon emissions		Unit
	with battery	without battery	
Annual average CI	157,100	157,000	<i>kg CO₂eq. /year</i>
Hourly average CI	167,800	167,100	
Hourly marginal CI	243,000	242,900	

The results in Table 5.12 show that across the different methods of calculation, the contribution of the battery to the annual offset carbon emissions by the solar carpark system is negligible. Unlike the annual average CI approach, both the hourly average and hourly marginal approaches account for changes in the demand and feed-in profiles of the solar carpark. However, using these methods still show a negligible difference in the calculated annual offset carbon emissions between a solar carpark with and without the Ni-MH battery.

The difference between emissions offset in each hour by the solar carpark system with a battery (+ve) and the system without a battery (-ve) are shown in Fig. 5.12. We use the hourly marginal CIs since we aim to analyse the incremental contribution of the battery, thus a consequential analysis. Fig. 5.12(a) shows the differences in offset emissions each hour grouped by hour in the day, while Fig. 5.12(b) shows these values grouped by day in the year. The positive values indicate that the hourly carbon offset by the solar carpark with the battery exceeds the hourly carbon offset by the solar carpark without the battery, and the negative values indicate the inverse case.

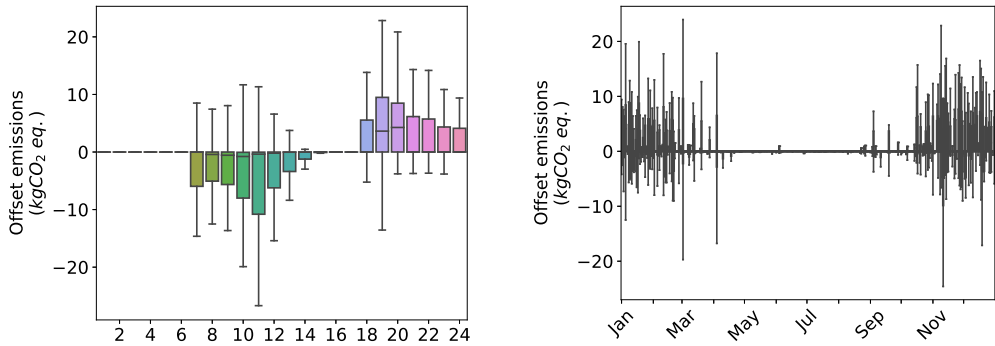

(a) Difference in hourly carbon offset grouped by hour (b) Difference in hourly carbon offset grouped by day in the year

Figure 5.12: Differences in hourly carbon offset over the year for the system with batteries and the system without batteries, based on marginal CIs

Note: The horizontal lines within each box show the median value. The top and bottom of the box represent the 25th and 75th percentile values. The whiskers show the outermost datum within 1.5 times the interquartile range, beyond which values are considered outliers, and are not shown.

Fig. 5.12(a) shows that the system with a battery mainly offsets emissions in the evening whereas the system without a battery mainly offsets emissions during the afternoon. The grouping of power values by day of the year in Fig. 5.12(b) shows that the largest differences in emission offset between the two cases all occur in the winter, when most battery cycling takes place. However, the emissions offset through daily timeshifting of energy do not lead to noticeable additional offsetting of emissions overall.

Increasing the scale of storage is not likely to make a difference. As seen in Fig. 5.9(a), the battery tends to be close to full in the summer and drops to low SoCs in the low irradiance winter months, with infrequent full cycles. Larger storage capacity will therefore not increase battery utilisation, and correspondingly not lead to an increased contribution to annual offset carbon emissions.

5.4.4 LIMITATIONS OF THIS WORK

The results obtained in this work have limitations which should be discussed. These are related to the representativeness of the system analysed and the applicability of the applied methodology.

The operation of the system and the results obtained from the emission offsetting calculations are dependent on the specific battery dispatch algorithm used here. Since

the formulation of the algorithm was not the main objective of this work, a relatively simple algorithm was used. A case could be made that alternative algorithms with further interaction with the grid could lead to different offset emissions, for which our results are not representative. However, any alternative battery dispatch algorithm would function with electricity production and consumption patterns similar to the ones used here. The high summer-winter difference in solar energy production is a function of the system location, and conditions are similar across northwestern Europe. The workplace charging patterns are based on empirical data that is linked with daily routines of EV drivers, which are unlikely to change. Operating within these parameters, we argue that alternative battery dispatch algorithms will not greatly increase the annual offset carbon emissions, and therefore our results are representative across other battery systems with different dispatch algorithms. Since these parameters also hold true across other countries of northern Europe, we also expect the contribution of batteries to offsetting carbon emissions in these geographies to be correspondingly low.

The second limitation is the applicability of the proposed methods. The method we use to calculate the annual carbon emissions and annual offset carbon emissions in practice require detailed monitoring, energy flow calculations at the hourly level and detailed time series data about the carbon emissions from the electricity grid at the point of demand. While this method provides highly location and project specific detailed insights, we expect the data requirements to be too high for it to be applied widely. The reliance on empirical data makes this method insensitive to assumptions and errors in modelling, which is the alternative. However, it is still sensitive to the completeness and availability of data on carbon intensity, calculated based on realtime inputs from the power plants within the geographical vicinity of the studied project.

5.4.5 OUTLOOK ON THE FUTURE

With greater deployment of variable renewable energy sources in the Dutch electricity grid, there will be a corresponding reduction in the annual average carbon intensity of electricity in the Dutch grid. With lower emissions overall in a cleaner grid, we expect the contribution of batteries to carbon offset to further reduce.

Recent studies show that fossil fuels like gas (27%), coal (18%) and lignite (11%) power plants tend to be the marginal power plant for Dutch electricity consumption for about 64% of the year [37], explaining the higher CI of marginal power plants than hourly average. It is only at times when the electricity prices are very low (the bottom tercile) that nuclear, renewables and pumped hydro provide marginal power, though still in a similar share as gas and lignite. With a rising share of renewables, coal and lignite are likely to be displaced first, with gas remaining within the mix for its lower emissions compared with the others as well as for the ramping capabilities of gas powerplants.

In the future, we expect the patterns in marginal CI to more closely resemble the current hourly average CI, with more distinct daily and seasonal trends following renewable production, with gas providing marginal power for an even larger fraction of the year. Offsetting carbon in the high-RE grid described here will likely be less of a priority than limiting curtailment, meeting energy deficit at short timescales and providing frequency reserves that batteries are technologically suited to provide.

5.5 CONCLUSIONS

In this study, we investigate a solar carpark for EV charging with a Ni-MH battery with a view to quantifying the magnitude of offset carbon emissions per year and the extent of contribution of the battery storage. We find the prevalent practice of applying annual average carbon intensity unsuitable for estimating this value since this approach does not account for the intra-day variations in solar production, EV demand and battery cycling. We therefore propose a novel method to calculate the annual offset carbon emissions of the solar carpark, making use of the hourly average and hourly marginal carbon intensity.

The solar carpark for EV charging leads to carbon offset over its expected lifetime, exceeding 10 years, across all methods of calculation. However, we find that the choice of approach makes a difference to the values calculated for the annual offset emissions of the solar carpark. The use of hourly average carbon intensity yields a higher calculated value of annual offset carbon emissions in operation by about 7% relative to a method using the annual average carbon intensity. This suggests that these intra-day variations play a role in offsetting of carbon emissions.

The differences in the results obtained by different methods are seen in Table 5.13. It shows the values calculated for the annual offset carbon emissions over the operation of the solar carpark calculated using the annual average, the hourly average and the hourly marginal carbon intensities.

Table 5.13: Annual offset carbon emissions during operation of the solar carpark for EV charging in 2019

Method	Annual offset carbon emissions in operation (<i>kg CO₂eq./year</i>)
Annual average CI	157,100
Hourly average CI	167,800
Hourly marginal CI	243,000

We find that the calculated value of the annual offset carbon emissions in operation are higher by 55% when the hourly marginal carbon intensity is used relative to the value calculated with the annual average carbon intensity. This suggests that new solar carparks have about a 55% higher incremental effect on the carbon intensity associated with the new load of EV charging than the values conventionally calculated.

When comparing the annual offset carbon emissions by the solar carpark with and without a battery, we find that the use of the battery has a negligible effect on the annual carbon offset by the system. This result is found to be robust across all the methods of calculation. We therefore conclude that the use of batteries in solar carparks have a low contribution to the total carbon offset by the solar carport. With further increase in the share of variable renewable energies in the grid, we expect this low contribution to further decrease.

The limitations of the work are that the study analyses a very specific system within its scope. However, we argue that our results are more widely valid across battery storage systems in northern Europe. The large requirements of data from monitoring of the carport and from the grid make the universal application of our method challenging.

For future work, our method can be applied to the operational solar carpark in Dronten, to validate the results obtained here. The method can also be generalised for application to systems, which include production, consumption of energy as well as demand response. These can include industrial heating and cooling systems, power-to-gas and aggregated EV fleets, all of which have the possibility to offset carbon through the timeshifting of demand.

5.6 APPENDIX A: DERIVATION OF HOURLY ENERGY FLOWS

The energy flows between each of the components, $E_n^{PV \rightarrow L}$, $E_n^{PV \rightarrow G}$, $E_n^{B \rightarrow L}$, $E_n^{B \rightarrow G}$ and $E_n^{G \rightarrow B}$ can be derived based on the power metered at a solar carpark for EV charging. The details are given below, with the assumption of measurements at one-minutely frequency at the solar array, P^{PV} , at the grid connection point, P^G , and at the battery point of common coupling, P^B . The formulae used for each of these calculations are given below:

$E_n^{PV \rightarrow L}$:

For a single hour, the energy from the solar array to the load, $E_n^{PV \rightarrow L}$, in kWh , was calculated as

$$E_t^{PV \rightarrow L} = \Delta n \sum_{n=1}^{60} P_n^{PV \rightarrow L} \tag{5.5}$$

where Δn is the number of minutes in an hour (60).

For each minute, the power flowing from the solar array to the load, $P_n^{PV \rightarrow L}$, in kW , was calculated as

$$P_n^{PV \rightarrow L} = \min(P_n^{PV}, P_n^L) \text{ for every minute } n \text{ in the } t^{th} \text{ hour} \tag{5.6}$$

$E_n^{PV \rightarrow G}$:

For a single hour, the energy from the solar array to the grid, $E_n^{PV \rightarrow G}$, in kWh , was calculated as

$$E_t^{PV \rightarrow G} = \Delta n \sum_{n=1}^{60} P_n^{PV \rightarrow G} \tag{5.7}$$

where Δn is the number of minutes in an hour (60).

For each minute, the power flowing from the solar array to the grid, $P_n^{PV \rightarrow G}$, in kW was calculated as

$$P_n^{PV \rightarrow G} = \begin{cases} P_n^G, & P_n^{PV} \geq |P_n^L| \wedge P_n^B \leq 0 \wedge (P_n^{PV} - |P_n^L|) > |P_n^B| \\ 0, & P_n^{PV} \geq |P_n^L| \wedge P_n^B \leq 0 \wedge (P_n^{PV} - |P_n^L|) \leq |P_n^B| \\ P_n^G + P_n^L, & P_n^{PV} \geq |P_n^L| \wedge P_n^B \geq 0 \\ 0, & P_n^{PV} < |P_n^L| \end{cases} \tag{5.8}$$

$E_n^{B \rightarrow L}$:

For a single hour, the energy from the battery to the load, $E_n^{B \rightarrow L}$, in kWh , was calculated as

$$E_t^{B \rightarrow L} = \Delta n \sum_{n=1}^{60} P_n^{B \rightarrow L} \quad (5.9)$$

where Δn is the number of minutes in an hour (60).

For each minute, the power flowing from the battery to the load, $P_n^{B \rightarrow L}$, in kW was calculated as

$$P_n^{B \rightarrow L} = \begin{cases} \min(|P_n^L| - P_n^{PV \rightarrow L}, P_n^B), & P_n^B \geq 0 \wedge |P_n^L| > P_n^{PV \rightarrow L} \\ 0, & P_n^B < 0 \\ 0, & |P_n^L| \leq P_n^{PV \rightarrow L} \end{cases} \quad (5.10)$$

$E_n^{B \rightarrow G}$:

For a single hour, the energy from the battery to the grid, $E_n^{B \rightarrow G}$, in kWh , was calculated as

$$E_t^{B \rightarrow G} = \Delta n \sum_{n=1}^{60} P_n^{B \rightarrow G} \quad (5.11)$$

where Δn is the number of minutes in an hour (60).

For each minute, the power flowing from the battery to the grid, $P_n^{B \rightarrow G}$, in kW was calculated as

$$P_n^{B \rightarrow G} = \begin{cases} P_n^B - P_n^{B \rightarrow L}, & P_n^G < 0 \wedge P_n^B > 0 \wedge P_n^B > P_n^{B \rightarrow L} \\ 0, & P_n^B \leq 0 \\ 0, & P_n^G \geq 0 \\ 0, & P_n^B \leq P_n^{B \rightarrow L} \end{cases} \quad (5.12)$$

$E_n^{G \rightarrow B}$:

For a single hour, the energy from the grid to the battery, $E_n^{G \rightarrow B}$, in kWh , was calculated as

$$E_t^{G \rightarrow B} = \Delta n \sum_{n=1}^{60} P_n^{G \rightarrow B} \quad (5.13)$$

where Δn is the number of minutes in an hour (60).

For each minute, the power flowing from the grid to the battery, $P_n^{G \rightarrow B}$, in kW was calculated as

$$P_n^{G \rightarrow B} = \begin{cases} |P_n^B| - P_n^{PV \rightarrow B}, & P_n^B < 0 \wedge P_n^G > 0 \wedge |P_n^B| > P_n^{PV \rightarrow B} \\ 0, & P_n^B \geq 0 \\ 0, & P_n^G \leq 0 \\ 0, & |P_n^B| \leq P_n^{PV \rightarrow B} \end{cases} \quad (5.14)$$

5.7 APPENDIX B: ANNUAL AVERAGE APPROACH

We calculate the annual carbon emissions, $C_{emissions}$, using the annual average approach as

$$C_{emissions} = C I_{annual\ average}^{NL} \times \sum_{t=1}^{8760} E_t^{demand} \quad (5.15)$$

where t is the hour in the year,

$C I_{annual\ average}^{NL}$ is the annual average carbon intensity and

$\sum_{t=1}^{8760} E_t^{demand}$ is the annual electricity demand from the solar carpark for EV charging.

For the Dutch grid, the annual average carbon intensity, $C I_{annual\ average}^{NL}$, was obtained as the ratio of the total emissions to the total electricity demand in the Netherlands in 2019.

$$C I_{annual\ average}^{NL} = \frac{\sum_{t=1}^{8760} C I_t^{NL} \times E_t^{NL}}{E^{NL}} \quad (5.16)$$

where t is the hour in the year,

$C I_t^{NL}$ is the hourly average carbon intensity of electricity consumed in the Dutch grid in $g\ CO_2eq./kWh$, described in section 5.3.8,

E_t^{NL} is the electricity demand in the Netherlands in the t^{th} hour in TWh and

E^{NL} is the total electricity demand in the Netherlands in 2019 in TWh.

The value obtained for $C I_{annual\ average}^{NL}$ is $468\ g\ CO_2eq./kWh$.

5.8 APPENDIX C: LITERATURE ON GWP OF SOLAR PHOTOVOLTAICS

Table 5.14 provides an overview of the historic development of GWP values associated with solar photovoltaics. The significant reduction in recent years is attributed to reduction in silicon wafer thickness and kerf losses. Further reductions may be expected, particularly with the increased use of low carbon energy during the manufacturing process. Further discussion may be found in [62, 69].

Table 5.14: Literature review on GWP of solar PV systems per kWp installed capacity

GWP ₁₀₀ value <i>(kg CO₂-eq./kWp)</i>	Source	Publication Year	Comments
1010*	Fthenakis and Leccisi [62]	2021	Based on 20.5% efficiency monocrystalline silicon modules and Chinese manufacture
723	Luo et al. [70]	2018	Based on 16.2% PERC glass-glass modules and Singaporean manufacture. Value were reported in <i>kg CO₂-eq./60 cell module</i> and were converted to <i>kg CO₂-eq./kWp</i> base on <i>280 Wp/module</i> for modules with similar efficiency.

Continued on the next page

Table 5.14 – continued from the previous page

GWP ₁₀₀ value	Source	Publication Year	Comments
<i>(kg CO₂-eq./kWp)</i>			
2000	Leccisi et al. [71]	2016	Based on 17% efficiency monocrystalline silicon modules and Chinese manufacture.
2728	Wild-Scholten et al. [72]	2014	Based on monocrystalline silicon modules manufactured across the world, weighted by production capacity.

* The value used in this study

5.9 APPENDIX D: LITERATURE ON GWP OF NI-MH BATTERIES

Table 5.15: Literature review on GWP of nickel-metal hydride batteries per kg of battery pack

GWP ₁₀₀ value <i>(kg CO₂-eq./kg)</i>	Source	Publication Year	Comments
27.3*	Silvestri et al. [65]	2020	Based on ISO 14040/44 standardised LCA, includes end-of-life treatment and recycling (Scenario 2) and assumes German manufacture
18.2	Wang et al. [73]	2021	Includes reuse and recycling (Scenario C) and assumes Japanese manufacture
20	Mahmud et al. [74]	2019	Based on ISO 14040/44 standardised LCA, does not include end-of-life treatment and recycling (Scenario 2) and assumes Japanese manufacture
20	Majeau-Bettez et al. [75]	2011	Does not include end-of-life phase and assumes average European conditions for manufacture.

* The value used in this study

REFERENCES

- [1] The European Parliament and the Council of the European Union, *Regulation (EU) 2019/ 631 of the European Parliament and of the Council of 17 April 2019 - setting CO2 emission performance standards for new passenger cars and for new light commercial vehicles, and repealing Regulations (EC) No 443 / 2009 and (EU) No 510 / 2011*. 2019. URL: <https://eur-lex.europa.eu/legal-content/EN/TXT/PDF/?uri=CELEX:32019R0631&from=EN>.
- [2] The European Parliament and the Council of the European Union, *Regulation (EU) 2019/631 of the European Parliament and of the Council of 17 April 2019 setting CO2 emission performance standards for new passenger cars and for new light commercial vehicles, and repealing Regulations (EC) No 443/2009 and (EU) No 510/2011*. 2021. URL: <https://eur-lex.europa.eu/legal-content/EN/TXT/PDF/?uri=CELEX:02019R0631-20210301&from=EN>.
- [3] The European Parliament and the Council of the European Union, *Proposal for a Regulation of the European Parliament and of the Council amending Regulation (EU) 2019/631 as regards strengthening the CO2 emission performance standards for new passenger cars and new light commercial vehicles in line with the Union's increased climate ambition*. 2021. URL: https://ec.europa.eu/info/sites/default/files/amendment-regulation-co2-emission-standards-cars-vans-with-annexes_en.pdf.
- [4] Popp, D. *Fit for 55: MEPs back objective of zero emissions for cars and vans in 2035*. Euoprean Parliament News. 2022. URL: <https://www.europarl.europa.eu/news/en/press-room/20220603IPR32129/fit-for-55-meps-back-objective-of-zero-emissions-for-cars-and-vans-in-2035>.
- [5] European Environment Agency, *CO2 emissions from new passenger cars registered in EU27, UK, Iceland (from 2018) and Norway (from 2019) – Regulation (EU) 2019/631*. Monitoring of CO2 emissions from passenger cars. 2021.
- [6] Van Mierlo, J., Messagie, M., Rangaraju, S., “Comparative environmental assessment of alternative fueled vehicles using a life cycle assessment.” In: *Transportation Research Procedia* 25 (2017), pp. 3435–3445. ISSN: 23521465. DOI: 10.1016/j.trpro.2017.05.244. URL: <https://linkinghub.elsevier.com/retrieve/pii/S2352146517305513> (visited on 11/19/2019).
- [7] Thomas, M., Ellingsen, L. A.-W., Hung, C. R., *Battery-powered electric vehicles: market development and lifecycle emissions*. Brussels, Belgium: European Parliament’s Committee on Transport and Tourism, 2018. ISBN: 978-92-846-2667-0.
- [8] Bieker, G. *A global comparison of the life-cycle greenhouse gas emissions of combustion engine and electric passenger cars*. Berlin, Germany: International Council on Clean Transportation, 2021, p. 86. URL: https://theicct.org/sites/default/files/publications/Global-LCA-passenger-cars-jul2021_0.pdf.
- [9] Ulica Solar, *Ulica Mono half-cut bifacial modules*. 2021. URL: <http://www.ulicasolar.com>.
- [10] Huawei, *Huawei SUN2000-60KTL-M0 inverter datasheet*. 2020. URL: <https://solar.huawei.com>.
- [11] European Commission Joint Research Centre (JRC), *Photovoltaic Geographical Information System (PVGIS)*. 2022. URL: <https://re.jrc.ec.europa.eu/pvg-tools/en/tools.html>.
- [12] Gilman, P. *SAM Photovoltaic Model Technical Reference*. NREL/TP-6A20-64102, 1215213. 2015, NREL/TP-6A20-64102, 1215213. DOI: 10.2172/1215213. URL: <http://www.osti.gov/servlets/purl/1215213/> (visited on 02/07/2022).
- [13] Duffy, J., Beckman, W., *Solar Engineering of Thermal Processes*. 4th. New York: Wiley, 2013.
- [14] ElaadNL, *Open Datasets for Electric Mobility Research*. 2022. URL: https://platform.elaad.io/analyses/ElaadNL_opendata.php (visited on 07/02/2021).
- [15] Nilar, *Nilar EC Racks - Advanced NiMH battery technology product information*. 2018. URL: <https://www.nilar.com/products/rack/>.

- [16] Nilar, *Nilar Products*. Nilar. 2021. URL: <https://www.nilar.com/products/>.
- [17] Socomec, *SUNSYS-PCS2 product catalogue*. 2018. URL: https://www.socomec.com/range-power-conversion-system-storage_en.html?product=/power-conversion-system-sunsys-pcs2_en.html.
- [18] Manwell, J. F., McGowan, J. G., “Extension of the Kinetic Battery Model for Wind/Hybrid Power Systems.” In: *Proceedings of the 5th European Wind Energy Association Conference (EWEC '94)*. 5th European Wind Energy Association Conference (EWEC '94). Thessaloniki, Macedonia, Greece., 1994, pp. 1182–1187.
- [19] Lilienthal, P. *HOMER Pro*. Version 3.7. Boulder, Colorado, USA, 2016. URL: <https://www.homerenergy.com/pdf/HOMERHelpManual.pdf> (visited on 06/19/2018).
- [20] DiOrto, N., Dobos, A., Janzou, S., Nelson, A., Lundstrom, B., *Technoeconomic Modeling of Battery Energy Storage in SAM*. NREL/TP-6A20-64641. Golden, CO (United States): National Renewable Energy Laboratory (NREL), 2015. DOI: 10.2172/1225314. URL: <http://www.osti.gov/servlets/purl/1225314/>.
- [21] Jongerden, M. R., Haverkort, B. R., “Which battery model to use?” In: *IET Software* 3.6 (2009), pp. 445–457. ISSN: 1751-8806. DOI: 10.1049/iet-sen.2009.0001.
- [22] Chandra Mouli, G., Bauer, P., Zeman, M., “System design for a solar powered electric vehicle charging station for workplaces.” In: *Applied Energy* 168 (2016), pp. 434–443. ISSN: 03062619. DOI: 10.1016/j.apenergy.2016.01.110. URL: <http://linkinghub.elsevier.com/retrieve/pii/S0306261916300988>.
- [23] Figueiredo, R., Nunes, P., Brito, M. C., “The feasibility of solar parking lots for electric vehicles.” In: *Energy* 140 (2017), pp. 1182–1197. ISSN: 03605442. DOI: 10.1016/j.energy.2017.09.024. URL: <http://linkinghub.elsevier.com/retrieve/pii/S0360544217315438>.
- [24] European Commission, *Methodology for GHG Emission Avoidance Calculation*. Brussels, Belgium, 2021. URL: https://ec.europa.eu/info/funding-tenders/opportunities/docs/2021-2027/innovfund/wp-call/call-annex_innovfund-ssc-2020-single-stage_en.pdf (visited on 03/23/2021).
- [25] World Business Council for Sustainable Development and World Resources Institute, eds. *The greenhouse gas protocol: a corporate accounting and reporting standard*. Rev. ed. OCLC: ocm55049070. Geneva, Switzerland : Washington, DC: World Business Council for Sustainable Development ; World Resources Institute, 2004. 112 pp. ISBN: 978-1-56973-568-8.
- [26] Brander, M., Gillenwater, M., Ascui, F., “Creative accounting: A critical perspective on the market-based method for reporting purchased electricity (scope 2) emissions.” In: *Energy Policy* 112 (2018), pp. 29–33. ISSN: 0301-4215. DOI: 10.1016/j.enpol.2017.09.051. URL: <https://www.sciencedirect.com/science/article/pii/S0301421517306213>.
- [27] Peters, G. P. “From production-based to consumption-based national emission inventories.” In: *Ecological Economics* 65.1 (2008), pp. 13–23. ISSN: 0921-8009. DOI: 10.1016/j.ecolecon.2007.10.014. URL: <https://www.sciencedirect.com/science/article/pii/S0921800907005162>.
- [28] Lenzen, M. “Double-Counting in Life Cycle Calculations.” In: *Journal of Industrial Ecology* 12.4 (2008), pp. 583–599. ISSN: 1530-9290. DOI: <https://doi.org/10.1111/j.1530-9290.2008.00067.x>. URL: <https://onlinelibrary.wiley.com/doi/abs/10.1111/j.1530-9290.2008.00067.x>.
- [29] Hawkins, T. R., Singh, B., Majeau-Bettez, G., Strømman, A. H., “Comparative Environmental Life Cycle Assessment of Conventional and Electric Vehicles.” In: *Journal of Industrial Ecology* 17.1 (2013), pp. 53–64. ISSN: 3-936338-34-5. DOI: 10.4229/EUPVSEC20142014-5DV.3.46. URL: <https://onlinelibrary.wiley.com/doi/abs/10.1111/j.1530-9290.2012.00532.x>.
- [30] Edwards, R., Larivé, J.-F., Rickeard, D. J., Weindorf, W., *Well-to-wheels analysis of future automotive fuels and powertrains in the European context: Well-to-tank report version 4.0*. Luxembourg: European Commission Joint Research Centre, Institute for Energy and Transport, 2013. URL: https://publications.jrc.ec.europa.eu/repository/bitstream/JRC82855/wtt%20report%20v4%20july%202013_final.pdf.
- [31] Michalek, J. J., Chester, M., Jaramillo, P., Samaras, C., Shiau, C.-S. N., Lave, L. B., “Valuation of plug-in vehicle life-cycle air emissions and oil displacement benefits.” In: *Proceedings of the National Academy of Sciences* 108.40 (2011), pp. 16554–16558. ISSN: 0027-8424, 1091-6490. DOI: 10.1073/pnas.1104473108. URL: <http://www.pnas.org/cgi/doi/10.1073/pnas.1104473108>.

- [32] Nealer, R., Reichmuth, D., Anair, D., *Cleaner Cars from Cradle to Grave: How Electric Cars Beat Gasoline Cars on Lifetime Global Warming Emissions*. Cambridge, Massachusetts, USA: Union of Concerned Scientists, 2015. URL: <https://www.ucsusa.org/sites/default/files/attach/2015/11/Cleaner-Cars-from-Cradle-to-Grave-full-report.pdf>.
- [33] Johnson, T., Schreifels, J., Dorn, J., Hoer, M., Cooley, D., Siegel, K., Derrick, H., Shenaut, L., *The Emissions and Generation Resource Integrated Database: eGRID Technical Guide with Year 2019 Data*. EP-BPA-17-H-0012. Washington DC, USA: Office of Atmospheric Programs: Clean Air Market Division, 2021, p. 128. URL: https://www.epa.gov/sites/production/files/2021-02/documents/egrid2019_technical_guide.pdf.
- [34] Tamayao, M.-A. M., Michalek, J. J., Hendrickson, C., Azevedo, I. M. L., “Regional Variability and Uncertainty of Electric Vehicle Life Cycle CO₂ Emissions across the United States.” In: *Environmental Science & Technology* 49.14 (2015), pp. 8844–8855. ISSN: 0013-936X, 1520-5851. DOI: 10.1021/acs.est.5b00815. URL: <https://pubs.acs.org/doi/10.1021/acs.est.5b00815>.
- [35] Colett, J. S., Kelly, J. C., Keoleian, G. A., “Using Nested Average Electricity Allocation Protocols to Characterize Electrical Grids in Life Cycle Assessment.” In: *Journal of Industrial Ecology* 20.1 (2016), pp. 29–41. ISSN: 1530-9290. DOI: <https://doi.org/10.1111/jiec.12268>. URL: <https://onlinelibrary.wiley.com/doi/full/10.1111/jiec.12268>.
- [36] Moro, A., Lonza, L., “Electricity carbon intensity in European Member States: Impacts on GHG emissions of electric vehicles.” In: *Transportation Research Part D: Transport and Environment* 64 (2018), pp. 5–14. ISSN: 13619209. DOI: 10.1016/j.trd.2017.07.012. URL: <https://linkinghub.elsevier.com/retrieve/pii/S1361920916307933>.
- [37] Blume-Werry, E., Faber, T., Hirth, L., Huber, C., Everts, M., “Eyes on the Price: Which Power Generation Technologies Set the Market Price?” In: *Economics of Energy & Environmental Policy* Volume 10 (Number 1 2021). Publisher: International Association for Energy Economics. URL: <https://ideas.repec.org/a/aen/eeepjl/eeep10-1-blume-werry.html> (visited on 02/14/2022).
- [38] Denholm, P., Kuss, M., Margolis, R. M., “Co-benefits of large scale plug-in hybrid electric vehicle and solar PV deployment.” In: *Journal of Power Sources* 236 (2013), pp. 350–356. ISSN: 03787753. DOI: 10.1016/j.jpowsour.2012.10.007. URL: <http://linkinghub.elsevier.com/retrieve/pii/S0378775312015534>.
- [39] McLaren, J., Miller, J., O’Shaughnessy, E., Wood, E., Shapiro, E., *Emissions Associated with Electric Vehicle Charging: Impact of Electricity Generation Mix, Charging Infrastructure Availability, and Vehicle Type*. NREL/TP-6A20-64852, 1247645. 2016, NREL/TP-6A20-64852, 1247645. DOI: 10.2172/1247645. URL: <http://www.osti.gov/servlets/purl/1247645/>.
- [40] Ghotge, R., Paanakker, M., Baeten, B., Lukszo, Z., Wijk, A., “The Effect of Price-Optimized Charging on Electric Vehicle Fleet Emissions.” In: 2020 IEEE PES Innovative Smart Grid Technologies Europe (ISGT-Europe). the Hague, the Netherlands: IEEE, 2020, pp. 469–473. ISBN: 978-1-72817-099-2. DOI: 10.1109/ISGT-Europe47291.2020.9248907.
- [41] Curran, M. A., Mann, M., Norris, G., “The international workshop on electricity data for life cycle inventories.” In: *Journal of Cleaner Production* 13.8 (2005), pp. 853–862. ISSN: 0959-6526. DOI: 10.1016/j.jclepro.2002.03.001. URL: <https://www.sciencedirect.com/science/article/pii/S0959652604000460> (visited on 06/01/2022).
- [42] Finnveden, G., Hauschild, M. Z., Ekvall, T., Guinée, J., Heijungs, R., Hellweg, S., Koehler, A., Pennington, D., Suh, S., “Recent developments in Life Cycle Assessment.” In: *Journal of Environmental Management* 91.1 (2009), pp. 1–21. ISSN: 0301-4797. DOI: 10.1016/j.jenvman.2009.06.018. URL: <https://www.sciencedirect.com/science/article/pii/S0301479709002345>.
- [43] European Commission - Joint Research Centre, Institute for Environment and Sustainability, *General guide for Life Cycle Assessment: Provisions and action steps*. Ispra, Italy: Publications Office of the European Union, 2010. ISBN: 978-92-79-15855-1. URL: <https://data.europa.eu/doi/10.2788/94987> (visited on 06/01/2022).
- [44] Brander, M., Ascui, F., “The Attributional-Consequential Distinction and Its Applicability to Corporate Carbon Accounting.” In: *Corporate Carbon and Climate Accounting*. Ed. by S. Schaltegger, D. Zvezdov, I. Alvarez Etxeberria, M. Csutora, and E. Günther. Cham: Springer International Publishing, 2015, pp. 99–120. ISBN: 978-3-319-27718-9. DOI: 10.1007/978-3-319-27718-9_5. URL: https://doi.org/10.1007/978-3-319-27718-9_5.

- [45] Harmsen, R., Graus, W., “How much CO₂ emissions do we reduce by saving electricity? A focus on methods.” In: *Energy Policy* 60 (2013), pp. 803–812. ISSN: 03014215. DOI: 10.1016/j.enpol.2013.05.059. URL: <https://linkinghub.elsevier.com/retrieve/pii/S0301421513003959>.
- [46] Verzijlbergh, R. A., Lukszo, Z., “System impacts of electric vehicle charging in an evolving market environment.” In: *2011 International Conference on Networking, Sensing and Control*. 2011 International Conference on Networking, Sensing and Control. ISSN: null. 2011, pp. 20–25. DOI: 10.1109/ICNSC.2011.5874924.
- [47] Schram, W. L., AlSkaif, T., Lampropoulos, I., Henein, S., Sark, W. G., “On the Trade-Off Between Environmental and Economic Objectives in Community Energy Storage Operational Optimization.” In: *IEEE Transactions on Sustainable Energy* 11.4 (2020), pp. 2653–2661. ISSN: 1949-3029, 1949-3037. DOI: 10.1109/TSTE.2020.2969292. URL: <https://ieeexplore.ieee.org/document/8970409/>.
- [48] Ensslen, A., Schücking, M., Jochem, P., Steffens, H., Fichtner, W., Wollersheim, O., Stella, K., “Empirical carbon dioxide emissions of electric vehicles in a French-German commuter fleet test.” In: *Journal of Cleaner Production*. Cleaner production towards a sustainable transition 142 (2016), pp. 263–278. ISSN: 0959-6526. DOI: 10.1016/j.jclepro.2016.06.087. URL: <http://www.sciencedirect.com/science/article/pii/S0959652616307648>.
- [49] Jochem, P., Babrowski, S., Fichtner, W., “Assessing CO₂ emissions of electric vehicles in Germany in 2030.” In: *Transportation Research Part A: Policy and Practice* 78 (2015), pp. 68–83. ISSN: 0965-8564. DOI: 10.1016/j.tra.2015.05.007. URL: <http://www.sciencedirect.com/science/article/pii/S0965856415001354>.
- [50] Baumgärtner, N., Delorme, R., Hennen, M., Bardow, A., “Design of low-carbon utility systems: Exploiting time-dependent grid emissions for climate-friendly demand-side management.” In: *Applied Energy* 247 (2019), pp. 755–765. ISSN: 0306-2619. DOI: 10.1016/j.apenergy.2019.04.029. URL: <https://www.sciencedirect.com/science/article/pii/S0306261919306609>.
- [51] Graff Zivin, J. S., Kotchen, M. J., Mansur, E. T., “Spatial and temporal heterogeneity of marginal emissions: Implications for electric cars and other electricity-shifting policies.” In: *Journal of Economic Behavior & Organization* 107 (2014), pp. 248–268. ISSN: 01672681. DOI: 10.1016/j.jebo.2014.03.010. URL: <https://linkinghub.elsevier.com/retrieve/pii/S0167268114000808>.
- [52] Hawkes, A. D. “Estimating marginal CO₂ emissions rates for national electricity systems.” In: *Energy Policy*. The socio-economic transition towards a hydrogen economy - findings from European research, with regular papers 38.10 (2010), pp. 5977–5987. ISSN: 0301-4215. DOI: 10.1016/j.enpol.2010.05.053. URL: <http://www.sciencedirect.com/science/article/pii/S0301421510004246>.
- [53] Arnas, A. O., Boettner, D. D., Bailey, M. B., “On the Sign Convention in Thermodynamics: An Asset or an Evil?” In: ASME 2003 International Mechanical Engineering Congress and Exposition. American Society of Mechanical Engineers Digital Collection, 2008, pp. 151–161. DOI: 10.1115/IMECE2003-41048. URL: <https://asmedigitalcollection.asme.org/IMECE/proceedings/IMECE2003/37084/151/300360> (visited on 06/17/2022).
- [54] Myhre, G. “Anthropogenic and Natural Radiative Forcing.” In: *Climate Change 2013: The Physical Science Basis. Contribution of Working Group I to the Fifth Assessment Report of the Intergovernmental Panel on Climate Change*. Cambridge, UK and New York, NY, USA: Cambridge University Press, 2013, p. 82. ISBN: ISBN 978-1-107-66182-0. URL: https://www.ghgprotocol.org/sites/default/files/ghgp/Global-Warming-Potential-Values%20%28Feb%2016%202016%29_1.pdf.
- [55] Tomorrow, *tmrowco/electricitymap-contrib*. 2020. URL: <https://github.com/tmrowco/electricitymap-contrib>.
- [56] International Energy Agency, *Electricity Information*. IEA. 2022. URL: <https://www.iea.org/data-and-statistics/data-product/electricity-information>.
- [57] b.V. T. T. *TenneT Annual Market Update 2019*. Arnhem, the Netherlands, 2020. URL: https://www.tennet.eu/fileadmin/user_upload/Company/Publications/Technical_Publications/TenneT_Annual_Market_Update_2019.pdf (visited on 03/23/2021).
- [58] Tranberg, B., Corradi, O., Lajoie, B., Gibon, T., Staffell, I., Andresen, G. B., “Real-time carbon accounting method for the European electricity markets.” In: *Energy Strategy Reviews* 26 (2019), p. 100367. ISSN: 2211467X. DOI: 10.1016/j.esr.2019.100367. URL: <https://linkinghub.elsevier.com/retrieve/pii/S2211467X19300549>.

- [59] Corradi, O. *Estimating the marginal carbon intensity of electricity with machine learning - Tomorrow Blog*. Tomorrow Blog. 2018. URL: <https://www.tmrow.com/blog/marginal-carbon-intensity-of-electricity-with-machine-learning/> (visited on 03/17/2021).
- [60] Tranberg, B., Corradi, O., Lajoie, B., Gibon, T., Staffell, I., Bruun, G., “Supplementary material to: Real-Time Carbon Accounting Method for the European Electricity Markets.” In: *Energy Strategy Reviews* 26 (2019), p. 100367. ISSN: 2211467X. DOI: 10.1016/j.esr.2019.100367. URL: <https://ars.els-cdn.com/content/image/1-s2.0-S2211467X19300549-mmc1.pdf>.
- [61] Hsu, D. D., O’Donoghue, P., Fthenakis, V., Heath, G. A., Kim, H. C., Sawyer, P., Choi, J.-K., Turney, D. E., “Life Cycle Greenhouse Gas Emissions of Crystalline Silicon Photovoltaic Electricity Generation.” In: *Journal of Industrial Ecology* 16 (s1 2012), S122–S135. ISSN: 1530-9290. DOI: <https://doi.org/10.1111/j.1530-9290.2011.00439.x>. URL: <https://onlinelibrary.wiley.com/doi/abs/10.1111/j.1530-9290.2011.00439.x>.
- [62] Fthenakis, V., Leccisi, E., “Updated sustainability status of crystalline silicon-based photovoltaic systems: Life-cycle energy and environmental impact reduction trends.” In: *Progress in Photovoltaics: Research and Applications* 29.10 (2021), pp. 1068–1077. ISSN: 1099-159X. DOI: 10.1002/pip.3441. URL: <https://onlinelibrary.wiley.com/doi/abs/10.1002/pip.3441>.
- [63] Frischknecht, R., Stolz, P., Krebs, L., Wild-Scholten, M., Sinha, P., *Life Cycle Inventories and Life Cycle Assessments of Photovoltaic Systems*. IEA-PVPS T12-19:2020. International Energy Agency Photovoltaics Power Systems Programme, 2020. DOI: 10.2172/1561526. URL: <http://www.osti.gov/servlets/purl/1561526/>.
- [64] Jia, X., Zhou, C., Tang, Y., Wang, W., “Life cycle assessment on PERC solar modules.” In: *Solar Energy Materials and Solar Cells* 227 (2021), p. 111112. ISSN: 0927-0248. DOI: 10.1016/j.solmat.2021.111112. URL: <https://www.sciencedirect.com/science/article/pii/S0927024821001549> (visited on 05/30/2022).
- [65] Silvestri, L., Forcina, A., Arcese, G., Bella, G., “Recycling technologies of nickel–metal hydride batteries: An LCA based analysis.” In: *Journal of Cleaner Production* 273 (2020), p. 123083. ISSN: 0959-6526. DOI: 10.1016/j.jclepro.2020.123083. URL: <https://www.sciencedirect.com/science/article/pii/S0959652620331280>.
- [66] Tong, S. J., Same, A., Kootstra, M. A., Park, J. W., “Off-grid photovoltaic vehicle charge using second life lithium batteries: An experimental and numerical investigation.” In: *Applied Energy* 104 (2013), pp. 740–750. ISSN: 0306-2619. DOI: 10.1016/j.apenergy.2012.11.046. URL: <http://www.sciencedirect.com/science/article/pii/S0306261912008495>.
- [67] Ministerie van Economische Zaken en Klimaat, *Kabinet stelt met SDE++ €5 miljard beschikbaar voor CO₂-reductie*. Rijksoverheid.nl. 2020. URL: <https://www.rijksoverheid.nl/actueel/nieuws/2020/02/17/kabinet-stelt-met-sde-%E2%82%AC5-miljard-beschikbaar-voor-co%E2%82%82-reductie>.
- [68] Netherlands Enterprise Agency (RVO), *SDE++ 2021 Stimulation of Sustainable Energy Production and Climate Transition*. The Hague, the Netherlands: Netherlands Ministry of Economic Affairs and Climate Policy, 2021. URL: https://english.rvo.nl/sites/default/files/2021/10/SDEplusplus_oktober_2021_ENG.pdf.
- [69] Louwen, A., Sark, W. G. J. H. M., Faaij, A. P. C., Schropp, R. E. I., “Re-assessment of net energy production and greenhouse gas emissions avoidance after 40 years of photovoltaics development.” In: *Nature Communications* 7.1 (2016). Number: 1 Publisher: Nature Publishing Group, p. 13728. ISSN: 2041-1723. DOI: 10.1038/ncomms13728. URL: <https://www.nature.com/articles/ncomms13728>.
- [70] Luo, W., Khoo, Y. S., Kumar, A., Low, J. S. C., Li, Y., Tan, Y. S., Wang, Y., Aberle, A. G., Ramakrishna, S., “A comparative life-cycle assessment of photovoltaic electricity generation in Singapore by multicrystalline silicon technologies.” In: *Solar Energy Materials and Solar Cells* 174 (2018), pp. 157–162. ISSN: 0927-0248. DOI: 10.1016/j.solmat.2017.08.040. URL: <https://www.sciencedirect.com/science/article/pii/S0927024817304877>.
- [71] Leccisi, E., Raugei, M., Fthenakis, V., “The Energy and Environmental Performance of Ground-Mounted Photovoltaic Systems—A Timely Update.” In: *Energies* 9.8 (2016). Number: 8 Publisher: Multidisciplinary Digital Publishing Institute, p. 622. DOI: 10.3390/en9080622. URL: <https://www.mdpi.com/1996-1073/9/8/622>.
- [72] Wild-Scholten, M., Cassagne, V., Huld, T., “Solar resources and carbon footprint of photovoltaic power in different regions in Europe.” In: *Proceedings of 29th European Photovoltaic Solar Energy Conference*. EUPVSEC. Munich, Germany: WIP, 2014, p. 3421–3430. ISBN: 3-936338-34-5. DOI: <http://dx.doi.org/10.4229/EUPVSEC20142014-5DV.3.46>. URL: <http://www.eupvsec-proceedings.com/proceedings?paper=28188>.

- [73] Wang, S., Yu, J., Okubo, K., “Life cycle assessment on the reuse and recycling of the nickel-metal hydride battery: Fleet-based study on hybrid vehicle batteries from Japan.” In: *Journal of Industrial Ecology* 25.5 (2021), pp. 1236–1249. ISSN: 1530-9290. DOI: 10.1111/jiec.13126. URL: <https://onlinelibrary.wiley.com/doi/abs/10.1111/jiec.13126>.
- [74] Mahmud, M. A. P., Huda, N., Farjana, S. H., Lang, C., “Comparative Life Cycle Environmental Impact Analysis of Lithium-Ion (LiIo) and Nickel-Metal Hydride (NiMH) Batteries.” In: *Batteries* 5.1 (2019). Number: 1 Publisher: Multidisciplinary Digital Publishing Institute, p. 22. DOI: 10.3390/batteries5010022. URL: <https://www.mdpi.com/2313-0105/5/1/22>.
- [75] Majeau-Bettez, G., Hawkins, T. R., Strømman, A. H., “Life Cycle Environmental Assessment of Lithium-Ion and Nickel Metal Hydride Batteries for Plug-In Hybrid and Battery Electric Vehicles.” In: *Environmental Science & Technology* 45.10 (2011). Publisher: American Chemical Society, pp. 4548–4554. ISSN: 0013-936X. DOI: 10.1021/es103607c. URL: <https://doi.org/10.1021/es103607c>.

THE EFFECT OF PRICE-OPTIMISED CHARGING ON EV FLEET EMISSIONS

Abstract

Aggregation of sufficiently large electric vehicle (EV) fleets and control over their charging schedules enables aggregators to utilise the flexibility of EV charging in the Day Ahead Market. Optimising the charge scheduling of such fleets enables time-shifting of electricity demand to hours when electricity is cheaper, reducing the electricity cost for charging the entire fleet. Time shifting with scheduled charging is expected to influence the average carbon intensity of the energy used by these vehicles. This work aims to quantify the change in the carbon intensity of energy used by vehicles whose charging was scheduled. It uses real data collected from over 55,000 home charging sessions from 1031 charge points in the Netherlands in 2018. A simulation was made with a commercial scheduled charging algorithm to create a scheduled charging profile ex post from the historic EV charging dataset. The simulation resulted in an average price reduction of electricity for the fleet of about 25% relative to unscheduled charging of the same fleet over the same period. The time dependent average carbon intensity of electricity consumed in the Netherlands was used to calculate the mean carbon intensity of the electricity used to charge the fleet over the period in the scheduled and unscheduled charging cases. The results revealed a small decrease in carbon intensity by 1.2%. Analysis reveals that price optimisation can have large effects on the mean carbon intensity of individual sessions in the Dutch grid, but the net effect is averaged out over a large number of sessions and over the year.

This chapter is adapted from **Ghotge, R.**, Paanakker, M., Baeten, B., Lukszo, Z., Wijk, A., “The Effect of Price-Optimized Charging on Electric Vehicle Fleet Emissions.” In: 2020 IEEE PES Innovative Smart Grid Technologies Europe (ISGT-Europe). the Hague, the Netherlands: IEEE, 2020, pp. 469–473. ISBN: 978-1-72817-099-2. DOI: 10.1109/ISGT-Europe47291.2020.9248907

6.1 INTRODUCTION

In order to reduce emissions in the passenger mobility sector, average emissions of new vehicles in the EU are required to be limited to $95 \text{ gCO}_2\text{eq./km}$ [1]. Based on the EU electricity mix, EVs result in about 20% lower emissions over their lifetimes than internal combustion engine based vehicles based on LCAs [2, 3]. The adoption of EVs is thus widely supported as part of the shift to lower emission mobility.

Currently, most EVs charge in an unscheduled manner, beginning to charge as soon as they are plugged in. The alternative is scheduled charging, whereby the charging profile is altered based on external data input. Scheduled charging is seen as essential once the fleet share of electric vehicles increases beyond a critical fraction. Alteration of the charging profile can allow vehicles to charge in response to price signals, to contribute to maintaining local voltage quality, reduce congestion in the distribution level network and to provide frequency reserves, among other services [4]. Scheduled charging to reduce the cost of EV charging is already a reality with aggregated groups of EVs participating in energy spot markets [5, 6].

Twenty-five of the twenty-six European aggregators surveyed by Poplavskaya and Vries [6] were found to include participation in energy markets as part of their value proposition. Although the share of aggregated fleets is currently small, it is expected to rise in the future, together with the market share of EVs. Since the carbon intensity in the electricity grid varies with time, scheduled charging of fleets according to market prices is expected to have an effect on the net emissions of the fleet. The net emissions caused by use of EVs is highly dependent on the emissions caused by the generation mix of electricity used i.e. the WTT emissions [7, 8]. As such, estimation of this effect is of considerable interest for accurate assessment of current and future mobility related emissions.

This chapter aims to answer the question:

How does the price-based scheduling of electric vehicle charging in the current Dutch grid affect the CO_2 emissions of the electricity used by the scheduled fleet?

A data-driven methodology is adopted in this investigation. We use charging data of around 55,000 unscheduled charging sessions of over 700 Dutch Battery Electric Vehicles (BEVs) in 2018. A commercial scheduled charging algorithm is used to build a new profile for the fleet ex post based on market based price optimised charging. The volume of electricity charged to EVs per charging session remains unchanged relative to the unscheduled case. The hourly emission intensity based on electricity consumed in the Dutch grid was used with the original and new profiles to calculate the mean carbon intensity of electricity consumed by the unscheduled and scheduled fleets.

The paper is structured as follows: section 6.2 presents a description of the set-up considered and the data used. Section 6.3 describes the methods used for setting up the

optimisation and the calculation of the emissions. Section 7.4 provides the results and discusses their significance. Finally, Section 6.5 presents the conclusions of this work.

6.2 SYSTEM CONSIDERED AND SCOPE

We consider 1031 electric vehicle charge points at residential locations in the Netherlands. Data was collected over eleven months in 2018 (data from August was not available) from these charge points. The charge points included single-phase charging with 16 and 32 A rated cables as well as three-phase charging with 16 A rated cables. They were used by both BEVs and PHEVs, which were part of a leased EV fleet. The Well-to-Tank emissions of PHEVs are also influenced by the crude oil pathways for gasoline and diesel delivery in addition to the electricity factors associated with electric charging. Since estimation of the emissions associated with fossil fuel pathways was considered out of the scope of this work, PHEVs were not considered in this study. The vehicle charging was unscheduled and charging session data was logged by the charge points for billing purposes.

We do not consider a specific EV fleet since there is no information on charging sessions of vehicles at charge points outside the 1031 under consideration. The scope, calculations and conclusions with regards to energy related emissions are therefore limited to the energy charged with these charge points. Three data sets were used in this study:

1. EV charge point data
2. Electricity market data
3. Time dependent carbon intensity data

6.2.1 EV CHARGE POINT DATA

The data collected during every charging session is shown in Table 6.1

Certain charging sessions were considered to be the result of logging errors and were excluded from the dataset. The conditions for their exclusion from the dataset are given in Table 6.2.

The charging volumes lower than 1 kWh were expected to be cases where the user plugged in the vehicle by mistake and are therefore disregarded. Since the largest battery energy capacity among the vehicles considered in the study was that of the Tesla Model S at 100 kWh, it is not possible for charging volumes to have been larger than 100 kWh within a single plug-in session. Hence these values were excluded. Plug-in duration exceeding 24 hours were expected to be caused by users leaving the cables permanently plugged in rather than placing them in the vehicle when driving away. These could also

Table 6.1: EV charge point data overview

No.	Charge point data
1	Unique charging session identifier
2	Unique charge point identifier
3	Unique vehicle charging pass identifier
4	Plug-in time
5	Plug-out time
6	Session plug-in duration
7	Session charging volume

Table 6.2: Overview of conditions for exclusion of charge point data

No.	Condition for exclusion
1	Session charging volume <1 kWh
2	Session charging volume >100 kWh
3	Session plug-in duration >24 h
4	Missing data

have led to sessions with volumes greater than 100 kWh as they included many consecutive sessions. Since these sessions did not really represent the availability of the vehicle, they were left out. Finally, sessions where data from the charge point was missing in the data set were removed so as not to bias the results.

The processed dataset used in this study finally consisted of 55,610 BEV charging sessions.

6.2.2 ELECTRICITY MARKET PRICE DATA

The BEVs were scheduled to optimise their charging cost on the Dutch Day Ahead Market (DAM) prices for the year 2018. This data set was taken from the European Network of Transmission System Operators for Electricity (ENTSO-E) for the year 2018 [9]. The Dutch Day Ahead Markets are currently open for aggregators to participate in with sufficiently large EV fleets.

6.2.3 TIME DEPENDENT CARBON INTENSITY DATA

We use the time dependent carbon intensity data of electricity in the Dutch grid from the open source project electricityMap Live. These values are based on realtime monitoring of power plants with hourly time resolution and take cross-border trade into account. The values account for emissions arising from the entire lifecycle of power plants involved, from construction to decommissioning. They are based on consumption of electricity rather than generation, which can create differences in numbers. Additional information on the data sources and methodology may be found in [10, 11].

A scatter plot of the Dutch Day Ahead Market prices and the time dependent carbon intensity in the year 2018 is shown in Fig. 6.1 to illustrate the relation between these variables in the Dutch grid.

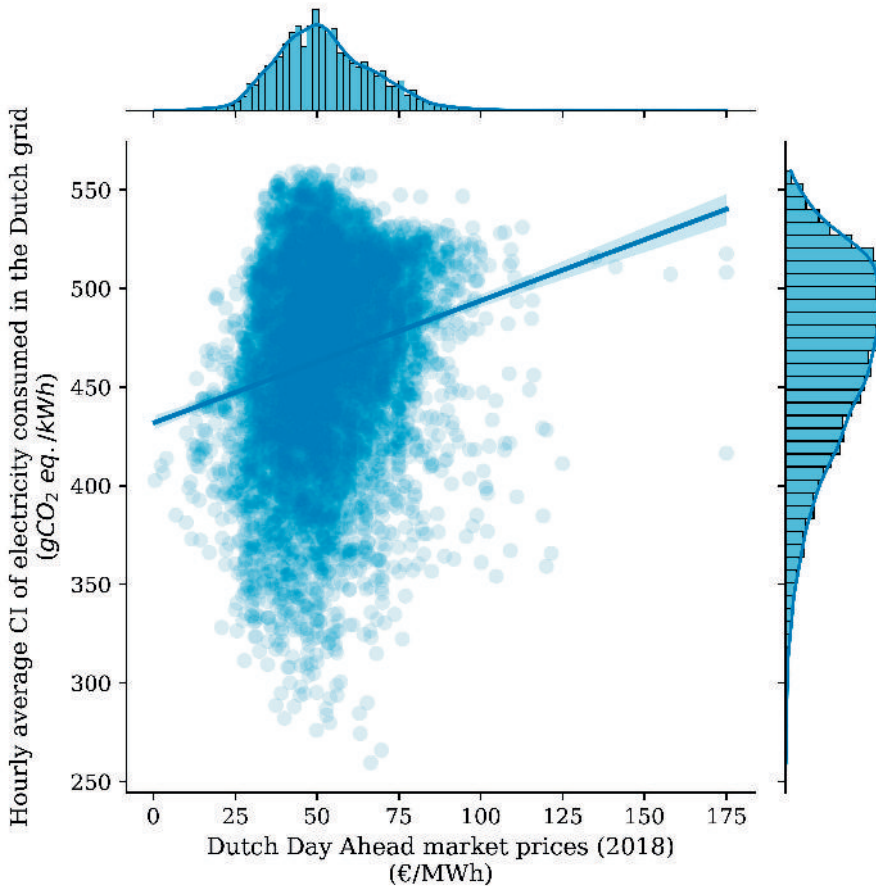

Figure 6.1: Carbon intensity vs. Dutch Day Ahead Market prices in 2018

The correlation between the hourly average carbon intensity in the Dutch grid and the day ahead market prices is not strong - the Pearson correlation coefficient between the two quantities over the 8760 values obtained for 2018 was calculated to be 0.19.

6.3 METHODS

This study consists of two different phases, each with its own methodology. In section 6.3.1, we describe the use of historic EV charging data to generate a cost optimised charging profile ex post for the plugged-in fleet. In section 6.3.2, we describe the methods used to calculate the mean carbon intensity of electricity consumed by the EV fleet.

6.3.1 EX POST EV SCHEDULING

In this work, historic data was used to simulate real-time scheduled charging behaviour using a scheduling algorithm made by the commercial aggregator, Enervalis [12]. The process carried out is shown in Fig. 6.2. Initially, the Day Ahead Market prices together with the entry and exit times and electricity loads were input to the algorithm. A schedule was made for the EVs, whose aggregated demand volume was optimised for the lowest cost over the scheduling horizon (24 hours). In the charging sessions of individual EVs, the charging profile was assumed to follow the profile created as part of the collective schedule. The scheduling of the fleet resulted in an overall cost reduction of about 25% for charging the fleet over the year.

A Python script was used on an Ubuntu based laptop with an Intel® Core™ i7-7700HQ 2.80GHz CPU with 16 GB RAM. The problem was formulated as a Mixed Integer Linear Programming (MILP) problem and was solved using the open source CBC solver to less than 1% optimality gap. Eleven months of data were run as a simulation in this manner to produce the scheduled charging profiles of each charging session.

6.3.2 CALCULATION OF CARBON INTENSITIES

The aim of this study is not carbon accounting for the entire fleet or on a per-vehicle basis but rather to quantify the relative change in emissions as a result of scheduled charging. Thus, we use the indicator of carbon intensity (CI), which we define as ‘the total greenhouse gas emissions emitted per unit electricity consumed’ measured in grams of $CO_2eq./kWh$ [13].

Most studies consider average annual values of CI to measure the emissions impact of the electricity [14]. This is primarily because it is a straightforward approach, understandable for stakeholders and can be easily performed ex-post with low data

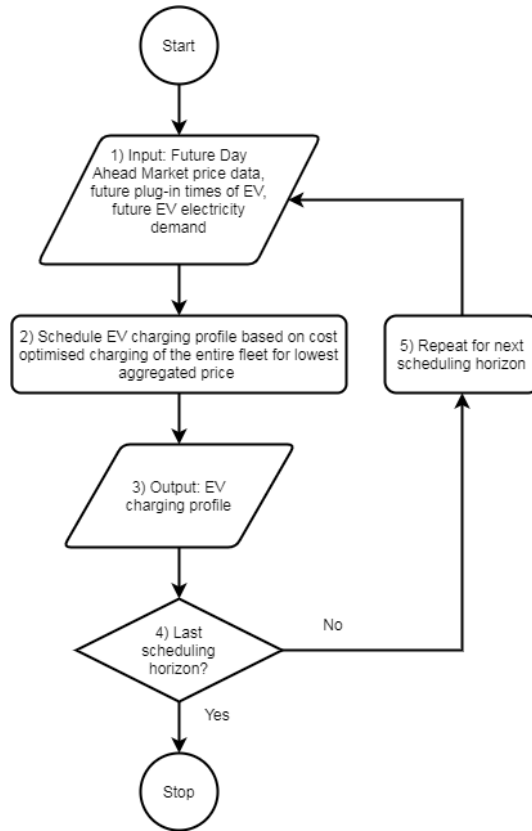

Figure 6.2: Scheduling for each historic charging session

requirements. However, in countries where power plant portfolios having a mix of fossil fuels and variable renewable energies, there can be significant temporal variation (daily, weekly and seasonal) in the carbon intensity of electricity in the grid [15]. In our case, the time of charged electricity rather than its volume, is influenced by the scheduling. A purely volume-based approach, such as the annual average CI value, is not suitable for our case since there would be no change in emissions based on scheduling.

The use of carbon intensity which is based on the time dependent average electricity mix can lead to improved accuracy in the assessment of fleet related emissions [14]. The drawback of such an approach is that it does not consider the marginal emissions caused due to increased load at a given timestep, which depends upon the price-based merit order of power plants within the energy mix at each timestep as well as the capacity constraints of the highest cost deployed powerplant [16].

Calculation of the marginal emissions, however, requires either accurate energy modelling of the grid including the market dispatch or detailed data of local energy markets [14]. Further, there are many factors due to which the dispatch of powerplants is

decided apart from merit order, including plant availability, transmission constraints and powerplant operational logistics [17]. Such an approach was considered out of the scope of this work. As such, we use the CI based on the time dependent average electricity mix. It is an approach which is well-suited for local analyses [18], as is the case here. Implicit in this approach is the assumption that the load profile being changed is not large enough to cause structural change in the electricity system under analysis. As our system is relatively small: 1031 charge points in the Dutch national grid, we take this assumption to be valid.

For every electric vehicle charging session, we multiply the energy demand in each hour by the carbon intensity in that hour to get the net hourly emissions. The summed value across all sessions is then divided by the net energy demand to calculate the mean CI of electricity used. Mathematically, the average CI for m charging sessions, each of which lasted n hours, are calculated as:

$$CI = \frac{\sum_{i=1}^m \sum_{j=1}^n Cl_j E_{ij}}{\sum_{i=1}^m \sum_{j=1}^n E_{ij}} \quad (6.1)$$

where E_{ij} is the energy demand of the i^{th} charge point at the j^{th} hour of the session in kWh

and Cl_j is the carbon intensity of electricity consumed in the Dutch grid at the j^{th} hour of the session in $g.CO_2eq./kWh$

6.4 RESULTS AND DISCUSSIONS

The mean carbon intensity of electricity used by the unscheduled BEVs was calculated to be $464 gCO_2eq./kWh$, a value slightly lower than the annual average value of the Dutch grid, $468 gCO_2eq./kWh$. The mean carbon intensity of electricity used by EVs scheduled according to prices in the Dutch Day Ahead markets was slightly lower, at $459 gCO_2eq./kWh$. The effect of scheduling thus resulted in a 1.2% reduction in the mean carbon intensity of the electricity used - a relatively small change.

Given the data used and methodology, in the present Dutch scenario, the use of time dependent values of carbon intensity together with the charging times rather than average annual values with charging volumes does not make a large difference. This remains the case for both unscheduled and scheduled charging. In our approach, where the final value of carbon intensity was weighted by the hourly values and volumes when EVs were charged, the final results proved quite similar. This provides a validation of earlier studies considering annual average CI values. However, it should be noted that this is a reflection on the Dutch case rather than the methodology, as the use of time dependent CI values is expected to provide a better estimation of the Well-to-Tank emissions of electric vehicles.

Initial investigation suggests that the price optimisation of charging does not lead to large deviation from unscheduled charging in terms of mean carbon intensity. However, the annual mean value across all sessions does not reveal the variation in carbon intensities in individual charging sessions. Fig. 6.3 shows the difference in session CI between the scheduled and unscheduled cases.

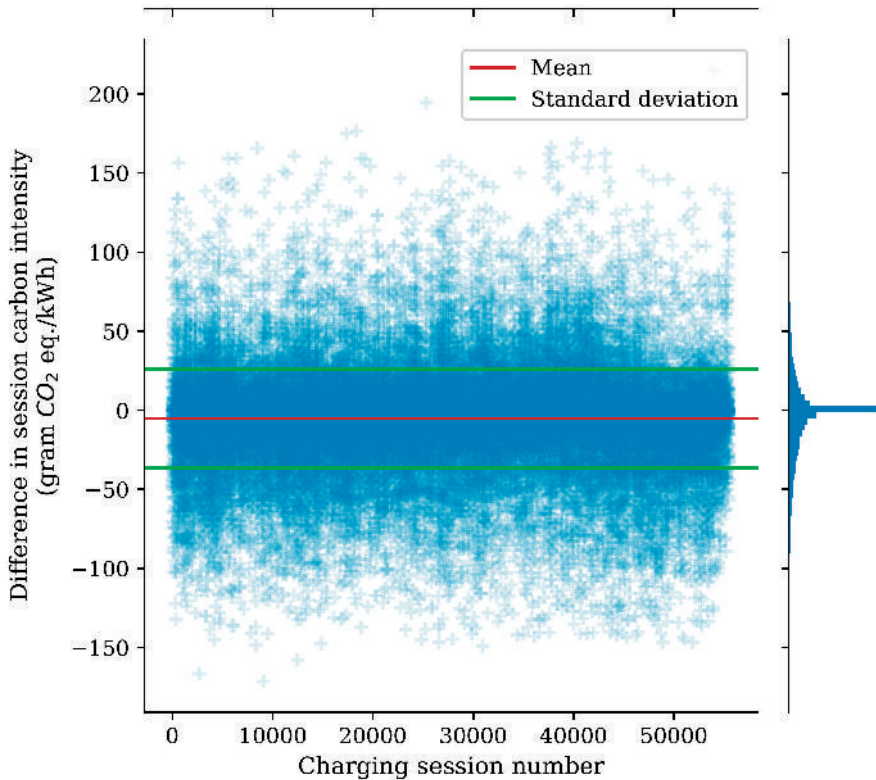

Figure 6.3: Difference in carbon intensity between scheduled session and unscheduled sessions over all sessions considered

Fig. 6.3 shows that the effect of scheduled charging on the mean CI of individual sessions can be significant. The mean CI may increase or decrease in individual sessions, but these are balanced out over a large number of sessions and over the year. It reveals that price optimisation does have an effect on the reduction of CO_2 emissions, but only under certain conditions. Identification of the conditions under which price optimisation

reduces CO_2 emissions may help scheduling of charging achieve multiple objectives and suggests a direction for further research.

The results further raise interesting questions related to the impact of price based charging in grids which include a greater fraction of renewable electricity. Higher price volatility may also be considered as an influencing factor on the emissions impacts of price based charging. Such investigations can lead to interesting future work.

6.5 CONCLUSIONS

This chapter aims to investigate the effect of price optimised scheduled charging on the mean carbon intensity of EVs charged in the Dutch fleet. A data driven method is adopted, making use of the EV charging data of 1031 charge points at residential locations in the Netherlands over a year. A commercial charge scheduling algorithm was used to generate a new EV charging profile optimised for the Dutch Day Ahead market prices. The same volume of electricity was charged to the vehicles in both cases.

Time dependent average electricity mix based carbon intensity was used to calculate the mean carbon intensity of electricity over all the sessions in the two profiles. The results reveal that the use of time dependent carbon intensity does not have a large influence on the mean carbon intensity used by EVs in the Dutch situation, unscheduled or otherwise. Scheduling of charging based on price resulted in a small reduction of mean carbon intensity by 1.2%. The mean carbon intensity of individual sessions is found to vary considerably with price optimisation, but over a large number of sessions and periods of the year, scheduling does not have significant influence on mean carbon intensity of electricity consumed. Consideration of other schedules, locations with higher renewable shares and deeper analysis into the findings here represent avenues for future research.

REFERENCES

- [1] The European Parliament and the Council of the European Union, *Regulation (EU) 2019/ 631 of the European Parliament and of the Council of 17 April 2019 - setting CO2 emission performance standards for new passenger cars and for new light commercial vehicles, and repealing Regulations (EC) No 443 / 2009 and (EU) No 510 / 2011*. 2019. URL: <https://eur-lex.europa.eu/legal-content/EN/TXT/PDF/?uri=CELEX:32019R0631&from=EN>.
- [2] Hawkins, T. R., Singh, B., Majeau-Bettez, G., Strømman, A. H., “Comparative Environmental Life Cycle Assessment of Conventional and Electric Vehicles.” In: *Journal of Industrial Ecology* 17.1 (2013), pp. 53–64. ISSN: 3-936338-34-5. DOI: 10.4229/EUPVSEC20142014-5DV.3.46. URL: <https://onlineibrary.wiley.com/doi/abs/10.1111/j.1530-9290.2012.00532.x>.
- [3] Thomas, M., Ellingsen, L. A.-W., Hung, C. R., *Battery-powered electric vehicles: market development and lifecycle emissions*. Brussels, Belgium: European Parliament’s Committee on Transport and Tourism, 2018. ISBN: 978-92-846-2667-0.
- [4] Verzijlbergh, R. A., Grond, M. O. W., Lukszo, Z., Slootweg, J. G., Ilic, M. D., “Network Impacts and Cost Savings of Controlled EV Charging.” In: *IEEE Transactions on Smart Grid* 3.3 (2012), pp. 1203–1212. ISSN: 1949-3053, 1949-3061. DOI: 10.1109/TSG.2012.2190307. URL: <http://ieeexplore.ieee.org/document/6204213/> (visited on 02/20/2020).
- [5] Berkel, T., Heesbeen, J., “Smart charging with app solutions.” In: *ATZelextronik worldwide* 12.6 (2017), pp. 42–45. ISSN: 2192-9092. DOI: 10.1007/s38314-017-0078-2. URL: <https://doi.org/10.1007/s38314-017-0078-2> (visited on 02/20/2020).
- [6] Poplavskaya, K., Vries, L., “Chapter 5 - Aggregators today and tomorrow: from intermediaries to local orchestrators?” In: *Behind and Beyond the Meter*. Ed. by F. Sioshansi. Academic Press, 2020, pp. 105–135. ISBN: 978-0-12-819951-0. DOI: 10.1016/B978-0-12-819951-0.00005-0. URL: <http://www.sciencedirect.com/science/article/pii/B9780128199510000050>.
- [7] Van Mierlo, J., Messagie, M., Rangaraju, S., “Comparative environmental assessment of alternative fueled vehicles using a life cycle assessment.” In: *Transportation Research Procedia* 25 (2017), pp. 3435–3445. ISSN: 23521465. DOI: 10.1016/j.trpro.2017.05.244. URL: <https://linkinghub.elsevier.com/retrieve/pii/S2352146517305513> (visited on 11/19/2019).
- [8] Sternberg, A., Hank, C., Hebling, C., *Greenhouse Gas Emissions for Battery Electric and Fuel Cell Electric Vehicles with Ranges over 300 km*. Freiburg, Germany: Fraunhofer Institute for Solar Energy Systems, 2019, p. 32. URL: https://www.ise.fraunhofer.de/content/dam/ise/en/documents/News/190815_LCA-BEV-FCEV-Results-EnglishVersion.pdf.
- [9] ENTSO-E, *ENTSO-E Transparency Platform*. URL: <https://transparency.entsoe.eu/> (visited on 09/03/2018).
- [10] Tranberg, B., Corradi, O., Lajoie, B., Gibon, T., Staffell, I., Andresen, G. B., “Real-time carbon accounting method for the European electricity markets.” In: *Energy Strategy Reviews* 26 (2019), p. 100367. ISSN: 2211467X. DOI: 10.1016/j.esr.2019.100367. URL: <https://linkinghub.elsevier.com/retrieve/pii/S2211467X19300549>.
- [11] Tomorrow, *tmrowco/electricitymap-contrib*. 2020. URL: <https://github.com/tmrowco/electricitymap-contrib>.
- [12] Enervalis, *Smart EV Charging – Enervalis*. 2020. URL: <https://www.enervalis.com/smart-ev-charging/> (visited on 02/27/2020).
- [13] Moro, A., Lonza, L., “Electricity carbon intensity in European Member States: Impacts on GHG emissions of electric vehicles.” In: *Transportation Research Part D: Transport and Environment* 64 (2018), pp. 5–14. ISSN: 13619209. DOI: 10.1016/j.trd.2017.07.012. URL: <https://linkinghub.elsevier.com/retrieve/pii/S1361920916307933>.

- [14] Jochem, P., Babrowski, S., Fichtner, W., "Assessing CO2 emissions of electric vehicles in Germany in 2030." In: *Transportation Research Part A: Policy and Practice* 78 (2015), pp. 68–83. ISSN: 0965-8564. DOI: 10.1016/j.tra.2015.05.007. URL: <http://www.sciencedirect.com/science/article/pii/S0965856415001354>.
- [15] Lowry, G. "Day-ahead forecasting of grid carbon intensity in support of heating, ventilation and air-conditioning plant demand response decision-making to reduce carbon emissions." In: *Building Services Engineering Research and Technology* 39.6 (2018), pp. 749–760. ISSN: 0143-6244. DOI: 10.1177/0143624418774738. URL: <https://doi.org/10.1177/0143624418774738> (visited on 02/24/2020).
- [16] Verzijlbergh, R. A., Lukszo, Z., "System impacts of electric vehicle charging in an evolving market environment." In: *2011 International Conference on Networking, Sensing and Control*. 2011 International Conference on Networking, Sensing and Control. ISSN: null. 2011, pp. 20–25. DOI: 10.1109/ICNSC.2011.5874924.
- [17] Hawkes, A. D. "Estimating marginal CO2 emissions rates for national electricity systems." In: *Energy Policy*. The socio-economic transition towards a hydrogen economy - findings from European research, with regular papers 38.10 (2010), pp. 5977–5987. ISSN: 0301-4215. DOI: 10.1016/j.enpol.2010.05.053. URL: <http://www.sciencedirect.com/science/article/pii/S0301421510004246>.
- [18] Ensslen, A., Schücking, M., Jochem, P., Steffens, H., Fichtner, W., Wollersheim, O., Stella, K., "Empirical carbon dioxide emissions of electric vehicles in a French-German commuter fleet test." In: *Journal of Cleaner Production*. Cleaner production towards a sustainable transition 142 (2016), pp. 263–278. ISSN: 0959-6526. DOI: 10.1016/j.jclepro.2016.06.087. URL: <http://www.sciencedirect.com/science/article/pii/S0959652616307648>.

CONSUMER ACCEPTANCE OF V2G CHARGING

Abstract

This chapter aims to investigate the consumer acceptance of Vehicle-to-Grid (V2G) charging of electric vehicle (EV) drivers. The Theory of Planned Behaviour is extended based on literature to develop a conceptual model of the determinants of consumer acceptance of V2G charging. The research work comprises two stages of semi-structured interviews. In the first stage, 20 current EV drivers are briefed about V2G charging as a concept to validate and extend the conceptual model. A test set up with V2G charge point at a solar carport is then constructed at the Green Village, a living lab at the Delft University of Technology. 17 participants in the second stage are given access to a project-owned V2G-compatible Nissan LEAF and the constructed V2G charging facilities for at least a week each, after which they are interviewed. Clear communication regarding the battery impacts, financial compensation, real time monitoring and operational control are all found to foster acceptance. The main barriers for acceptance found are range anxiety in various forms, concerns about the effects of V2G charging on the EV battery and the restriction of the freedom offered by private vehicles. The participants are found to be divided across high, conditional acceptance and low acceptance of V2G charging. Our study suggests that there are EV users who are willing to use V2G charging in its current form and will continue to do so. The discussion provides insights on extending the relevance of our findings across other users groups and over further developments in the field.

This chapter is adapted from **Ghotge, R.**, Nijssen, K. P., Annema, J. A., Lukszo, Z., “Use before You Choose: What Do EV Drivers Think about V2G after Experiencing It?” In: *Energies* 15.13 (2022). Number: 13 Publisher: Multidisciplinary Digital Publishing Institute, p. 4907. issn: 1996-1073. doi: 10 . 3390 / en15134907, Heuveln, K., **Ghotge, R.**, Annema, J. A., Bergen, E., Wee, B., Pesch, U., “Factors influencing consumer acceptance of vehicle-to-grid by electric vehicle drivers in the Netherlands.” In: *Travel Behaviour and Society* 24 (2021), pp. 34–45. issn: 2214-367X. doi: 10 . 1016 / j . tbs . 2020 . 12 . 008, **Ghotge, R.**, Wijk, A., Lukszo, Z., “Challenges for the design of a Vehicle-to-Grid Living Lab.” In: *2019 IEEE PES Innovative Smart Grid Technologies Europe (ISGT-Europe)*. 2019 IEEE PES Innovative Smart Grid Technologies Europe (ISGT-Europe). Bucharest, Romania: IEEE, 2019, pp. 1–5. isbn: 978-1-5386-8218-0. doi: 10.1109/ISGTEurope.2019.8905503

7.1 INTRODUCTION

When first proposed by Kempton and Letendre [1], the V2G concept envisioned a higher level of utilisation of the storage capacities of EVs in the electricity grid. The distributed fleet of parked and plugged in EVs, if V2G compatible, would be able to provide services to the grid in exchange for which EV drivers would be financially compensated. The services provided by this storage would enable the integration of higher shares of variable renewable powerplants, reduce the need for expensive peaker plants and lower the total cost of ownership of EVs [2]. It would also enable the better utilisation of the scarce capacity in the electricity grid.

Today, V2G technology is more mature and close to being commercial. Some commercially available EVs [3] as well as charge points [4–6] are now V2G compatible¹. European grid operators are creating market-based mechanisms to enable the integration of demand-response capable EV fleets in the European grid [7, 8]. Legislative obstacles to V2G application at the European level, such as the double taxation² of storage, have been removed [9]. Standards enabling universal and interoperable communication between EVs and charge points are, at the time of writing, close to publication. Wider acceptance amongst consumers remains a necessary prerequisite for further adoption and commercialisation of V2G technology [10].

The consumer acceptance of V2G charging remains understudied, with research focusing on the more technical aspects of the concept. Integration of renewables and storage, grid services and the consequences of V2G cycling on battery degradation form a majority of the research. In a comprehensive review of 197 articles, Sovacool et al. [11] found consumer acceptance and the social aspects of V2G to be addressed in less than 3% of available peer-reviewed literature. Similarly, Park Lee [12] found a lack of studies on the socio-technical barriers in the available literature on V2G. Gschwendtner et al. [13] conducted 47 interviews with industrial and academic V2G experts, based on which the *actual interest of EV users* was found to be a key knowledge gap. Since the successful implementation of V2G charging at scale needs the engagement and acceptance of the EV driver, there is a need for further insights on the consumer acceptance of V2G charging.

As we show in the literature review in section 7.2, no earlier studies on the consumer acceptance of V2G have involved participants who have actually experienced V2G charging. We aim to address this gap in literature by being the first study to investigate the consumer acceptance of V2G charging among participants who have actually experienced V2G and used it as part of their daily routine.

1 For further information on V2G charge points, refer Chapter 2, section 2.2.4

2 Double taxation refers to taxation on both charged as well as discharged energy units with respect to grid-connected energy storage assets.

This chapter is structured as follows: Section 7.2 describes the scientific literature used to structure the interview protocol. Section 7.3, describes the interview methodology used and the design of the V2G trials. Section 7.4 provides an overview of the interview results before and after the users' experience of the trial. Finally, section 7.5 presents the conclusions of this work.

7.2 LITERATURE REVIEW AND CONCEPTUAL MODEL

Consumer acceptance, as defined by Huijts et al. [14], is '*the public's behavioural responses to the availability of technological innovations which leads to the purchase and use of such products*'. We modify this definition to apply it to V2G charging as '*the public's behavioural responses to the availability of V2G charging which leads to the purchase and use of V2G-related products and services*'.

Based on this definition, we review several works in scientific and non-scientific literature that discuss consumer acceptance of V2G charging. We also include studies covering unidirectional smart charging, because although unidirectional smart charging is distinct from V2G, there remain several common themes in terms of consumer acceptance.

Early studies on V2G acceptance with vehicle drivers were, as a result of low EV adoption at the time, almost entirely conducted with the drivers of Internal Combustion Engine (ICE) vehicles, who were seen as prospective EV users. Based on an online survey among 3029 respondents at various locations in the US in 2009, Parsons et al. [15] concluded that respondents preferred upfront discounts on EVs or pay-as-you-go contracts, as opposed to contracts that limited the freedom of drivers to charge as they wished.

Geske and Schumann [16] conducted a survey with 611 respondents in Germany in 2013, and were among the first to consider participants who had driven EVs: their sample included 14 EV drivers, at a time when only a few hundred private EVs were registered in Germany. Based on discrete choice experiments, they found 'range anxiety' and 'minimum range' to be important determinants of the respondents' willingness to participate in V2G.

Noel et al. [17] conducted an online survey in 2016 and 2017 in the five Nordic European countries to investigate the willingness to pay for the EV attributes of range, acceleration, recharging time, source of electricity and V2G capability. The 4105 final respondents surveyed included an unspecified number of drivers with experience of driving an EV. The study found diverging attitudes on the willingness to pay for V2G capability in EVs: customers were willing to pay more for vehicles with V2G compatibility in Norway and Finland, while they were not in Sweden, Iceland and Denmark.

In these early studies, due to the lack of EV drivers within the respondent samples, there appeared to be a clear lack of knowledge about EVs in general and V2G in particular among the survey participants. This knowledge gap led to both a communication barrier between the researchers and the participants, as well as uncertainty about the predictive validity of the conclusions for future drivers who actually drove EVs. Parsons et al. [15] described the respondents' comprehension as a barrier, requiring simplification of the survey. The respondents (details provided in [18]), having low knowledge about EVs, were presented with information on EVs as electric versions of gasoline vehicles. A large fraction of respondents in these studies had never heard about V2G before taking the survey or knew very little about V2G³.

Besides the lack of EV knowledge among participants, the method of study - surveying - also limited the depth of the insights that could be obtained. The dominant approach used by researchers to overcome this limitation of surveying was by conducting expert interviews.

Kester et al. [19] conducted 221 semi-structured interviews with 257 participants from 201 institutions in the Nordics. The interviewees included an array of stakeholders from the fields of transport and electricity, including national and local government, regulatory authorities, academia, electricity companies, automobile manufacturers and other industrial groups. These interviewees provided detailed insights into double taxation on energy storage and similar legislative barriers, restructuring the market based on the dynamic pricing of electricity, reworking of network tariffs to reflect realtime congestion in the grid and support for pilot projects and information sharing.

Based on the same large set of interviews, Noel et al. [20] analysed the main reasons for experts' skepticism on the outlook for V2G while Sovacool et al. [21] described the broader visions of experts describing EVs and V2G. Interestingly, consumer acceptance or rather lack of it, was cited by 17% of the interviewees as a reason for expert skepticism, with other major reasons included a preference for alternative technologies, battery degradation, poor business cases, the high complexity of systems, the low number of EVs in use and unsuitable market structures [20]. The broader visions of experts were also found to be highly divergent, with little consensus among either selectors or enactors of future developments in the field [21].

Sovacool et al. [11] found consumer acceptance and the social aspects of V2G to be highly understudied in a broad literature study covering 197 peer-reviewed articles. Park Lee [12] found a lack of studies on the socio-technical barriers in the available literature on V2G. Gschwendtner et al. [13] conducted 47 interviews with industrial and academic V2G experts, based on which the *actual interest of EV users* was found to be a key knowledge gap. These studies suggest that the lack of customer acceptance cited as a reason for expert

³ 90% of those surveyed by Noel et al. [17] had never heard of V2G. 87.7% of those surveyed by Geske and Schumann [16] had never heard of V2G, 11.3% had heard of it, but knew little to nothing about it, while only 1% stated that they knew quite a bit or a lot about V2G.

skepticism [20] stems from uncertainty about customer opinions among experts rather than being based on evidence.

With increased adoption of EVs, several recent studies have focused on collecting data from only EV drivers to obtain a more informed opinions from participants.

Zonneveld [22] built upon work on V2G contracts conducted by Park Lee [12]. A choice experiment was conducted via an online survey and found that remuneration, guaranteed energy, contract duration, discharging cycles and plug-in duration were the most important elements (in decreasing order of importance) in V2G contracts among Dutch EV drivers. Also taking advantage of the relatively high EV penetration rate in the Netherlands, Meijssen [23] used online and offline surveys to contact Dutch EV drivers. The availability of fast charging facilities was found to reduce EV users' concern for minimum battery state of charge, and consequently made them more willing to participate in V2G contracts.

In Project Scurius, the world's largest V2G trial to date, over 320 V2G units were installed at homes in the UK [24]. 140 participants were surveyed after using these V2G charge points with their Nissan LEAFs. The use of V2G technology was found to alleviate participants concerns regarding V2G performance. However, the underlying motivations influencing broader customer acceptance of the technology, which are difficult to investigate through surveying techniques, remain unaddressed.

Several studies also investigated the consumer acceptance of unidirectional smart charging. As the technology is further developed, interviews with consumers in demonstration projects have more commonly been conducted. Among the earlier studies, the ELVIIS (Electric Vehicle Intelligent InfraStructure) project, conducted in Göteborg, Sweden, included 16 interviews with EV drivers who used the smart charging system developed over the course of the project. The results revealed that the interviewees were largely satisfied, but found the experience slightly stressful, though the experience seemed linked more to the specific interface used than the concept [25].

Similarly, Schmalfuß et al. [26] interviewed 10 EV users after they had used a smart charging system for EVs as part of a project in Germany. The control of charging was accepted by most interviewees, though a few had problems with the knowledge and skills required to use the interface. Also in Germany, Will and Schuller [27] used surveys to collect data from EV users in order to understand the factors influencing users' acceptance of smart charging (unidirectional). Again, the results show high levels of acceptance of the concept, with the strongest motivations being contribution to grid stability and integration of renewable energy, rather than monetary compensation. Delmonte et al. [28] conducted interviews with both EV users and IC engine users in the UK, and reported that twice as many users opted for management of charging themselves as the number that opted for automated charge scheduling.

A large fraction of existing literature on consumer acceptance of V2G charging includes the use of ICE users rather than EV users. And none of the detailed acceptance-focused studies included participants who actually experienced V2G charging.

This lack of experience-based insights is a significant shortcoming in the existing literature. Experience with technology is known to increase knowledge among users of the technology [14]. This increased knowledge, together with the actual experience of a trial, both influence the perception of the costs and benefits of the technology by these users. Several examples in the field of electromobility reveal the importance of trial experience to consumer acceptance.

Schneider et al. [29] found that the experience of driving an EV was linked with observability and trialability, both of which led to increased consumer acceptance of EVs. Jensen et al. [30] found that EV users' preferences changed after they experienced driving an EV, particularly with respect to driving range and top speed. The 3-month period over which each participant used an EV was also found to have an influence on their willingness to pay. Franke and Krems [31] and Bunce et al. [32] both found that greater experience with driving EVs increased their confidence with vehicle range and changed the frequency of charging. Shaheen et al. [33] tested users' perceptions of Fuel Cell Electric Vehicles (FCEVs) based on a longitudinal study conducted in California and Michigan. After trial participants were given the opportunity to use the vehicles, their perceptions of the safety of the fuel and the vehicle improved.

We aim to fill the identified gap in existing literature through an investigation of EV users attitudes to V2G charging based on experience. The question we ask is: "What are the most important factors influencing the consumer acceptance of V2G charging based on their experience of it?"

To the knowledge of the authors, this is the first study to investigate the consumer acceptance of V2G charging based on actual experience.

The research was conducted in several stages. Initially, literature on what constitutes acceptance of technology in general and V2G charging in particular was reviewed. We extended the Theory of Planned Behaviour (TPB) to build a conceptual model of factors influencing the acceptance of V2G charging. Semi-structured interviews with 20 EV drivers were conducted to validate and expand the model. A trial was then conducted during which participants experienced the use of a V2G compatible EV with V2G charging at the workplace. Finally, additional interviews were conducted to gauge their consumer acceptance of V2G charging after their experience of the technology.

7.2.1 THEORY OF PLANNED BEHAVIOUR AND CONCEPTUAL MODEL

We adopt the TPB as a basic structure for a conceptual model. The TPB states that actual behaviour is determined by the behavioural intention, for which there are three independent determinants: the attitude, the subjective norm and the perceived control [34]. However, we use an extended form of the TPB, as presented in [14], where it is modified for use in technology acceptance studies.

When applied for the evaluation of technology acceptance, the *attitude towards the technology* describes the degree to which a person has a favourable or unfavourable evaluation of the technology in question. The *subjective norm* refers to the perceived social pressure to use or not use the technology and the *perceived behavioural control* reflects the perceived degree of ease or difficulty associated with using the technology, reflecting both past experience as well as anticipated obstacles with its use.

We use this model for several reasons. Firstly, the model is well suited for application to technology acceptance. Several other models, such as the Technology Acceptance Model (TAM) and the Unified Theory of Acceptance and Use of Technology (UTAUT) draw from the TPB and the Theory of Reasoned Action (TRA), on which it is based. Secondly, it is versatile and sufficiently broad in its scope to be suited to a specific technology - in our case, V2G charging. Among alternatives, the parsimonious TAM model, derived from acceptance of information technology, with only two predictors is expected to overlook some of the complexity involved in V2G charging. Earlier works suggest consumer acceptance of V2G is likely to be closely linked with attitudes towards the environment and energy transition [16, 35], which are not covered by the two TAM determinants: ease of use and perceived ease of use. In contrast, the highly comprehensive UTAUT is challenging to operationalise for a specific technology due to its complexity. Finally, the TPB, as extended by Huijts et al. [14], explicitly includes the influence of “experience of the technology”, which is the main focus of this work.

Fig. 7.1 shows the conceptual model used in this study. The TPB was extended based on literature to study the consumer acceptance of V2G, which is shown in grey.

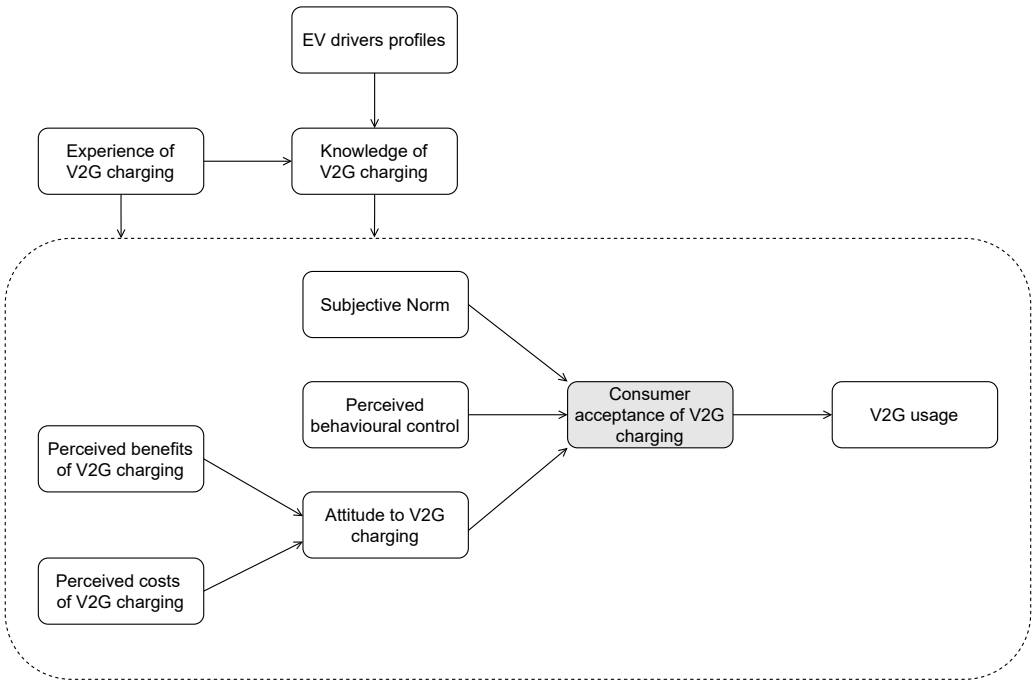

Figure 7.1: Conceptual model describing the influence of factors on consumer acceptance of V2G (modified based on Huijts et al. [14])

In accordance with the original TPB, we expect three independent determinants of the consumer acceptance of V2G: the subjective norm, the perceived behavioural control and the attitude towards V2G. The attitudes to V2G charging are expected to be shaped by the benefits and costs associated with the use of V2G charging, as perceived by the user.

Experience of V2G charging of the users as well as their *knowledge of V2G charging* prior to the collection of data are expected to shape all these determinants. Experience also has the direct effect of increasing knowledge, which we are particularly interested in in this study. The EV users profiles including age, occupation, level of education and familiarity with EVs are expected to lead directly to knowledge, indirectly influencing the perceived benefits, risks, subjective norms and perceived behavioural control. Since none of our participants have used V2G charging earlier, there is no link between the profiles and experience.

We distinguish *consumer acceptance* from *V2G usage*, shown on the extreme right. We define V2G usage as V2G charging in a more commercial setting, thus including financial transactions, contractual agreements and even choice for consumers among alternative products delivering the same value⁴. Since our study was conducted as part of a research pilot, we were unable to test the users responses in a more commercial

⁴ This definition also distinguishes V2G usage from the *experience of V2G charging*, shown on the top left

environment. However, we expect the consumer acceptance of V2G charging to be a strong predictor of future V2G usage.

7.3 METHODS

Acceptance and adoption research in the field of V2G charging is at an early stage, and has attracted a relatively small amount of attention in V2G projects and trials conducted so far⁵. Qualitative methods were therefore applied to enable exploratory research.

The research work comprised two cross-sectional studies:

- Stage 1: Interviews without experience (\mathbf{I}_{NoEx})
- Stage 2: Interviews with experience (\mathbf{I}_{Ex})

As part of \mathbf{I}_{NoEx} , semi-structured interviews were conducted on a sample of EV users who had never used a V2G charge point. The purpose was to validate the conceptual model, as well as to identify the factors that EV users found most important for their acceptance of V2G charging. Later, as part of \mathbf{I}_{Ex} , a different sample of EV users were given the opportunity to use a V2G compatible Nissan LEAF belonging to the project and charge it at a V2G charge point. They were then interviewed to obtain insights into their consumer acceptance of V2G charging after their real-life experience of it.

7.3.1 SAMPLING OF PARTICIPANTS

The broader population considered in this study was the population of EV users in the Netherlands⁶. Only EV users were considered, since the knowledge, awareness and familiarity of non-EV users with EV driving, charging infrastructure, charging routines and range management were expected to be inadequate for them to meaningfully contribute to a discussion on V2G in \mathbf{I}_{NoEx} . Further, the learning process required of them to participate in \mathbf{I}_{Ex} was expected to take too long to accommodate them within the project timeline.

The call for participants in the research project was advertised on a Dutch social medial channel: ‘Association of Electric Drivers’, on screens and posters on the campus of the Delft University of Technology and by approaching individuals in the researchers’ professional networks. For \mathbf{I}_{Ex} , the advertisement mentioned that participants would get to use an EV, which was later found to be an attractive incentive for participation.

20 participants were interviewed as part of \mathbf{I}_{NoEx} while 17 different participants took part in the trial and were subsequently interviewed as part of \mathbf{I}_{Ex} . Although it is possible

⁵ Refer Sovacool et al. [10], Edwards and Landi [36], and *V2G Around the world* [37] for a comprehensive overview of V2G research and projects.

⁶ Including both BEV as well as PHEV users, but not including FCEV users.

that the 20 participants chosen in I_{NoEx} and the 17 participants chosen in I_{Ex} would respond differently based on (for example) slightly younger age distribution or other profile characteristics, we found no evidence to support or invalidate this. However, this does not fulfill the requirements of a longitudinal study, where the same participants would participate in both stages, to completely eliminate the differences in profile between the two samples.

7.3.2 PROFILES OF THE SAMPLE POPULATION AND REPRESENTATIVENESS

Data on the age, gender, highest educational qualification, income level and information regarding their previous knowledge and familiarity with EVs was collected as part of both I_{NoEx} and I_{Ex} . Some of these are presented in Fig. 7.2.

In both I_{NoEx} and I_{Ex} , most participants are between 25 and 55, a majority is male and university-educated. Although several participants, being students, were not working as yet⁷, those who were typically had an annual income of over €35,000.

The sample sizes considered are extremely small relative to the target population of Dutch EV drivers. Further, to the best of the author's knowledge, there is no existing comprehensive record of Dutch EV drivers, with which to compare the sample interviewed in this study. However, there are similarities between the samples obtained here and earlier studies.

In 2017, Hoekstra and Refa [35] found that a majority of Dutch EV drivers were middle-aged males with high education, well paying jobs and enthusiasm for technology. More recently, survey-based studies on V2G conducted by Zonneveld [22] in 2018 and Huang et al. [38] in 2019 in the Netherlands also reveal a majority of male, wealthy and well-educated participants. Internationally, with larger surveys of several thousands conducted to identify early adopters of EVs, Plötz et al. [39] in Germany and Sovacool et al. [40] in the Nordics both found EV users tend to be male, middle aged and well educated.

⁷ or were working part-time while studying with correspondingly lower incomes

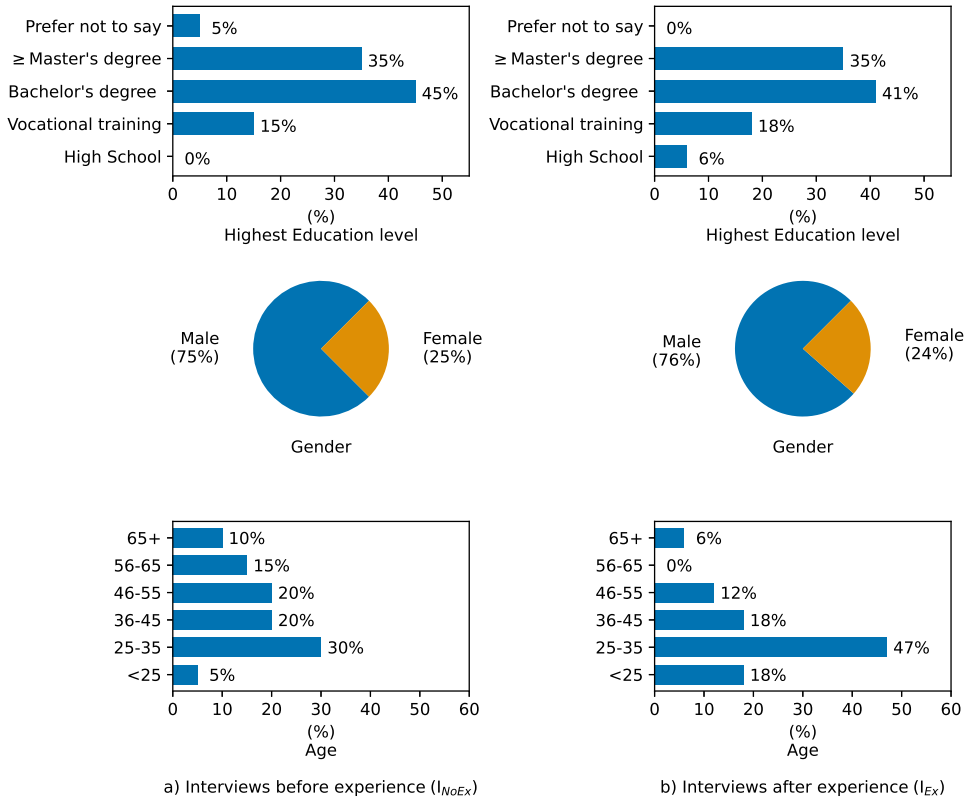

Figure 7.2: Socio-demographic characteristics of the interviewees without V2G charging experience (I_{NoEx}) and with charging experience (I_{Ex})

On the other hand, statistics on total Dutch car ownership show that females, elderly drivers (>65 years old), persons with a lower educational qualifications and households with lower incomes form a larger fraction than those in our sample [41, 42]. We interpret this to indicate that the EV driving population is itself not representative of the wider vehicle driving population. Although we cannot establish the representativeness of our sample with respect to the target population of Dutch EV drivers, we hope to identify more generalisable insights into their consumer acceptance.

7.3.3 SEMI-STRUCTURED INTERVIEWS

Before I_{NoEx} , participants were given a short presentation describing how V2G charging worked as a concept at various locations. The interview protocol was constructed based on the theoretical model. The interviews themselves were semi-structured: the interviewees were asked a common set of broad questions, within which they were

allowed to determine the salience of individual themes and the depth of various discussion points. Each interview lasted for about an hour and was conducted in Dutch, with transcripts later translated to English. Though conducted with a different sample, the methods used for interviews in I_{Ex} were identical⁸. However, participants in I_{Ex} received far more information during the intake, as described below.

7.3.4 PARTICIPANTS' EXPERIENCE WITH V2G CHARGING

The participants in I_{Ex} were each given the use of a V2G-compatible 30 kWh Nissan LEAF for the duration of at least a week. They received access to a V2G charge point located at the Green Village, a living lab in the Delft University of Technology. At the Green Village, a 2-car solar carport was constructed, with two EV charge points. One was a 7.4 kW Alfen AC charge point, while the other was a 10 kW EVTEC DC charge point.

The DC charge point was V2G compatible on the CHAdeMO protocol and was programmed to increase the self-consumption of the solar energy generated in the solar carport system and shave peaks in demand beyond a set power threshold value. The increased use of solar energy produced at the carport, combined with the reduction in peak demand, enabled two vehicles to charge at the carport whose power capacity at the grid connection was only sufficient for the charging of a single vehicle. The test set-up is shown in Fig. 7.3 and an example of the operation of the system over a day is provided in Appendix 7.6.

At the intake, the participants in I_{Ex} were each given a tour of the test setup and given an explanation of how the system worked. They were given a short test drive in the LEAF and the chance to connect and disconnect the CHAdeMO charging plug. Their interaction with the V2G charging system in terms of physical interaction or data exchange was only at the points of plug-in and plug-out via the basic interface on the charge point itself. The interface on the charge point communicated only the instantaneous charging power, the battery SoC and the estimated time remaining to complete charging. No app or other human-computer interface was provided for additional insight about electricity use, charging power or other details remotely.

⁸ Due to regulations associated with the COVID-19 pandemic of 2020-21, all the interviews conducted in I_{Ex} took place online



Figure 7.3: V2G test set-up at the solar carport located at the Green Village, TU Delft (Image courtesy of The Green Village)

Since the participants all worked or studied close to the Green Village, they were asked to treat the setup as a workplace charging facility. The participants were given an informed consent form, which permitted the collection and use of their data in the study.

All participants had access to the LEAF and charge point for at least a working week. A typical routine expected was a commute to the University by EV and plug in each morning, leaving it for the duration of the working day and plugging out before going home in the evening. Several participants used the vehicle for trips other than commuting,

such as attending meetings, running errands and going for trips on the weekends, when it was available to them. They were requested to avoid charging at other locations as far as possible, but were given access to a charge pass in case charging at other locations was essential. No financial incentives were offered during the trial, either for participation or for V2G charging, nor were any contractual agreements made beyond the informed consent form.

After the participants completed their respective driving weeks, they were interviewed as described earlier. The 17 interviews of participants with experience of V2G charging formed the second stage of the study, I_{Ex} .

7.3.5 CODING AND DATA ANALYSIS

The interview transcripts were analysed to identify important themes recurring across the various interviews. These themes were categorised into codes describing them. The conceptual model was used as a lens to group the codes into an initial codebook. This initial codebook was then expanded iteratively to find newly emerging codes and code groups.

During the first two interviews conducted as part of I_{NoEx} , 43% of the 81 I_{NoEx} codes were found, as seen in Fig. 7.4. The figure shows that we approach code saturation after a relatively small number of interviews. Relatively few codes were identified after the first seven interviews. The thirteen interviews conducted afterwards helped validate the initial findings.

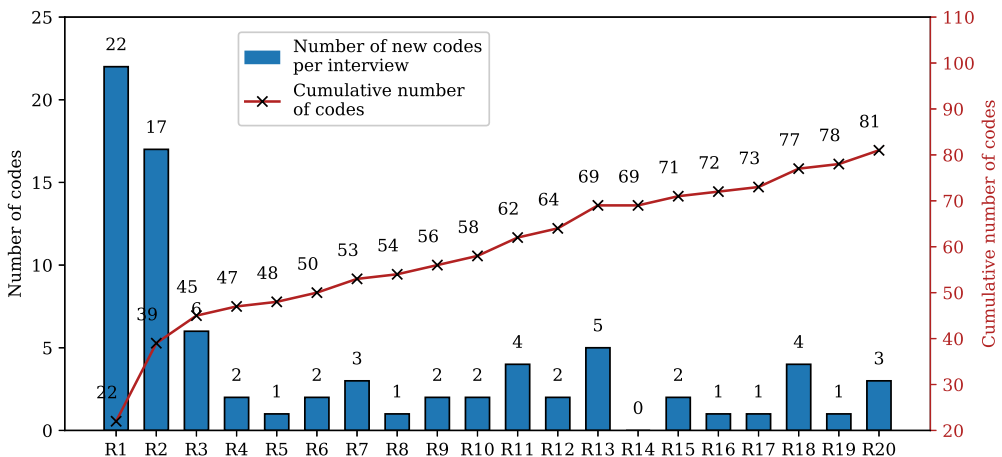

Figure 7.4: Code saturation observed over interviews

7.4 RESULTS AND DISCUSSIONS

The results of the interviews are described below, showing the factors important for user acceptance of V2G charging and differences found between the two stages, I_{NoEx} and I_{Ex} , as a result of experience of the system.

7.4.1 FACTORS INFLUENCING CONSUMER ACCEPTANCE OF V2G CHARGING

The ten most mentioned codes found during I_{NoEx} , are presented in Table 7.1, with a short description. They are ordered by *groundedness*: the number of quotations from the I_{NoEx} transcripts assigned to each code.

Table 7.1: Top codes mentioned by interviewees ordered by groundedness

No.	Code	Number of interviewees mentioning this code	Groundedness
1	Compensation	17	33
2	Battery degradation	18	25
3	Range anxiety	16	23
4	User interface	12	23
5	Location	18	22
6	Communication	8	15
7	Control of charging parameters	13	14
8	Societal contribution	9	13
9	Lack of standards/ protocols	6	11
10	User-friendliness	10	10

Compensation was found to be the most commonly mentioned factor. Several participants indicated that compensation for V2G charging would be welcome, though one interviewee, $I_{NoEx}13$ was skeptical about whether V2G would ever earn enough to cover the cost of degradation of his battery. Compensation in kind, such as cheaper energy or free parking was also seen as acceptable.

Several participants expressed concern about *battery degradation*, describing it as a significant barrier. They were interested in whether the degree of degradation exceeded

that caused by regular driving, how it would affect the battery lifetime and how much compensation would be considered adequate. Interestingly, participants using leased EVs were less worried about battery degradation. As I_{NoEx}6 put it, “...battery degradation may be noticed after 3-4 years, but then I can get a new car from the lease company.”

Many participants were worried about *range anxiety*, and expressed a lot of interest in a *user friendly interface* whereby they could see the state of charge of the battery or the remaining range through an app or on the charge point itself. This was closely linked with *control*, where several participants liked the idea of being able to opt out of V2G events. On the other hand, although there was a lot of interest in seeing the various parameters, there were also some participants not in favour of control, who just wanted some insight into the system. In the words of I_{NoEx}13,

“Preferably, I do not want real-time control. For instance, I don’t want to get notifications throughout the whole day about V2G... I believe that a weekly or monthly report (on display in the car or on my smartphone) are enough for me.”

Most participants in I_{NoEx} envisioned V2G charging to take place in the *locations* where they currently charged their EVs: at home and at the workplace. Aside from compensation, the idea that V2G charging was somehow helping *solve societal problems* like carbon emissions or overloaded grids were found attractive by participants. They found the framing of this *communication* to be an important reason for them to participate.

Finally, several participants reported being unaware of *charging protocols*, while other were aware of the lack of a single DC charging protocol.

7.4.2 NEW KNOWLEDGE AS A RESULT OF EXPERIENCING V2G CHARGING

Initial analysis of the I_{Ex} interview transcripts revealed that the knowledge levels of many participants increased considerably as a result of the trials. There were also several ways in which this knowledge increased. Firstly, several participants were unaware that V2G charging existed as a concept, having heard about it for the first time when they heard about this project. Secondly, even though some had heard of it, they admitted that their *understanding* of the way it worked increased, particularly with regard to the operational aspects of it.

As an example, I_{Ex}9, who was familiar with the V2G concept, said that she associated the idea of V2G with the greater efficiency of resources, putting idle batteries to use. However, her experience of V2G charging made her “*view of the technology less theoretical and more realistic*”, because she “*became familiar with the costs that using idle battery capacity brings.*” Similarly, I_{Ex}3, who had also heard of V2G before, said

that he “*became aware of the difference between theoretical possibilities and practical realities*”.

Thirdly, a number of participants revealed that they obtained a better idea of both the benefits as well as the drawbacks of V2G charging as a result of using the V2G charge point. Usage of the system provided them with both a clearer vision of the potential of the technology, while also helping them understand the aspects of it that they disliked or would like improved. When I_{Ex} 16 was asked if the way she described the project to friends had changed after the trial, she mentioned that before the trial, she “*had no knowledge of V2G’s existence so never spoke to others about it*”. However, after the trial, she described it “*in a neutral manner ... providing the pros and cons*”.

These benefits and risks realised by various participants over I_{Ex} ranged from finding out that V2G charging could earn them financial compensation, worries about fire safety and fire safety standards, ideas about electricity trading and increased awareness about their electricity consumption.

It is also interesting to note that several participants explicitly mentioned that the trial did not affect their views. However, this would often be contradicted later in the interview. For instance, I_{Ex} 17 mentioned that the trial did not change his perception of the technology at all, only serving to “*reaffirm ... [his] beliefs*”. However, he then went on to describe how the impact of V2G charging on battery lifetime and battery capacity should be compensated for differently, an idea that he thought of during the trial period.

Similarly, I_{Ex} 16 mentioned that the experience of V2G charging did not affect her perception of the technology. However, when asked about the possibilities of use in a commercial setting, she mentioned that she was now aware of which barriers to look for before making a purchase decision. It seems likely that these participants underestimated the extent to which the trial experience influenced their views.

7.4.3 EFFECTS OF EXPERIENCE ON THE IDENTIFIED FACTORS

The results obtained from I_{Ex} revealed some differences with those obtained from I_{NoEx} . Although the factors described in Table 7.1 formed the broad basis of the discussions after experience, the discussion about factors lined with the participants experience, like *range anxiety* and *user interface* were brought up far more often than the more abstract *lack of standards/protocols*.

Compensation remained an important factor. However, in I_{NoEx} , compensation was generally framed as remuneration for battery degradation caused or electricity discharged from the battery. While compensation for battery degradation was still expected to be provided, during I_{Ex} , many users framed compensation as an exchange for the additional uncertainty in range or SoC that they faced. As I_{Ex} 12, clearly stated, “*Compensation should be clearly defined, and should not only cover the financial costs of*

battery degradation but also the uncertainty of not knowing your state of charge [at departure].”

Most participants mentioned that compensation was a pre-requisite for future adoption, and several expressed a preference for a clear estimation to be provided to the vehicle user. Most expected this estimate to be provided at the time of purchase of the vehicle, while some discussed lower costs of energy at home or at work, smart contracts or parking privileges. Leasing of vehicles was brought up several times and the inclusion of compensation within the leasing contract was seen as a convenient option.

Range anxiety was described by participants very often, and seemed more of a concern than battery degradation. There were also several different concerns, each of which is associated with range, which may be categorised into three individual phenomena.

Uncertainty about real time vehicle state-of-charge: No interface was provided to check the SoC of the battery remotely - it could only be checked from within the vehicle or by looking at the charge point. This led to stress. $I_{Ex}9$ reported that on days when she needed range urgently, she went to the vehicle during the working day, just to see if it was charging. Similarly, $I_{Ex}16$ stated that when buying an EV, she would only opt for enabling V2G if there was a way to view the current state of charge since she found it important to always have sufficient range available.

Planning fatigue: Trial participants reported anxiety caused by the need to continuously plan charging in order to have sufficient range for future trips. $I_{Ex}12$ mentioned the stress that he felt by the need to continuously plan his trips without knowing the SoC of the vehicle. When asked in the interview about what he remembered most about the trial, $I_{Ex}12$ mentioned the “*constant consideration about the next charging cycle, especially on longer trips*”.

Anxiety about reaching the destination: Most participants described what may be termed as *classic range anxiety* - the fear of not having sufficient range to reach their planned destinations and the anxiety associated with this. Several also came up with their own techniques to deal with this: $I_{Ex}3$ used an app provided by the researchers to obtain a more accurate estimate of range than the estimate provided by the LEAF itself. $I_{Ex}17$ reported spending significant time before a long trip looking up public charging locations beforehand in case they were needed.

Curiously, a single participant, $I_{Ex}11$, reported that after participating, his doubts about uncertain range reduced. However, most of the others described range anxiety in one form or the other. As mentioned earlier, compensation for the additional anxiety caused by V2G emerged beyond the insights from I_{NoEx} .

Battery degradation, though less important than in I_{NoEx} , remained an important point of discussion. Several participant wished to have a clearer idea of how much battery degradation was caused through V2G cycles, preferably in terms of both reduced

energy storage capacity as well as in terms of reduced battery lifetime. These losses were typically expected to be compensated for. Battery degradation as a result of V2G cycles was, thus, not seen as a deal-breaker. Several participants expressed that they would like to know the impacts at the time of purchase of the vehicle: ideally that was when it would be compensated for as well. However, a few mentioned smart contracts or compensation during/based on use.

Vehicle leasing was often brought up in relation with battery degradation, as during I_{NoEx} , with a leasing model seen to make battery degradation less worrisome than vehicle ownership. The battery-leasing model, as available for the Renault ZOE in Europe, was mentioned multiple times as a “solution” for battery degradation.

The *user interface* was discussed extensively, together with the *control* of the V2G system in operation and the *user-friendliness* of the system. As discussed earlier, the lack of an interface to remotely check the state of charge and other charging and battery parameters was noted by most participants. A majority of participants mentioned that they would like to be able to give inputs to the system. The different types of inputs mentioned by participants included

1. a specific power level
2. minimal range at departure
3. minimum state of charge
4. minimum state of charge at departure
5. informing the system that the vehicle would not be needed for several days
6. a V2G opt-out option.

Many said that their use of such a system in the future was conditional on the availability of either or both of two features: insight on SoC and some form of control. The most preferred interface recommended was through a smartphone app though I_{Ex11} mentioned a smart watch.

Several participants mentioned that the system was easy to use. Since it was a plug-and-charge system, there was no need for the charging pass, which is needed for accessing public charging in the Netherlands. This was also appreciated by several participants. I_{Ex1} said that “*the V2G charging station was easy to use and should be for others as well*”. Similarly, I_{Ex2} believed that most users should be able to use V2G charging, since she had “*learned effortlessly*”.

Another difference between I_{NoEx} and I_{Ex} was that *location* was discussed less. A few participants described how they envisioned such a system being installed at their homes, or being applied to deliver power at camping locations, but most of the conversations were about the workplace charging system that they had used during the trial.

However, more attention was paid to the participants' *routines*, and how they perceived V2G charging to fit into them. $I_{EX}4$ said that V2G charging at the workplace would fit his lifestyle since he usually worked from 9 to 5, while $I_{EX}5$ reported that he “*always connected the car in the morning and left in the late afternoon*”. Interestingly, $I_{EX}9$, who drives an ICE, mentioned that she disliked filling up her tank “*as it always comes at an inconvenient moment*” and that being connected to a charge point was more convenient since the battery was always “*filled up*”.

On the other hand, several participants felt that V2G charging conflicted with the *personal freedom offered by a private car*. $I_{EX}10$ mentioned that while the technology might be “*beneficial to society as a whole*”, he still valued the freedom that a personal vehicle should provide. Similarly, $I_{EX}17$ mentioned that the uncertainty associated with the use of the system “*limits the freedom of the personal car*”.

In I_{EX} , several participants mentioned that the main reason for joining the study was so that they could receive access to an EV for a week. However, their motivations for using V2G charging in the future were found to vary. While compensation played an important role, the *societal contributions* found in I_{NoEX} were still found to be an important factor. Many participants reported that they liked the pilot set-up, which ensured that vehicles were charged with solar energy. They also seemed to appreciate the fact that their charging could help tackle issues in the electricity grid, contribute to the energy transition and enable the efficient use of resources at a societal level. It is also interesting to note that V2G charging (including financial compensation for it) was seen as cooperative, social and environmentally responsible charging behaviour as compared to immediate charging, rather than profit-oriented behaviour.

7.4.4 CONSUMER ACCEPTANCE OF V2G CHARGING

Based on the analysis of the two stages of interviews, I_{NoEX} and I_{EX} , a final model of the determinants of V2G charging was developed, shown in Fig. 7.5.

The structure of the model, as presented earlier, in Fig. 7.1, remains unchanged. As anticipated in the conceptual model, experience of V2G charging did result in an increase in knowledge among the participants. Additionally, both experience and knowledge were found to affect the subjective norms, the perceived behavioural control and the perception of costs and benefits based on which the attitude to V2G charging was developed. Examples of factors from the interviews found in each of these categories are shown in Fig. 7.5, to demonstrate the validity of the model.

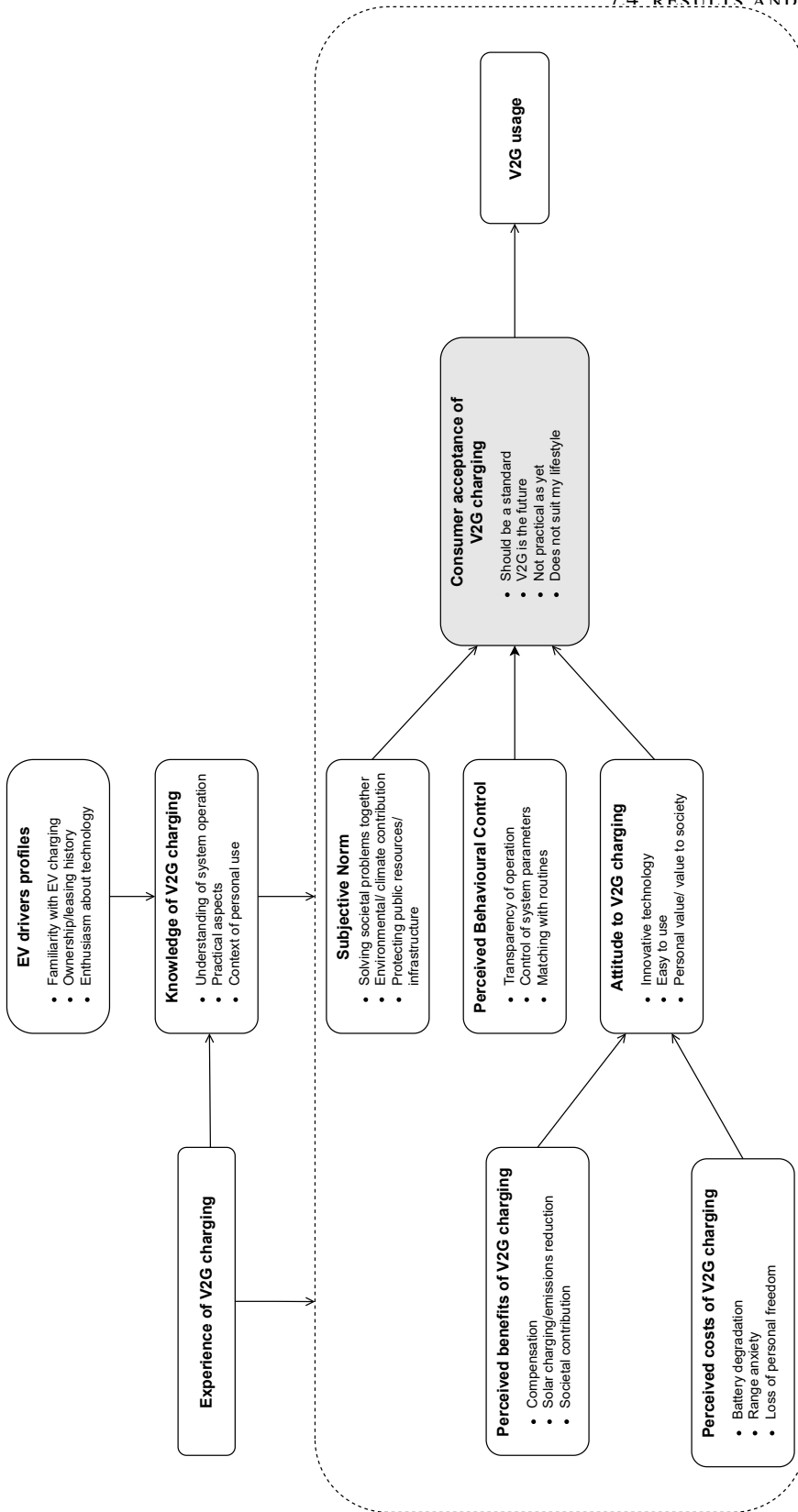

Figure 7.5: Final model describing the influence of factors on consumer acceptance of V2G

The quantitative estimation of the consumer acceptance of V2G charging is not the goal of this study. As such, the participants were not presented with a Likert-scale or traffic light rating system to fill in their opinions. However, the interview transcripts enable a qualitative interpretation of the degree of acceptance among the participants. These are shown in Table 7.2. We show only the results from \mathbf{I}_{Ex} due to their enhanced validity as compared with \mathbf{I}_{NoEx} .

Relevant quotations from the interview transcripts were categorised into three degrees of consumer acceptance:

1. *High consumer acceptance*, indicating an enthusiasm for V2G charging as experienced in this study
2. *Conditional consumer acceptance*, indicating future V2G charging in case certain criteria are satisfied and
3. *Low consumer acceptance*, indicating disinterest in the future use of V2G charging

Table 7.2 shows that among the 17 participants in \mathbf{I}_{Ex} , 4 showed low consumer acceptance, 6 showed high consumer acceptance while 7 showed conditional consumer acceptance. The main factors cited by \mathbf{I}_{Ex} participants for non-acceptance were the loss of freedom, increased uncertainty associated with charging and the impracticality of integrating V2G charging in their daily lives. The participants showing high acceptance typically cited the enhanced functionality of V2G charging and expected it to be a part of the future, either implemented as a standard or normalised in terms of public use. The remaining \mathbf{I}_{Ex} participants said that they would use V2G charging in case certain conditions were satisfied. While the most commonly stated conditions were related to enhanced transparency and control via the user interface, other reasons were linked with home (and parking lot) ownership, compensation and the scale of EV use among the public.

Table 7.2: Qualitative interpretation of consumer acceptance of V2G charging in I_{Ex}

I_{Ex} No.	Quotations from transcripts		Degree of Acceptance
	Low acceptance	Conditional acceptance High acceptance	
1	“V2G makes the charging potentially very slow”	“V2G is a better way of charging”, “would purchase a V2G station ... if it were possible”	High
2		“the barrier of controlling the minimum charge [is] ... very important for adoption. Only then would V2G ... suit my lifestyle”	Medium
3	“the technology is not ready for adoption”	“[I am now] more aware of the potential of V2G”	Low
4		“[If I] include bi-directional technology for a vehicle-to-home setup [I could become my] own island of power”, “V2G [is] a better way of charging compared to conventional (smart) chargers”, “V2G would fit [my] lifestyle and work schedule.”	High

Continued on the next page

Table 7.2 – continued from the previous page

I _{Ex} No.	Quotations from transcripts		Degree of Acceptance
	Low acceptance	High acceptance	
5		<p>“would choose for V2G if it was available for purchase, but ... the costs of decreased battery life should be covered”</p> <p>“[I] hope V2G is adopted in society quickly”, “V2G [is] a better way of charging”, “the technology is already developed beyond the prototype stage”</p>	High
6		<p>“would ... not recommend a V2G car to others, unless they lived in a country like the Netherlands where everything is close by”</p>	High
7	<p>“V2G would not directly suit [my] lifestyle ... [I] would like more comfort and certainty”, “Even when financial benefits outweigh the costs of battery degradation ... [I] would not opt for V2G as the uncertainty in range is a very big drawback”</p>	<p>“[I] worry about the state of charge when departing ... there should be some way to eliminate this worry [like] setting a minimum battery percentage”, “ If the car had V2G ... [I] should at least be able to opt out of it”, “[I] would recommend V2G to others who have societal and environmental motives”</p>	Low

Continued on the next page

Table 7.2 – continued from the previous page

I _{Ex} No.	Quotations from transcripts		Degree of Acceptance
	Low acceptance	Conditional acceptance High acceptance	
8	<i>“[I] believe V2G should not decrease the level of comfort in driving, and especially should not feel like a penalty”</i>		Low
9	<i>“[Whether I] would buy ... a V2G-enabled car ... really depends on what is in it for me.”</i> , <i>“If the control barrier is taken away, V2G would fit [my] work and personal lifestyle schedule”</i>	<i>“Switching from an ICE car to an EV is already a big step, so including V2G in this is a small price”</i>	Medium
10	<i>“One requirement ... for adoption is a way to set a minimum distance ... you don’t want the feeling of not being in control”, “To fit [my] personal and working life ... V2G should not be too much of a ‘communal’ technology. [I] still value [the] personal freedom a personal vehicle should provide.”</i>	<i>“[I] would like to have V2G functionality when purchasing an EV, with the main benefit of cost reduction for [me] or [my] employer”</i>	Medium

Continued on the next page

Table 7.2 – continued from the previous page

I _{Ex} No.	Quotations from transcripts		Degree of Acceptance
	Low acceptance	High acceptance	
11		<p>“[I] do not think V2G fits [my] lifestyle, but [I am] so fond of V2G that [I’d] like to change [my] lifestyle to fit the technology”, “V2G [is] superior to conventional chargers.”</p>	High
12	<p>“V2G does not suit [my] lifestyle ... in the city [where there is] no room for a car.”</p>	<p>“[I] would buy a car with bi-directional capabilities when [I] own a detached house”, “the V2G charging station [is] as easy to use as conventional charging stations, and thanks to the additional functionality ... may [be] superior.”</p>	Medium
13	<p>“Certain barriers ... need to be overcome for consumers to accept the technology.”</p>		Medium

Continued on the next page

Table 7.2 – continued from the previous page

I _{Ex} No.	Quotations from transcripts		Degree of Acceptance
	Low acceptance	Conditional acceptance High acceptance	
14	<p><i>“did not find it practical for personal use”, “V2G could in theory work for [my] daily life, but practically ... it will not because of the lack of freedom”</i></p>	<p><i>“would not recommend anyone else purchasing an EV with V2G until certain barriers are overcome”, “V2G is only a desirable option if there is a guarantee you have enough charge the next day”</i></p>	Low
15		<p><i>“In the future, when sufficient income is generated ... [I] ... would like [V2G] functionality in addition to traditional charging capabilities”, “After participating ... [I] consider [V2G] to be a better way of charging as compared to conventional charging”</i></p>	High
16		<p><i>“V2G is a better way to charge when control options are embedded as the main goal when connecting to a charging station is to charge your car”, “would only advise [other] to purchase V2G if ... they have control and insight over the range”</i></p>	Medium

Continued on the next page

Table 7.2 – continued from the previous page

I _{Ex} No.	Quotations from transcripts	Degree of Acceptance
17	<div style="display: flex; justify-content: space-between;"> <div style="text-align: center;">Low acceptance</div> <div style="text-align: center;">Conditional acceptance</div> <div style="text-align: center;">High acceptance</div> </div> <p data-bbox="336 757 464 1142"><i>“[I would like my first EV] to offer V2G capability, but [I] should have the option to choose whether to enable V2G for each session”</i></p>	Medium

However, we distinguish between the consumer acceptance of V2G charging measured in a controlled research environment as in this study, and V2G usage in a commercial setting (shown at the extreme right of the resulting model in Fig. 7.5. Although participants in trials may state preferences, their behaviour in real world settings can differ. In literature, this is variously described as the degree of intention-behaviour correlation by Ajzen [34] and the Knowledge-Attitude-Practice (KAP) gap by Rogers [43]. However, given no significant barriers in terms of behavioural control, behavioural intention is found to predict actual behaviour quite accurately [34]. In the context of our study, the measured indicator, *consumer acceptance of V2G charging* would be a good indicator of commercial *V2G usage* if the perceived ease of use of V2G charging is high. In the absence of running trials in fully commercial environments, trials like the one conducted in this study in operational environments can thus provide a good idea of future commercial use.

7.4.5 COMPARISON OF RESULTS WITH LITERATURE

Our results are found to agree with some findings in literature while conflicting with others. The results here show a less favourable attitude towards V2G charging than those obtained through surveys among (mainly) ICE vehicle users in Germany in [16]. However, as in the earlier study, range anxiety is found to be a more important factor than concern about battery effects. Although we did not evaluate the willingness to pay for adding V2G capability to EVs as in [17], where extensive surveys were conducted in several Nordic countries, we find our results to show a more favourable outlook for V2G adoption.

Unlike multiple German studies [16, 27], where financial compensation was not found to be important, we find compensation to be an important factor among our interviewees. We suggest two hypotheses for these differences: Will and Schuller [27] studied only unidirectional smart charging, which differs considerably from V2G charging, particularly in terms of the effects on the EV battery and the associated financial consequences, as well in terms of range anxiety. Both these were found to be closely linked with compensation in our interview results. Secondly, the degree of EV adoption in the Netherlands at the time of writing is considerably higher than that in Germany as surveyed by Geske and Schumann [16], which likely included innovators and extremely early adopters. Economic motivators are expected to play a more important role among later adopters of technology.

Delmonte et al. [28] found that two thirds of the 60 participants interviewed after participating in a smart charging trial in the UK preferred to manage charging profiles based on Time-of-Use electricity prices themselves rather than having a supplier manage them on their behalf. Although the participants in our study were not given such a

choice, nearly all of them expressed a desire to set limits and potentially opt out of V2G charging. There was, however, no explicitly stated desire to steer the system in real time. In contrast, results from I_{NoEx} indicated that participants did not wish to be burdened by continuous notifications - a summarised report was considered more suitable. Our results are also similar to those in [44], where nearly all of the 89 participants in an EV smart charging trial expressed that an override button was either essential for participation or a good option that would lower the barrier for acceptance.

In our study the knowledge about EVs and charging among the interviewees was particularly high. This is demonstrated by participants knowing the difference between battery degradation impacts on energy capacity and battery lifetime, the effects of the depth of discharge in cycling on battery health and decision to use an app to more accurately estimate the Nissan LEAF's range based on battery SoC than the estimate provided by the car itself. In studies which include ICE vehicle drivers [16, 17], participants are extremely unlikely to have such detailed knowledge of EVs, batteries and charging, making their stated choices relatively uninformed. These factors are however, present in expert interviews [19, 20] and academic reviews [10, 11], highlighting their importance for decision-making.

7.4.6 OUTLOOK ON WIDER V2G ACCEPTANCE

Our results show that a large section of participants in the study show conditional acceptance of V2G charging. Particularly important for their use of the system are the provision of insight into the battery SoC, the ability to control operational parameters, adequate compensation for battery degradation and the degree with which they perceive V2G charging to disrupt their routines and sense of freedom.

Access to an owned or leased EV was a requirement for participation in I_{NoEx} and the prior use of an EV was required to participate in I_{Ex} . Since commercial EVs still form a relatively small (though quickly expanding) share of the total Dutch passenger vehicle fleet⁹, we expect early adopters of electric mobility to form a large part of our sample. These early EV adopters have been found, in several studies, to have high education levels, high incomes and environmental awareness [39, 46, 47] Further, the recruitment of participants was done in an engineering university, and the advertisement for participants required them to sign up themselves. As such, our sampling suffers from selection bias and our sample is likely to be both more technically-educated as well as more enthusiastic about technology than the general public.

Our set of interviewees, though similar in distribution to the current Dutch EV driving population, is not a representative sample of the Dutch vehicle driving population. We specifically expect to have overlooked female, elderly, less educated, less wealthy and

⁹ around 4% as of October 2021 [45]

rural vehicle users. As the electrification of mobility progresses, the demographics of the expanding EV driving population are expected to shift towards those of the larger population of vehicle drivers.

The ability our findings to predict the consumer acceptance among future EV users remains uncertain. However, it seems likely that for the later adopters of EVs, the reliability of charging, economic benefits and ease of use are likely to be greater barriers to V2G use than for the interviewees in this study. They may also be less likely to be motivated by innovative technology and environmental concerns. However, with increased EV adoption, while the *fraction of EV users* who accept V2G charging is likely to reduce, we still expect the *total population of V2G users* to increase.

Research shows that early adopters of EVs have similar profiles around the world. They also drive one of a limited set of vehicles produced by major EV manufacturers. We therefore expect our results to also provide insights on consumer acceptance of V2G charging in other countries other than the Netherlands. A few conditions specific to the Netherlands are however worth noting. Company lease of EVs is particularly high in the Netherlands, at over 50% [48]. This may result in different results from countries where private ownership is the norm. Travelling in the Netherlands also typically involves relatively short driving distances over a flat landscape, and the country has a well developed public EV charging network both in urban areas as well as fast charging along highways. All these features are likely to influence the way users perceive range and experience range anxiety, both of which are important determinants of the consumer acceptance of V2G charging.

The future use of V2G is also likely to be affected by developments in passenger mobility, policy targets and alternative technologies offering similar value as V2G charging. The technology and standards influencing V2G technology and the markets in which V2G-compatible EVs would participate are also evolving rapidly. An important factor is the availability of charging infrastructure and the capacity of the electricity grid to integrate the scaled charging of EVs.

7.5 CONCLUSIONS

In this chapter, we investigate the consumer acceptance of V2G among electric vehicle drivers in the Netherlands. The use of EVs to store and discharge electricity through V2G charging can enable the greater use of available grid capacity, reducing the need for reinforcements and grid expansion. Both V2G charging stations as well as V2G compatible vehicles are commercially available. However, EV users' acceptance of the use of their EVs for V2G charging remains a significant but understudied barrier to the utilisation of the EV fleet to support the grid. This research provides insight into this acceptance among EV users with a view to overcoming these barriers and enabling the

aggregated storage assets of the parked EV fleet to intelligently make use of the scarce capacity in the electricity grid.

Qualitative methods were used in this study, which is explorative in nature. Initially, a literature review was conducted to develop an interview protocol. 37 semi-structured interviews were conducted in two stages:

1. 20 interviews before experiencing V2G charging (\mathbf{I}_{NoEx})
2. 17 Interviews after experiencing V2G charging (\mathbf{I}_{Ex})

\mathbf{I}_{NoEx} involved interviews with 20 Dutch EV drivers. Later, a test setup including an operational V2G charging station was constructed at the Green Village, a living lab for innovative technologies. 17 participants recruited for \mathbf{I}_{Ex} were then given the opportunity to charge a project-owned Nissan LEAF for at least a week each. Semi-structured interviews were then conducted with these 17 \mathbf{I}_{Ex} participants.

The literature and the insights from the \mathbf{I}_{NoEx} interviews helped to identify the factors important for consumer acceptance of V2G. The \mathbf{I}_{Ex} interviews were then conducted to either validate which of these factors were actually of relevance to users who had actually experienced V2G charging.

The results from the \mathbf{I}_{Ex} interviews showed that range anxiety in various forms, compensation and battery degradation were the most important determinants of the consumer acceptance of V2G charging. Clear communication of the impacts of V2G charging cycles on EV batteries, financial compensation covering these impacts, real time insight on the battery SoC and the ability to set operational parameters through a user-friendly interface were all found to foster acceptance. The main barriers for acceptance were the uncertainty associated with battery SoC, the increased need for planning charging and trips, the increased anxiety about the ability of the vehicle to reach its destination, economic and performance related effects on the EV's battery and the restriction of the freedom that users associated with their personal vehicles.

Several participants expressed that their future use of V2G charging required certain conditions to be met. The most important ones were:

1. Clear communication about the economic benefits for them, the battery effects and the societal/ environmental value
2. Financial compensation covering at least the battery degradation caused
3. Transparency on battery charging and status in real time
4. Ability to set parameters on operation and to opt out of V2G charging

These lead to clear recommendations for the design of V2G charging hardware and software that would lead to higher consumer acceptance. The most cited reasons for low

acceptance among participants were a perceived loss of freedom and certainty. Better insight on the system operation and a higher degree of control for users would also help address these concerns.

The research found compensation to be a more important factor than in previous studies. Control of V2G charging cycles proved to be popular among our interviewees; however, the preferences were for setting parameters around minimum battery capacity, minimum range and so on, rather than actively steering the charging itself, which was preferred by participants in earlier trials. The high degree of knowledge among the users in this research enabled them to express informed opinions about details of EVs and V2G charging that were earlier discussed only by experts.

The ability of our results to predict consumer acceptance of V2G charging among future EV users as electric mobility diffuses further is uncertain. We show that consumer acceptance is high among a section of current users, who are early adopters, while the majority requires certain conditions to be met before they would use V2G charging. We expect this fraction to reduce over time as the demographics of the EV driving population evolves, but the overall number of drivers with high acceptance to increase in the future.

The explorative research performed here provides the basis for detailed future work on consumer preferences. In future trials, detailed insights on specific contractual elements can be obtained, with more quantitative results on the willingness to participate, willingness to pay and so on. Divergent views among the participants in this study can also be used to better categorise EV drivers into representative archetypes, who might value V2G charging differently or have different barriers for acceptance.

7.6 APPENDIX A: OPERATION OF THE V2G SETUP

The operation of the V2G setup located at the solar carport in Delft is described in Fig 7.6, which shows power measurements made on the 4th of September 2020.

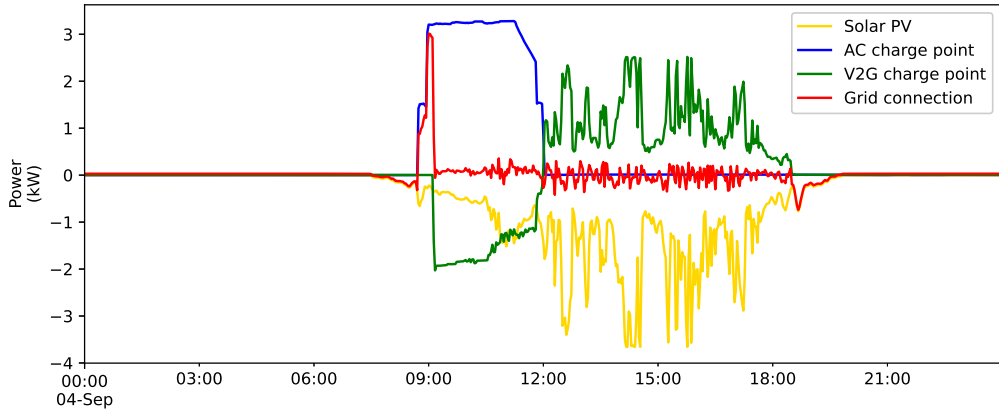

Figure 7.6: Operation of the V2G setup at the Green Village on 4th September 2020

In the figure, electrical loads and battery charging are taken as positive, while electricity production and battery discharging are taken as negative. The power measured at the grid connection is superimposed on the other plots for descriptive purposes, with feed-in as negative and purchase as positive.

Shortly before 9 a.m. in the morning, a PHEV began charging at the AC charger, as shown in blue. Solar production was quite low this early in the morning, seen in yellow. This resulted in electricity being purchased from the grid, shown in red. One of the participants in \mathbf{I}_{E_x} arrived with the Nissan LEAF soon after 9 a.m., and plugged in at the V2G charge point, shown in green.

The LEAF began to discharge (negative), resulting in lower power purchased from the grid, while the PHEV continued to charge until noon. As the solar production increased, it contributed towards the charging of the PHEV, reducing the power that needed to be provided by the LEAF. The PHEV battery reached a high state of charge, shifting from the constant current to the constant voltage region of charging, seen in the downward slope of the blue line around noon. After this, it stopped charging.

The Nissan LEAF then switched from V2G mode to charging mode. The charging power followed the solar PV power generation, whose variability shows that it was a day with intermittent cloud cover in Delft. This ensured that the power needed from the grid (in red) remained close to zero.

After 6 p.m., the Nissan LEAF was unplugged and driven away by the participant. A small amount of solar electricity produced after the LEAF was unplugged was fed into the grid. Over the entire day, the grid capacity requirements of both the feed-in of solar energy and the demand for charging power were reduced considerably through the use of the V2G charge point.

REFERENCES

- [1] Kempton, W., Letendre, S. E., “Electric vehicles as a new power source for electric utilities.” In: *Transportation Research Part D: Transport and Environment* 2.3 (1997), pp. 157–175. ISSN: 13619209. DOI: 10.1016/S1361-9209(97)00001-1. URL: <https://linkinghub.elsevier.com/retrieve/pii/S1361920997000011>.
- [2] Kempton, W., Tomić, J., “Vehicle-to-grid power implementation: From stabilizing the grid to supporting large-scale renewable energy.” In: *Journal of Power Sources* 144.1 (2005), pp. 280–294. ISSN: 03787753. DOI: 10.1016/j.jpowsour.2004.12.022. URL: <https://linkinghub.elsevier.com/retrieve/pii/S0378775305000212>.
- [3] MacLeod, M., Cox, C., *V2G Market Study - Answering the preliminary questions for V2G: What, where and how much?* Loughborough, England: Cenex, 2018. URL: <https://www.seev4-city.eu/wp-content/uploads/2018/08/V2G-Market-Study-2018.pdf>.
- [4] EVTEC, *Datasheet EVTEC V2G charger*. 2020. URL: https://www.evtec.ch/files/2415/8058/6403/factsheet_sospesocharge_bidirectional_en.pdf (visited on 07/29/2020).
- [5] VenemaTech, *Vehicle-to-grid DC Laadsysteem 10kW*. VenemaTech. 2020. URL: <https://www.venematech.shop/v2g-dc-laadsysteem-10kw.html?source=facebook> (visited on 07/29/2020).
- [6] OVO Energy, *V2G Charger User Guide*. 2020. URL: <https://www.ovoenery.com/guides/electric-cars/vehicle-to-grid-technology> (visited on 07/29/2020).
- [7] TenneT, T. *Equigy: Crowd Balancing Platform*. Equigy. Library Catalog: equigy.com. 2022. URL: <https://equigy.com/> (visited on 05/27/2020).
- [8] GOPACS. 2022. URL: <https://en.gopacs.eu/> (visited on 11/15/2021).
- [9] Parliament, E. *Directive (EU) 2019/944 of the European Parliament and of the Council of 5 June 2019 - on common rules for the internal market for electricity and amending Directive 2012/27/EU*. 2019. URL: <https://eur-lex.europa.eu/legal-content/EN/TXT/PDF/?uri=CELEX:32019L0944&from=EN>.
- [10] Sovacool, B. K., Axsen, J., Kempton, W., “The Future Promise of Vehicle-to-Grid (V2G) Integration: A Sociotechnical Review and Research Agenda.” In: *Annual Review of Environment and Resources* 42.1 (2017), pp. 377–406. ISSN: 1543-5938. DOI: 10.1146/annurev-environ-030117-020220. URL: <https://www.annualreviews.org/doi/10.1146/annurev-environ-030117-020220>.
- [11] Sovacool, B. K., Noel, L., Axsen, J., Kempton, W., “The neglected social dimensions to a vehicle-to-grid (V2G) transition: a critical and systematic review.” In: *Environmental Research Letters* 13.1 (2018), pp. 1–18. ISSN: 1748-9326. DOI: 10.1088/1748-9326/aa9c6d. URL: <http://stacks.iop.org/1748-9326/13/i=1/a=013001?key=crossref.9203e40373b5f1d7115356d673378c1b>.
- [12] Park Lee, E. H. “A socio-technical exploration of the Car as Power Plant.” PhD thesis. Delft, the Netherlands: Delft University of Technology, 2019. DOI: 10.4233/uuid:bcf14d54-74cc-4fe8-9285-466cee3936ab. URL: <http://resolver.tudelft.nl/uuid:bcf14d54-74cc-4fe8-9285-466cee3936ab>.
- [13] Gschwendtner, C., Sinsel, S. R., Stephan, A., “Vehicle-to-X (V2X) implementation: An overview of predominant configurations and technical, social and regulatory challenges.” In: *Renewable and Sustainable Energy Reviews* 145 (2021), p. 110977. ISSN: 1364-0321. DOI: 10.1016/j.rser.2021.110977. URL: <https://www.sciencedirect.com/science/article/pii/S1364032121002690>.
- [14] Huijts, N. M. A., Molin, E. J. E., Steg, L., “Psychological factors influencing sustainable energy technology acceptance: A review-based comprehensive framework.” In: *Renewable and Sustainable Energy Reviews* 16.1 (2012), pp. 525–531. ISSN: 1364-0321. DOI: 10.1016/j.rser.2011.08.018.
- [15] Parsons, G. R., Hidrue, M. K., Kempton, W., Gardner, M. P., “Willingness to pay for vehicle-to-grid (V2G) electric vehicles and their contract terms.” In: *Energy Economics* 42 (2014), pp. 313–324. ISSN: 0140-9883. DOI: 10.1016/j.eneco.2013.12.018. URL: <http://www.sciencedirect.com/science/article/pii/S0140988314000024>.

- [16] Geske, J., Schumann, D., “Willing to participate in vehicle-to-grid (V2G)? Why not!” In: *Energy Policy* 120 (2018), pp. 392–401. ISSN: 0301-4215. DOI: 10.1016/j.enpol.2018.05.004. URL: <http://www.sciencedirect.com/science/article/pii/S0301421518302982>.
- [17] Noel, L., Papu Carrone, A., Jensen, A. F., Zarazua de Rubens, G., Kester, J., Sovacool, B. K., “Willingness to pay for electric vehicles and vehicle-to-grid applications: A Nordic choice experiment.” In: *Energy Economics* 78 (2019), pp. 525–534. ISSN: 0140-9883. DOI: 10.1016/j.eneco.2018.12.014. URL: <http://www.sciencedirect.com/science/article/pii/S0140988318304961>.
- [18] Hidrue, M. K., Parsons, G. R., Kempton, W., Gardner, M. P., “Willingness to pay for electric vehicles and their attributes.” In: *Resource and Energy Economics* 33.3 (2011), pp. 686–705. ISSN: 0928-7655. DOI: 10.1016/j.reseneeco.2011.02.002. URL: <http://www.sciencedirect.com/science/article/pii/S0928765511000200> (visited on 11/05/2020).
- [19] Kester, J., Noel, L., Zarazua de Rubens, G., Sovacool, B. K., “Promoting Vehicle to Grid (V2G) in the Nordic region: Expert advice on policy mechanisms for accelerated diffusion.” In: *Energy Policy* 116 (2018), pp. 422–432. ISSN: 0301-4215. DOI: 10.1016/j.enpol.2018.02.024. URL: <http://www.sciencedirect.com/science/article/pii/S0301421518300995>.
- [20] Noel, L., Zarazua de Rubens, G., Kester, J., Sovacool, B. K., “Navigating expert skepticism and consumer distrust: Rethinking the barriers to vehicle-to-grid (V2G) in the Nordic region.” In: *Transport Policy* 76 (2019), pp. 67–77. ISSN: 0967-070X. DOI: 10.1016/j.tranpol.2019.02.002. URL: <http://www.sciencedirect.com/science/article/pii/S0967070X17308338>.
- [21] Sovacool, B. K., Kester, J., Noel, L., Rubens, G. Z., “Contested visions and sociotechnical expectations of electric mobility and vehicle-to-grid innovation in five Nordic countries.” In: *Environmental Innovation and Societal Transitions* 31 (2019), pp. 170–183. ISSN: 2210-4224. DOI: 10.1016/j.eist.2018.11.006. URL: <http://www.sciencedirect.com/science/article/pii/S2210422418301886>.
- [22] Zonneveld, J. “Increased Participation in V2G through contract elements: Examining the preferences of Dutch EV users regarding V2G contracts using a stated choice experiment.” Master thesis. Delft, the Netherlands: Delft University of Technology, 2019. URL: <https://repository.tudelft.nl/islandora/object/uuid%3A3024ac31-b822-444b-a823-fe2951ad0ec7>.
- [23] Meijssen, A. “Dutch electric vehicle drivers’ preferences regarding vehicle-to-grid contracts: Examining the willingness to participate in vehicle-to-grid contracts by conducting a context-dependent stated choice experiment taking into account the EV recharging speed.” Master thesis. Delft, the Netherlands: Delft University of Technology, 2019. URL: <https://repository.tudelft.nl/islandora/object/uuid%3A0cb03a83-148a-48b6-bb14-32a46fdb4e01>.
- [24] Cenex UK, *Project Scurius Trial Insights: Findings from 300 Domestic V2G Units in 2020*. Loughborough, England, 2021. URL: <https://www.cenex.co.uk/projects-case-studies/sciurus/>.
- [25] Pettersson, S. *ELVIIS: Final Report to Göteborg Energi Forskningsstiftelse*. Göteborg, Sweden: Swedish ICT, 2013. URL: https://www.viktoria.se/sites/default/files/pub/www.viktoria.se/upload/publications/elviis_final.pdf.
- [26] Schmalfuß, F., Mair, C., Döbel, S., Kämpfe, B., Wüstemann, R., Krems, J. F., Keinath, A., “User responses to a smart charging system in Germany: Battery electric vehicle driver motivation, attitudes and acceptance.” In: *Energy Research & Social Science* 9 (2015), pp. 60–71. ISSN: 22146296. DOI: 10.1016/j.erss.2015.08.019. URL: <https://linkinghub.elsevier.com/retrieve/pii/S2214629615300426>.
- [27] Will, C., Schuller, A., “Understanding user acceptance factors of electric vehicle smart charging.” In: *Transportation Research Part C: Emerging Technologies* 71 (2016), pp. 198–214. ISSN: 0968090X. DOI: 10.1016/j.trc.2016.07.006. URL: <https://linkinghub.elsevier.com/retrieve/pii/S0968090X16301127>.
- [28] Delmonte, E., Kinnear, N., Jenkins, B., Skippon, S., “What do consumers think of smart charging? Perceptions among actual and potential plug-in electric vehicle adopters in the United Kingdom.” In: *Energy Research & Social Science* 60 (2020), p. 101318. ISSN: 2214-6296. DOI: 10.1016/j.erss.2019.101318. URL: <http://www.sciencedirect.com/science/article/pii/S2214629619301422>.
- [29] Schneider, U., Dütschke, E., Peters, A., “How Does the Actual Usage of Electric Vehicles Influence Consumer Acceptance?” In: *Evolutionary Paths Towards the Mobility Patterns of the Future*. Ed. by M. Hülsmann and D. Fornahl. Lecture Notes in Mobility. Berlin, Heidelberg: Springer, 2014, pp. 49–66. ISBN: 978-3-642-37558-3. DOI: 10.1007/978-3-642-37558-3_4. URL: https://doi.org/10.1007/978-3-642-37558-3_4.

- [30] Jensen, A. F., Cherchi, E., Mabit, S. L., “On the stability of preferences and attitudes before and after experiencing an electric vehicle.” In: *Transportation Research Part D: Transport and Environment* 25 (2013), pp. 24–32. ISSN: 1361-9209. DOI: 10.1016/j.trd.2013.07.006. URL: <http://www.sciencedirect.com/science/article/pii/S1361920913001077>.
- [31] Franke, T., Krems, J. F., “Understanding charging behaviour of electric vehicle users.” In: *Transportation Research Part F: Traffic Psychology and Behaviour* 21 (2013), pp. 75–89. ISSN: 13698478. DOI: 10.1016/j.trf.2013.09.002. URL: <https://linkinghub.elsevier.com/retrieve/pii/S1369847813000776>.
- [32] Bunce, L., Harris, M., Burgess, M., “Charge up then charge out? Drivers’ perceptions and experiences of electric vehicles in the UK.” In: *Transportation Research Part A: Policy and Practice* 59 (2014), pp. 278–287. ISSN: 0965-8564. DOI: 10.1016/j.tra.2013.12.001. URL: <https://www.sciencedirect.com/science/article/pii/S0965856413002395>.
- [33] Shaheen, S. A., Martin, E., Lipman, T. E., “Dynamics in Behavioral Response to Fuel-Cell Vehicle Fleet and Hydrogen Fueling Infrastructure: An Exploratory Study.” In: *Transportation Research Record* 2058.1 (2008). Publisher: SAGE Publications Inc, pp. 155–162. ISSN: 0361-1981. DOI: 10.3141/2058-19. URL: <https://doi.org/10.3141/2058-19>.
- [34] Ajzen, I. “The theory of planned behavior.” In: *Organizational Behavior and Human Decision Processes. Theories of Cognitive Self-Regulation* 50.2 (1991), pp. 179–211. ISSN: 0749-5978. DOI: 10.1016/0749-5978(91)90020-T. URL: <http://www.sciencedirect.com/science/article/pii/074959789190020T>.
- [35] Hoekstra, A., Refa, N., “Characteristics of Dutch EV drivers.” In: *EVS30 Symposium. 30th International Electric Vehicle Symposium and Exhibition. Stuttgart, Germany, 2017*.
- [36] Edwards, T., Landi, M., *V2G Global Roadtrip: Around the World in 50 Projects*. London, UK: UK Power Networks and Innovate UK, 2018. URL: <https://www.evconsult.nl/wp-content/uploads/2018/10/Final-Report-UKPN001-5-01-I-V2G-global-review.pdf>.
- [37] *V2G Around the world*. V2G Hub. 2021. URL: <https://www.v2g-hub.com/> (visited on 11/17/2021).
- [38] Huang, B., Meijssen, A. G., Annema, J. A., Lukszo, Z., “Are electric vehicle drivers willing to participate in vehicle-to-grid contracts? A context-dependent stated choice experiment.” In: *Energy Policy* 156 (2021), p. 112410. ISSN: 0301-4215. DOI: 10.1016/j.enpol.2021.112410. URL: <https://www.sciencedirect.com/science/article/pii/S03014215211002809>.
- [39] Plötz, P., Schneider, U., Globisch, J., Dütschke, E., “Who will buy electric vehicles? Identifying early adopters in Germany.” In: *Transportation Research Part A: Policy and Practice* 67 (2014), pp. 96–109. ISSN: 0965-8564. DOI: 10.1016/j.tra.2014.06.006. URL: <http://www.sciencedirect.com/science/article/pii/S0965856414001463>.
- [40] Sovacool, B. K., Kester, J., Noel, L., Rubens, G. Z., “The demographics of decarbonizing transport: The influence of gender, education, occupation, age, and household size on electric mobility preferences in the Nordic region.” In: *Global Environmental Change* 52 (2018), pp. 86–100. ISSN: 0959-3780. DOI: 10.1016/j.gloenvcha.2018.06.008. URL: <https://www.sciencedirect.com/science/article/pii/S095937801830030X>.
- [41] Maltha, Y., Kroesen, M., Wee, B., Daalen, E., “Changing Influence of Factors Explaining Household Car Ownership Levels in the Netherlands.” In: *Transportation Research Record* 2666 (2017), pp. 103–111. ISSN: 0361-1981. DOI: 10.3141/2666-12. URL: <http://resolver.tudelft.nl/uuid:954ff13f-9d19-48c7-89e5-622af3b204b7>.
- [42] Centraal Bureau voor de Statistiek (CBS), *Car fleet growing faster than population*. Statistics Netherlands. 2020. URL: <https://www.cbs.nl/en-gb/news/2020/10/car-fleet-growing-faster-than-population> (visited on 11/18/2021).
- [43] Rogers, E. M. *Diffusion of Innovations*. 4th ed. New York: Simon and Schuster, 2010. 550 pp. ISBN: 978-1-4516-0247-0.
- [44] Bokhoven, P., Gardien, L., Klapwijk, P., Refa, N., Berende, M., Zante, A., Heinen, J. W., Kats, R., *Charge management of electric vehicles at home: Testing smart charging with a home energy management system*. Elaad NL, 2020. URL: https://www.enpuls.nl/media/m41nbccf/rapport_charge-management-of-electric-vehicles-at-home.pdf.

- [45] Netherlands Enterprise Agency (RVO), *Statistics Electric Vehicles and Charging in The Netherlands up to and including October 2021*. 2021. URL: <https://www.rvo.nl/onderwerpen/duurzaam-ondernemen/energie-en-milieu-innovaties/elektrisch-rijden/stand-van-zaken/cijfers-elektrisch-vervoer>.
- [46] Carley, S., Krause, R. M., Lane, B. W., Graham, J. D., “Intent to purchase a plug-in electric vehicle: A survey of early impressions in large US cities.” In: *Transportation Research Part D: Transport and Environment* 18 (2013), pp. 39–45. ISSN: 1361-9209. DOI: 10.1016/j.trd.2012.09.007. URL: <http://www.sciencedirect.com/science/article/pii/S1361920912001095>.
- [47] Hardman, S., Shiu, E., Steinberger-Wilckens, R., “Comparing high-end and low-end early adopters of battery electric vehicles.” In: *Transportation Research Part A: Policy and Practice* 88 (2016), pp. 40–57. ISSN: 0965-8564. DOI: 10.1016/j.tra.2016.03.010. URL: <http://www.sciencedirect.com/science/article/pii/S0965856416302208>.
- [48] Kampert, A., Ewalds, D., *Haalbaarheidsonderzoek: Aandeel private lease elektrische personenauto’s bij rechtspersonen in de RDW*. The Hague, the Netherlands: Centraal Bureau voor de Statistiek, 2018. URL: <https://www.cbs.nl/nl-nl/maatwerk/2018/17/private-lease-elektrische-personenauto-s>.

CONCLUSIONS

In this chapter, we initially describe the conclusions of this thesis, answering the initially stated research questions. We then describe how the thesis is related with recent developments outside academia. Concrete recommendations are provided for engineers in the solar and EV sectors, researchers and policy makers based on the evidence and arguments compiled in this thesis. Finally, we discuss interesting directions for future research.

8.1 ANSWERS TO THE RESEARCH QUESTIONS

This thesis aims to answer the stated research question:

‘To what extent does the coupling of solar carpark and electric vehicle charging reduce the impact on the grid and on CO₂ emissions?’

by answering the sub-questions as follows:

1. *Which configurations of solar carpark systems for electric vehicle charging reduce the grid capacity required and CO₂ emissions associated with charging?*

Carparks for EV charging at workplaces and carparks for long-term parking were identified as the most interesting locations for the deployment of solar carparks for EV charging. Solar generation profiles at workplaces were found to have a high temporal match with the EV demand profiles at these locations. This had the result of reducing the grid capacity required by between 16 and 40%, through the scheduling of EV charging. Charging of EVs at solar carports also resulted in a reduction in the annual greenhouse gas emissions associated with EV charging over the operational phase of the vehicle’s lifecycle.

At longterm parking locations, where EVs remain parked for over 24 hours, the low power requirements for charging enables offgrid solar photovoltaic arrays to meet charging demand. Charging of EV at these location is possible with a minimal grid connection capacity and therefore nearly eliminates the emissions associated with grid electricity.

2. *To what extent does controlled charging reduce the grid capacity required and CO₂ emissions associated with EV charging?*

At a workplace solar carpark, model predictive control (MPC) was used to schedule the charging of EVs in the parking lot, leading to a lower annual peak EV charging demand by 16% relative to immediate charging. The inclusion of a single EV demand forecast based on average historic EV demand was found to reduce annual peak EV charging demand by 36% relative to immediate charging. Scheduling of EV charging to reduce demand peaks over a range of possible future EV demands reduced annual demand peaks by 39%.

We find that battery storage does not contribute to offset of carbon emissions by solar carports. This result was found to be valid across calculation methodologies using the annual average, the hourly average as well as the hourly marginal carbon intensity of electricity consumed in the Dutch grid. Controlled EV charging at residential areas based on hourly electricity prices in the Dutch Day Ahead market was also found to have minimal contribution to the offset of carbon emissions.

At the analysed offgrid longterm solar carpark, when the grid connection and associated emissions are eliminated completely, not all the vehicles are fully charged at departure. 20% of EVs over the year leave with a state-of-charge lower than 60% and 3% with a state-of-charge lower than 40%. The adequacy of fleet-level charging is lowest during the low irradiance month of December, during which 63% of vehicles leave with a state-of-charge lower than 60% and 11% lower than 40%. Prioritising the charging of plugged-in vehicles with the lowest state-of-charge was found to ensure that no vehicles leaving with state-of-charge lower than 40% over the year. Another strategy of increasing the minimum duration of parking had the effect of reducing the fraction of vehicles leaving with state-of-charge below 60% by about 2% per day.

3. *How willing are EV users to accommodate controlled charging through V2G and under what conditions?*

The majority of participants interviewed were found to accept or conditionally accept V2G charging. This result was found in both a sample of EV drivers without experience of V2G charging as well as in a sample where each participant used a V2G compatible Nissan LEAF and experienced V2G charging for a week. The most important conditions to be fulfilled to make V2G technology more widely acceptable are:

- The electricity charged and discharged by the vehicle should be visible to the vehicle user.
- The vehicle user should have control over vehicle charging so that they can opt out of discharging events.

- The vehicle user should be provided compensation for V2G charging to cover both the battery degradation as well as the resulting perceived loss of freedom associated with access to a private vehicle.

In summary, the extent of coupling of solar carparks and electric vehicles reduces the impact on the grid differs by location. At workplaces, where the charging demand is for commuting passenger vehicles, scheduled charging lowers the annual demand peaks by up to 40%. Solar carports for EV charging at workplaces result in net carbon saving after 3 to 4.7 years of operation. Controlled charging based on prices and battery storage do not contribute to increased carbon offset. Solar parking lots at longterm parking locations can eliminate the grid capacity and associated charging. However, this comes at a trade-off with 20% of vehicles leaving with lower than 60% state of charge. A charging algorithm or a minimal grid capacity are therefore recommended to ensure all vehicles are fully charged at departure.

8.2 CONNECTION WITH RECENT DEVELOPMENTS

In the years during which this thesis was written, the availability of capacity in the electricity grid to transport electricity from generation to demand has reduced even further.

In the Dutch grid, several recent indicators show this decrease in capacity:

1. After November 2020, new solar PV installations requiring a large consumer grid connection were provided a maximum of 70% connection capacity relative to the installed capacity of the solar array [1]. Since April 2022, a maximum of 50% of grid capacity is now provided¹.
2. New solar installations beyond a certain size are required to be controllable and capable of being shut off [1].
3. In 2022, the Dutch TSO, TenneT announced that no new new or higher capacity grid connections will be provided to large consumers in the provinces of North Brabant and Limburg as a temporary measure due to lack of transmission capacity [4].

In other parts of the world, although at different stages of the energy transition and with different geographical conditions and energy mixes, similar symptoms of low grid capacity are seen in regions with high shares of renewable energy. As an example, about 5 GWh² of (mainly onshore wind) energy were curtailed in the Schleswig-Holstein and

¹ This policy change was based on a study performed by the Netherlands Environmental Agency [2] and subsequently incorporated in the requirements for the 2022 round of the SDE++, the national subsidy mechanism for sustainable energy projects [3]

² This comprised about 3.8% of Germany's total wind production of 132 GWh in 2020 [5].

Lower Saxony regions in Germany in 2020, which together have about a third of German installed wind capacity [6]. There is a widespread shortage of grid capacity across all five of the US synchronous zones (interconnections), where only 24% of the new power plants seeking grid connections between 2000 and 2015 were subsequently completed³. The typical waiting period before a grid connection was granted increased from around 1.9 years to around 3.5 years in the last decade [7]. Solar (462 GW or 61%) and wind (209 GW or 28%) projects formed the largest share of power plants waiting to be connected. In the UK, wind and solar developers face delays of between 6 and 10 years because of constraints in transmission infrastructure [8]. At all these locations, limited grid capacity presents an immediate challenge to the integration of new renewable generation and therefore to decarbonisation of the electricity system.

When interviewed about the capacity shortage in the Dutch grid, the Director of Policy and Energy Transition at Netbeheer Nederland⁴, responded that “*It is better to site a solar park next to an energy-guzzling data center than in a remote area*”[9]⁵. That is also the broader motivation driving this thesis, where new solar generation is planned at EV charging locations: existing carparks.

This thesis contributes towards understanding how solar carparks for EV charging at these existing carpark locations can help integrate both solar energy and electrification of passenger mobility despite scarce capacity in the Dutch grid.

In **Chapter 3**, several scheduled charging methods with MPC were investigated to reduce peaks in energy exchanged with the grid. The scheduling of charging was found to achieve between 16% and 39% reduction in demand peaks. It is likely that measures such as the recently enforced 70% and then 50% lower grid capacity for solar projects will also be applied to parking lots with a large number of EV chargers⁶. The investigated scheduled charging methods would enable the lower available capacity at such locations to be more effectively used.

In **Chapter 4**, an offgrid solar array was investigated for the charging of vehicles at long term parking locations. As the situation stands, currently in the Netherlands, there may be significant delays before a grid connection is provided and a very real possibility that permission for a grid connection may be denied. Offgrid charging enables rapid planning of projects, removing the uncertainty and delays as well as costs associated with a grid connection. The proposed algorithms can enable the adequate charging all

3 For wind (19%) and solar (16%), the completion rates were even lower.

4 Netbeheer Nederland is the consortium of Dutch DSOs.

5 In the original Dutch, “*Een zonnepark kan bijvoorbeeld beter naast een energielurpend datacentrum worden geplaatst dan in een afgelegen gebied*”.

6 This is a likely policy measure to be enforced in the medium term, 5 to 7 years. The necessary pre-requisite for such a measure to be taken is smart/controlled charging infrastructure at the parking lot. Smart charging is expected to become a norm for charging infrastructure in the Netherlands from 2025 [10].

plugged vehicles for most of the year except during *dunkelflautes*, when electricity supply is also likely to be scarce and therefore expensive in the grid.

With the broader objective of decarbonisation of both the electricity grid and of passenger mobility, chapters in this thesis describe how and by how much these emissions are reduced at solar carports and by EV fleets.

Chapter 5 describes the extent of contribution of solar carports to offsetting of greenhouse gas emissions. By *enabling new solar projects to be integrated*, their impact on carbon offset is likely to be even larger.

The results from **Chapter 6** suggest that although cost-based optimisation does not lead to large differences in carbon intensity over the year in the current Dutch grid, EVs fleets are systemically well suited to respond to demand response. These characteristics at a large scale are extremely desirable from the perspective of a future electricity grid with a high share of renewables, in which vehicles will need to respond to the increased variance of prices as a result of higher variability in energy supply.

Finally, we investigate how recent developments in EV charging technology: vehicle-to-grid, can be made more acceptable and therefore more widely adopted in society.

The insights from **Chapter 7** suggest that the use of EVs for demand side storage in addition to demand response is already acceptable to some current EV drivers. It also clearly describes the conditions under which V2G charging would be more acceptable to a broader group of users as well as for future adopters of EVs.

8.3 RECOMMENDATIONS AND OUTLOOK

This thesis provides the evidence for making several recommendations for system designers and policy makers. A brief outlook on Dutch policy influencing solar carports for EV charging is also provided.

8.3.1 RECOMMENDATIONS

1) Promote the construction of solar carports at large workplace parking lots where EVs charge

Buildings with large workforces generally have correspondingly large parking lots located adjacent to them. Due to the existing building's electricity needs, the locally available grid capacity is high. When EV charging is needed, the typical electric vehicle energy requirements are low, being linked with commuter ranges of the order of a few tens of kilometres. These locations are favourable for the construction of solar carports, with very little need for upgrades at the distribution level grid since the EVs and the building generally use all the solar energy produced. The challenge of high power of charging,

linked with the simultaneity of arrival times of vehicles is partially reduced by the solar production. Due to the durations of charging typically being in the range of a working shift of 8 hours, high power peaks can further be reduced by scheduled charging, as described in this thesis.

2) Use solar energy for charging of EVs at long term (>24 hours) parking lots

As shown in this thesis, a minimal grid connection is sufficient for charging EVs to full states of charge if solar carports are constructed at longterm parking lots. This is of considerable value at locations like airports. Airports are typically extremely large consumers of electricity, often operating at the limits of local power capacity. Solar carparks with very low power capacity needed for charging present an alternative to immediate charging from the grid. This avoids the capacity upgrades at the distribution level which would be needed if immediate charging was used at long term parking.

3) Do not include batteries within solar carports

In Dutch and northwestern European climates, batteries coupled with solar arrays tend to be full in the summer and close to empty in the winter. This is linked with the fact that the solar insolation received in June is about ten times that received in December. Since this is a function of the local geography, it is common across all solar production plants in the region. This leads to the case where, in summer, solar energy can generally directly meet the daytime loads in the parking lot without the need for storage. On the other hand, in winter, when solar production is too low to meet the load, it is also too low to charge the battery to a state of charge needed to meet the load. Since there is not enough energy to store, increasing the energy storage capacity does not address this problem. Alternative uses of the battery, such as carbon offset are also affected by this phenomenon, reducing the functional value of the battery storage. Batteries can be used for peak reduction at locations with low grid capacity, such as in solar-storage projects. However, this is not the case for solar carparks, where the solar peaks can be used behind the meter in the buildings which are always adjacent to large parking lots. Because of their negligible added value, it is recommended not to include batteries within solar carport projects.

8.3.2 POLICY OUTLOOK RELATED TO SOLAR CARPARKS IN THE NETHERLANDS

In the Netherlands, policies at various levels have affected the rollout of solar carparks. In 2019, a consultation was held by the Netherlands Environmental Assessment Agency⁷, on whether solar carparks should form a separate category of solar PV projects within the nationally centralised SDE++ subsidy mechanism. The formation of a separate category was ruled out due to the higher costs per unit generation capacity associated with the construction of the carport canopy in comparison with rooftop and

⁷ In the original Dutch, Planbureau voor de Leefomgeving (PBL)

groundmounted PV systems, all of which competed for the same funds. Solar carport projects remained categorised together with other building-mounted solar projects [11].

The costs of electricity transmission, the delays associated with reinforcing lines and the lack of grid capacity for large groundmounted solar parks were not considered in the early development of the solar sector. The allocation of funding based on costs of installed generation capacity led to the siting of PV projects in remote locations which face transmission bottlenecks and is now resulting in power curtailment. In order to avoid this, applications for SDE++ funding for renewable electricity projects since 2021 have been required to include an indication from the the grid operator that sufficient transmission capacity is available for the proposed project site [12]. This requirement is likely to lead to more solar projects in the built environment, where the available transmission capacity has historically been higher.

The results obtained in this thesis show that the coupling of solar carparks enable integration of solar photovoltaics in the built environment and reduce the grid capacity needed for EV charging at workplaces. Further, solar carparks have several positive externalities such as enabling the electrification of transport and the double-use of land used for parking vehicles⁸. These benefits may also be shared with other building-mounted (such as rooftop and façade) solar projects which can deliver power to charge EVs in the building's parking lots.

Individual Dutch provinces currently provide incremental funding for solar carport projects in recognition of these benefits [13, 14]. Additionally, the central government subsidises electric vehicle charging stations through the Green Deal C-185 [15] and has offered tax reductions for the electricity used for EV charging since 2017 [16]. This can be managed more efficiently through the central SDE++ mechanism. In this light, a separate category within the SDE++ mechanism for solar photovoltaic projects that enable EV charging should be considered, with a focus on workplaces with commuting EVs and businesses with EV fleets. It is essential that other building-mounted solar photovoltaic systems which can deliver the same benefits (i.e. the availability of an existing grid connection, the reduction in additional grid capacity needed for EV charging and the double use of land) be included in the same category for price-based competition with solar carport systems.

8.4 FUTURE RESEARCH

Several interesting directions for future research emerge from this work. The investigations into the configurations of solar carparks for EV charging in **Chapters 3** and **4** were limited to technical analyses. There is potential for techno-economic analyses to build on the

⁸ In contrast, projects outside the built environment often make use of agricultural land, natural reserves, etc.

studies here to investigate business cases and financial analyses. Similarly, although the focus here was on technical designs to operate with scarce grid capacity, the application of more economics-based approaches could lead to thinking about more efficient allocation of the scarce resource through markets or planning.

For the scheduling of EV fleets, the approaches considered in this work were limited to single objective formulations. However, due to the limited financial benefits on single objectives (and single markets), there is a trend in the EV charging industry to shift towards “*stacked services*”. These stacked services involve the bundling of a large number of value propositions for EV users as well as the bundling of several streams of revenue from the energy markets for EV aggregators. While the stacking of services increases the revenue per EV, increased system complexity, and correspondingly lower understanding of it by the end user, are known to lead to poorer consumer acceptance of demand response. There is thus a trade-off between maximising the revenue for the aggregator based on a given number of EVs and making the service acceptable to the maximum number of EV drivers. Investigation of stacked services are therefore interesting both from a mathematical formulation and optimisation perspective as well as from a consumer acceptance perspective.

For the calculation of carbon offset and the use of demand response to increase it, the availability of publicly accessible and validated data and well defined methods for calculations at the individual project level are lacking. A broader description of this issue is provided by Hamels et al. [17]. Due to the lack of shared data and universally applied methods, there is low transparency of the calculation process and low comparability of results. This also leads to low trust in the results obtained. For the effective use of aggregated demand response to offset carbon in the electricity grid or the efficient allocation of funding based on the metric of offset emissions, further work is needed to create publicly accessible data as well as to develop standardised methods.

The results obtained for consumer acceptance of V2G are limited to early adopters of EVs. This subset of the larger vehicle driving population is characterised by high education, wealth, ownership of parking space, enthusiasm for technology, environmental awareness and a high fraction of males. Future research can help to investigate the consumer acceptance within the broader population of vehicle drivers.

REFERENCES

- [1] Molengraaf, P., Voorhorst, B., *Convenant Zon Betaalbaar op het Net*. Holland Solar and Netbeheer Nederland, 2020. URL: <https://www.nvde.nl/wp-content/uploads/2020/11/convenant-zon-betaalbaar-op-het-net.pdf>.
- [2] Lensink, S. *Eindadvies basisbedragen SDE++ 2022*. The Hague, the Netherlands: Netherlands Environmental Assessment Agency (Planbureau voor de Leefomgeving), 2022. URL: <https://www.pbl.nl/sites/default/files/downloads/pbl-2022-eindadvies-sde-plus-plus-2022-4403.pdf>.
- [3] Netherlands Enterprise Agency (RVO), *SDE++ 2022: Stimulering Duurzame Energieproductie en Klimaattransitie, Openstelling van 28 juni t/m 6 oktober 2022*. RVO-003-2022/BR-DUZA. Zwolle, the Netherlands: Netherlands Enterprise Agency (RVO), 2022. URL: https://www.rvo.nl/sites/default/files/2022-06/Brochure_SDE_plus_plus_2022_versie_27_06_2022.pdf.
- [4] TenneT, *Voorlopige stop voor nieuwe grootverbruikers van elektriciteit in Noord-Brabant en Limburg*. 2022. URL: <https://www.tennet.eu/nl/tinyurl-storage/nieuws/voorlopige-stop-voor-nieuwe-grootverbruikers-van-energie-in-noord-brabant-en-limburg/>.
- [5] TenneT, *Annual Market Update 2020: Electricity market insights*. Arnhem, the Netherlands, 2021. URL: https://www.tennet.eu/fileadmin/user_upload/Company/Publications/Technical_Publications/Annual_Market_Update_2020.pdf.
- [6] Federal Network Agency of Germany (Bundesnetzagentur), *Monitoring Report 2021*. 2022. URL: https://www.bundesnetzagentur.de/SharedDocs/Downloads/EN/Areas/ElectricityGas/CollectionCompanySpecificData/Monitoring/MonitoringReport2021.pdf?__blob=publicationFile&v=2.
- [7] Rand, J., Bolinger, M., Wiser, R., Jeong, S., *Characteristics of Power Plants Seeking Transmission Interconnection as of the End of 2020*. Lawrence Berkeley National Laboratory, 2021, p. 24.
- [8] Plimmer, G. "Renewables projects face 10-year wait to connect to electricity grid." In: *Financial Times* (2022). URL: <https://www.ft.com/content/7c674f56-9028-48a3-8cbf-c1c8b10868ba>.
- [9] Kraan, J. "Nauwelijks meer ruimte voor zonneparken op bomvol stroomnet." In: *NU* (2021). URL: <https://www.nu.nl/klimaat/6167439/nauwelijks-meer-ruimte-voor-zonneparken-op-bomvol-stroomnet.html>.
- [10] Heijnen, V. *Regionale uitrol laadinfrastructuur*. Letter. 2022. URL: <https://www.rijksoverheid.nl/binaries/rijksoverheid/documenten/kamerstukken/2022/06/15/regionale-uitrol-laadinfrastructuur/regionale-uitrol-laadinfrastructuur.pdf>.
- [11] Lemmens, J., Beurskens, L., Lensink, S., *Conceptadvies SDE++ zonne-energie*. The Hague, the Netherlands: Netherlands Environmental Assessment Agency (Planbureau voor de Leefomgeving), 2020. URL: https://www.google.com/url?sa=t&rct=j&q=&esrc=s&source=web&cd=&cad=rja&uact=8&ved=2ahUKEwjC_-L3PT0AhXJiP0HHRdoCA0QFnECA4QAQ&url=https%3A%2F%2Fwww.pbl.nl%2Fsites%2Fdefault%2Ffiles%2Fdownloads%2Fpbl-2020-conceptadvies-sde-plus-plus-zonne-energie_4104.pdf&usg=AOvVaw0T7k-k4egwoHa6Evpl9lco.
- [12] Netherlands Enterprise Agency (RVO), *SDE++ 2021 Stimulation of Sustainable Energy Production and Climate Transition*. The Hague, the Netherlands: Netherlands Ministry of Economic Affairs and Climate Policy, 2021. URL: https://english.rvo.nl/sites/default/files/2021/10/SDEplusplus-oktober_2021_ENG.pdf.
- [13] Provincie Noord-Holland, *Provincie investeert in zonnepanelen op parkeerterreinen - Provincie Noord-Holland*. Last Modified: 2022-01-28 Publisher: Noord-Holland. 2022. URL: https://www.noord-holland.nl/Actueel/Archief/2022/Januari_2022/Provincie_investeert_in_zonnepanelen_op_parkeerterreinen.
- [14] Provincie Utrecht, *Provinciale uitbreiding subsidiemogelijkheden Energietransitie*. 2022. URL: <https://rtvstichtsevecht.nl/nieuws/artikel/provinciale-uitbreiding-subsidiemogelijkheden-energietransitie>.

- [15] Rijksoverheid, *Green Deal - Openbaar Toegankelijke Elektrische Laadinfrastructuur*. 2018. URL: <https://www.greendeals.nl/sites/default/files/downloads/GD185-Openbaar-toegankelijke-elektrische-laadinfrastructuur.pdf> (visited on 07/13/2022).
- [16] Dutch Tax Authority (Belastingdienst), *Tabellen tarieven milieubelastingen*. 2022. URL: https://www.belastingdienst.nl/wps/wcm/connect/bldcontentnl/belastingdienst/zakelijk/overige_belastingen/belastingen_op_milieugrondslag/tarieven_milieubelastingen/tabellen_tarieven_milieubelastingen.
- [17] Hamels, S., Himpe, E., Laverge, J., Delghust, M., Van den Brande, K., Janssens, A., Albrecht, J., "The use of primary energy factors and CO2 intensities for electricity in the European context - A systematic methodological review and critical evaluation of the contemporary literature." In: *Renewable and Sustainable Energy Reviews* 146 (2021), p. 111182. ISSN: 1364-0321. DOI: 10.1016/j.rser.2021.111182. URL: <https://www.sciencedirect.com/science/article/pii/S1364032121004706>.

ACKNOWLEDGMENTS

Over these last few years in Delft, I've been fortunate enough to meet and interact with a large number of people who have supported me along the way. These connections have been an invaluable part of my PhD experience, and the story of this thesis would not be complete without mention of their names.

I owe special thanks to my promoters, Prof. Ad van Wijk and Prof. Zofia Lukszo. Prof. van Wijk, who gave me the opportunity to join the Future Energy Systems group in Delft, has stood with me from start to finish. From him, I learnt what the role of a scientist is in the world outside the University, how important that role is and how not to lose sight of the bigger picture. From Prof. Lukszo, I learnt academic rigour: precision and conciseness in both language and mathematical formulation, the attention to detail required of an expert and how to finish the projects I so enthusiastically began.

Outside academia, I worked on the PowerParking project, where I benefited from collaboration with the other members of the project consortium. Karin Maatje, of the Province of Flevoland, was continuously supportive: working with her was a pleasure, whether in Flevoland or in Barcelona. With Dennis Meerburg, Jasper Feuth and Esger Schouten, I had many enjoyable and instructive discussions about solar carparks, project management and business cases over the many years of our collaboration.

I was lucky enough to engage with several talented fellow students at TU Delft over their Master theses: I only hope they enjoyed working with me as much as I did working with them. Their insights, questions and hard work both challenged and motivated me. For rewarding collaborations, I thank Yitzi Snow, Marnix Paanakker, Edward Heath, Chaturika Chowdhary Kota and Kaja Tegtmeier, who all worked on energy system analysis, and Koen van Heuveln, Enes Başer and Koen Nijssen, who focused on V2G. I am forever grateful to Kaja and Edward, both of whom were brave enough to climb up ladders with me to high spots in order to install pyranometers, and kind enough to drive me around to fill up hydrogen in the project car I worked with. I am also thankful for the experiences shared with Koen (van Heuveln) and Kaja, with both of whom I worked extensively on entrepreneurial projects well beyond their thesis work.

Over the first two years in Delft, I worked alongside Carla Robledo, Nikolaus Chrysochoidis Antsos, Samira Farahani and Vincent Oldenbroek, to whom I am grateful for their invaluable help in the early stages of my PhD and the easy camaraderie we shared in the Future Energy Systems research group.

At The Green Village, I had the chance to test out many of systems I researched, and enjoyed a great deal of support from several people, without whom several parts of the research in this thesis would not have been possible. These include Willy Spanjer and

Lidewij van Trigt, who were always there for either project support or a chat, Tim Jonathan, who always knew exactly where everything on the terrain was, Rene Tamboer and Marjan Kreijns, for ensuring I always knew who to talk to and Aad Beloo, whose knowledge of cars and how to get things done were of immense help. I'd also like to thank David Salek, at SurfSARA, for his continuous help with all things related to data collection, and to Joep van der Weijden, who later took on some of this role.

During another project I worked on during the PhD years, involving the hydrogen car, I had the chance to work with several industrial partners. From AquaBattery, I thank Juan Sebastián Álvarez and Francesca Corvaglia, who worked to get the salt water flowing, and Jiajun Cen for many interesting conversations and excellent advice. From ZOWN/Firan, I enjoyed investigating microgrids with Elizabeth Vandeventer and spending many months with Cees Jan Dronkers and Ricardo de Wijs, getting *our* microgrid in the Green Village to work. From Dot Robot, I was glad to meet and work alongside María García Fernández and Willem Zwetsloot, as we got our respective control systems to function.

While working on the Technology Collaboration Programme from the International Energy Agency, I had the opportunity to broaden my horizons, collaborating with academics from all around the globe. I'd like to thank in particular, Dr. Selin Yilmaz, Dr. Sophie Adams, Dr. Declan Kuch, Dr. Christian Winzer and Lisa Diamond for the detailed insights into their respective research areas, which undoubtedly led to many improvements in my own.

At DEMO, I am deeply indebted to Rajeev Bheemireddy, the Raspberry Pi genius, and Lars Leenheer, who supported me in my various attempts to get hardware systems to function. I'd also like to thank Bert ten Haaf at Soltronergy, with whom I installed an inverter in the December rain under a tarpaulin and Dr. Roland Valkenburg at TNO, who remains my go-to-guy for any questions I ever have about solar inverters. I also thank Jaap Willems, at MijnDomijn, whose interest in my research meant I had a free rein to experiment with a V2G battery without worrying about vehicle warranties. At Process and Energy, I'd like to thank Jaap van Raamt and Michel van der Brink for ensuring the experiments could always run on schedule, and to Rob van den Boogaard, who always helped to find a solution.

I'd also like to thank the many researchers I co-authored articles with, including Dr. Jan Anne Annema, Mylene van der Koogh, Prof. Bert van Wee and Dr. Udo Pesch at the Faculty of Technology Policy and Management in TU Delft, Esther van Bergen at Cenex Nederland and Dr. Brecht Baeten at Enervalis.

During my PhD, I was lucky to be in 34 K-1-290, widely known as the best (and noisiest) room in Process and Energy. I will always remember with great fondness shooting Gustavo, eating cakes with Vilborg, being Noura's favourite paranymp, tapping balloons with Fatma, pushing Nikos around in a shopping cart, swimming to safety with Stephan and Simone, watching Karsten tear a sponge, singing with Mengmeng, teaching Marko, Joe and Heng how to dance, dressing up for Carnaval with

Luis and Ursa, discovering new greetings with Suriya, playing pingpong with Jie and Mohammed, fixing bikes with Rumen, eating Reza's mum's cooking, and attending Vincent's wedding. I am also delighted to have met and spent time with Hugo, Uttiya, Elyas, Hakan, Johan, Seyed, Ben, Pietro, Asif and Wouter. I will miss in particular our fascinating conversations at lunch, extended coffee breaks, office yoga sessions, Bring Sally Up challenges, COVID lunches and elaborate Secret Santas.

For several years, I planned and organised events at Young Delft, the events organisation for young TU Delft employees, where I made several friends. For the many fun events and all the beer tokens, I thank: Manas, who later organised and participated in the Friday COVID bubble, Christian, Anna, Anne, Alessandro, Claire, Maideh and Roberto.

I'd like to thank Vasishta and Hanne for being there for me throughout my time in the Netherlands, even when I lost my shoes while crossing the sands of the North Sea. I'm grateful to Francesco and Jane, with whom I sheltered during the storm that was COVID-19, and to Giulia, with whom I learnt Danish and filled the house with balloons, for their warmth and friendship at home. Many thanks as well to Varun for his enthusiastic response when I asked him to design my cover page, and the time and effort he put in after hours on the project.

I'm also very thankful to Yuki, Abhas, Daniel and Aniket, with whom I had a lot of fun both on the tennis courts and off it. I also greatly enjoyed yoga with María, running with Nati, padel with Donato and badminton with Döme. I'd like to thank Marta, Emilia, Simon, Khatereh, Maria, Parsa, Indushree and Sylvia for being wonderful friends.

The friendships I found at Kanaalweg 3A, my first house in Delft, have continued long after. Bianca, Mehmet, Shahrzad, Joe, Lucy, Tim, Marilia, Guillermo, Giacomo, Lisa, Fabi and Mark, you made Delft a warmer and more welcoming place. For my Dutch language skills, I'd like to thank my conversation group members, John and Amine, with whom I still think it's more natural to speak in Dutch.

Finally, I am deeply grateful for the support that my parents, Nitya and Sanjeev, have offered me, unwavering and unconditional, over all these years and in more ways than I could possibly count. And to my sister, Nayantara, who has always been there for me. I'd also like to thank my dear Patti, who unfortunately did not survive to see me receive the doctorate though she so wanted to, and to Allu Patti who had been pushing everyone in the family to get a doctorate for years. To Aie, who has long told me she wanted me to get a PhD, thank you for keeping the faith strong. And to Ramani Anna, who told me to get a PhD as soon as I finished my Masters, I'm happy I did.

Rishabh Ghotge,
August 2022, Delft.

CURRICULUM VITÆ



RISHABH GHOTGE

Ph. no: +31 687929229

Email address: r.ghotge@tudelft.nl

Email address: ghotge.rishabh@gmail.com

EDUCATION

2018–2022	Ph.D, Delft University of Technology, Delft, the Netherlands
2015–2017	M.Sc. in Renewable Energy, Carl von Ossietzky University, Oldenburg, Germany
2011–2015	B.Tech., Mechanical Engineering, Manipal Institute of Technology, Manipal, India

WORK EXPERIENCE

Since 2020	Founder of Heliostrome, a startup to develop software to enable the better design of solar irrigation systems
2017–2018	Researcher, Delft University of Technology, Delft, the Netherlands
2016–2017	Intern at the Solar Energy Application Centre (SEAC), Eindhoven, the Netherlands
2015	Intern at Scorpius Trackers, Pune, India
2014	Intern at the Leibniz Institute of Agricultural Engineering, Potsdam, Germany

LANGUAGE SKILLS

Native speaker	English, Hindi, Marathi
Other languages	Dutch (B1), German (A2)

COMMUNICATION, ORGANISATION AND MANAGEMENT

2017–2022	Event Manager at Young Delft, the organisation for young people working at TU Delft
2012–2014	Creative Director of Dramanon Manipal, a theatre company
2013	English language school teacher as a volunteer in China

COMPUTER SKILLS

- 1) Programming skills in Python
- 2) Solar irradiance and photovoltaic power forecasting with PVLIB Python
- 3) PV and Hybrid System Design, Dimensioning and Simulation with HOMER Pro, PVLIB and SAM
- 4) Basic Geographical Information System mapping in QGIS

PRIZES AND AWARDS

2022	2nd place, EIT Food Innovator Fellowship Hackathon, pitch competition in an EU-supported programme training researchers to convert scientific ideas into business in the agri-food sector.
2021	Top 3, National Finals, the Netherlands, KIC Climate LaunchPad, the world's largest green business ideas competition.
2021	Q-Park Student Award, Maastricht, the Netherlands, for best Master thesis in the field of parking (supervised one of the winning students, Edward Heath)
2019	Finalist, Futureproofing for the Water Crisis Hackathon, Asian Development Bank, Manila, the Philippines, a pitch competition for ideas to help address global water challenges.

HOBBIES

Travelling, Playing tennis and squash, Reading, Cooking

LIST OF PUBLICATIONS

- [1] **Ghotge, R.**, Nijssen, K. P., Annema, J. A., Lukszo, Z., “Use before You Choose: What Do EV Drivers Think about V2G after Experiencing It?” In: *Energies* 15.13 (2022). Number: 13 Publisher: Multidisciplinary Digital Publishing Institute, p. 4907. ISSN: 1996-1073. DOI: 10.3390/en15134907
- [2] Adams, S., Diamond, L., Esterl, T., Fröhlich, P., **Ghotge, R.**, Hemm, R., Henriksen, I. M., Katzeff, C., Kuch, D., Michellod, J. L., Lukszo, Z., Nijssen, K., Nyström, S., Ryghaug, M., Winzer, C., Yilmaz, S., *Social License to Automate: Emerging Approaches to Demand Side Management*. IEA User-Centred Energy Systems Technology Collaboration Programme, 2021. DOI: 10.47568/4XR122
- [3] **Ghotge, R.**, Wijk, A., Lukszo, Z., “Off-grid solar charging of electric vehicles at long-term parking locations.” In: *Energy* 227 (2021), p. 120356. ISSN: 0360-5442. DOI: 10.1016/j.energy.2021.120356
- [4] Heuveln, K., **Ghotge, R.**, Annema, J. A., Bergen, E., Wee, B., Pesch, U., “Factors influencing consumer acceptance of vehicle-to-grid by electric vehicle drivers in the Netherlands.” In: *Travel Behaviour and Society* 24 (2021), pp. 34–45. ISSN: 2214-367X. DOI: 10.1016/j.tbs.2020.12.008
- [5] Heath, E., **Ghotge, R.**, Wijk, A., “Solar Charging Electric Vehicles: Analysing the Charging Efficacy of an Off-Grid Solar Powered Electric Vehicle Charging Systems in Long Stay Parking Applications.” In: *Proceedings of the EU PVSEC 2020 (Online)*. 37th European Photovoltaic Solar Energy Conference and Exhibition. Online: EU PVSEC, 2021, pp. 1874–1879. ISBN: 3-936338-73-6. DOI: 10.4229/EUPVSEC20202020-6BV.5.32
- [6] **Ghotge, R.**, Snow, Y., Farahani, S., Lukszo, Z., Wijk, A., “Optimized Scheduling of EV Charging in Solar Parking Lots for Local Peak Reduction under EV Demand Uncertainty.” In: *Energies* 13.5 (2020). Number: 5 Publisher: Multidisciplinary Digital Publishing Institute, p. 1275. ISSN: 1996-1073. DOI: 10.3390/en13051275
- [7] **Ghotge, R.**, Paanakker, M., Baeten, B., Lukszo, Z., Wijk, A., “The Effect of Price-Optimized Charging on Electric Vehicle Fleet Emissions.” In: 2020 IEEE PES Innovative Smart Grid Technologies Europe (ISGT-Europe). the Hague, the Netherlands: IEEE, 2020, pp. 469–473. ISBN: 978-1-72817-099-2. DOI: 10.1109/ISGT-Europe47291.2020.9248907

- [8] **Ghotge, R.**, Wijk, A., Vandeventer, E., Álvarez, J. S., “A Global Analysis on Microgrids through the PESTEL Framework.” In: *2020 IEEE International Conference on Power Electronics, Smart Grid and Renewable Energy (PESGRE2020)*. 2020 IEEE International Conference on Power Electronics, Smart Grid and Renewable Energy (PESGRE2020). Kochi, India: IEEE, 2020, pp. 1–5. ISBN: 978-1-72814-251-7. DOI: 10.1109/PESGRE45664.2020.9070725
- [9] **Ghotge, R.**, Wijk, A., Lukszo, Z., “Challenges for the design of a Vehicle-to-Grid Living Lab.” In: *2019 IEEE PES Innovative Smart Grid Technologies Europe (ISGT-Europe)*. 2019 IEEE PES Innovative Smart Grid Technologies Europe (ISGT-Europe). Bucharest, Romania: IEEE, 2019, pp. 1–5. ISBN: 978-1-5386-8218-0. DOI: 10.1109/ISGTEurope.2019.8905503
- [10] **Ghotge, R.**, Wijk, A., “Long term electric vehicle parking for behind-the-meter storage of solar energy - A simulation study.” In: *Proceedings of the EU PVSEC 2019 (Marseille)*. 36th European Photovoltaic Solar Energy Conference and Exhibition. Marseille, France: EU PVSEC, 2019, p. 5. ISBN: 3-936338-60-4. DOI: 10.4229/EUPVSEC20192019-6C0.15.6



A solar carport with vehicle-to-grid (V2G) charging at the Green Village, TU Delft